

The Project Gutenberg EBook of Things To Make, by Archibald Williams

This eBook is for the use of anyone anywhere at no cost and with almost no restrictions whatsoever. You may copy it, give it away or re-use it under the terms of the Project Gutenberg License included with this eBook or online at [www.gutenberg.net](http://www.gutenberg.net)

Title: Things To Make

Author: Archibald Williams

Release Date: January 11, 2005 [EBook #14664]

Language: English

Character set encoding: ASCII

\*\*\* START OF THIS PROJECT GUTENBERG EBOOK THINGS TO MAKE \*\*\*

Produced by Don Kostuch

# THINGS TO MAKE



Transcriber's Note:

If the pdf version of the book is viewed using facing pages with even numbered pages on the left, you will see a close approximation of the original book.

Notations of the form "(1,650) 2" appear at the bottom of some pages; they are probably printer's references for assembling to book.

The text only version is of limited use because of the many figures used. I recommend the pdf or rtf versions.

Some of the projects should be approached with care since they involve corrosive or explosive chemicals, electricity and steam boilers.

***Do not use lead solder, particularly on cooking utensils.***

Whether you simply want to travel back into the mind of a young boy at the beginning of the twentieth century, or want to try your hand at some interesting projects in carpentry, machinery, kites and many other areas, have fun.

The following four pages have definitions of unusual (to me) terms used frequently in the text.

## **Terms**

Batten - Narrow strip of wood.

Benzoline - An impure benzene; colorless, flammable, liquid aromatic hydrocarbon, C<sub>6</sub>H<sub>6</sub>.

Bevel (Bevelling) - A cut that is not a right angle.

Bradawl - Awl with a beveled tip to make holes in wood for brads or screws.

Chamfer - Cut off the edge or corner; bevel.

Boss - Enlarged part of a shaft where another shaft is coupled or a wheel or gear is keyed.

Broach - To shape a hole with a tapered tool.

Carbide - Calcium carbide, used to produce acetylene (C<sub>2</sub>H<sub>2</sub>) gas for lighting and welding.

Compo - "Composition", like plastic.

Creosote - An oily liquid containing phenols and creosols, obtained from coal tar. Used as a wood preservative and disinfectant. Can cause severe neurological disturbances if inhaled.

Deal - A fir or pine board of standard dimensions

Fish-plate - A plate bolted to the sides of two abutting railroad tracks.

Fretworking - Ornamental design, often in relief.



Gasholder

Gasometer - Storage container for fuel gas, especially a large, telescoping, cylindrical tank.

Gland - The outer sleeve of a stuffing box that prevents leakage past a moving machine part.

Glass paper - Paper faced with pulverized glass, like sandpaper.

Gudgeon - A metal pivot or journal at the end of a shaft or an axle, around which a wheel or other device turns.

Joiner - A cabinetmaker.

Linoleum - A floor covering made in sheets by pressing heated linseed oil, rosin, powdered cork, and pigments onto a burlap or canvas backing.

Lissom - Easily bent; supple

Longitudinal - Relating to length.

Mortice - Cavity in a piece of wood or other material, prepared to receive a tenon and form a joint.

Panel saw - Handsaw with fine teeth.

Pinion - Gear with a small number of teeth designed to mesh with a larger gear.

Plinth - Architectural support or base.

Rasp - Coarse file with sharp, raised, pointed projections.

Sleeper - Railroad crosstie.

Spanner - Wrench

Spirit Lamp - Alcohol lamp; see example on page 188.

Spirit - Alcohol

Strake - Ridge of thick planking on the side of a wooden ship.

Strut - Any part designed to hold things apart or resist compressive stress;

Tap - Cut screw threads

Tenon - Projection on the end of a piece of wood shaped for insertion into a mortise to make a joint.

Tenon saw - Saw with a thin blade for cutting tenons.

Tinning - Coating with soft solder.

Turner - Person who operates a lathe or similar device.

Tyre - Tire

Vestas - Matches; Vestal is the Roman goddess of the hearth, worshiped in a temple containing the sacred fire tended by the vestal virgins.

## Currency Conversion

Prices are quoted in old English currency,  
pounds, shillings, pence.

"12s. 6d." is read as "12 Shillings and 6 Pence."

Pence/penny

Shilling - 12 pence.

Crown - 5 shillings.

Pound - 20 shillings.

Guinea - 21 shillings.

The approximate value of 1900 prices in 2002 is:

1900 Unit	Value in 2002 Currency	
	English Pound	US Dollars
Pence	.26	.48
Shilling	3.10	5.80
Crown	15.50	29.00
Pound	62.00	116.00

[End Transcriber's note.]

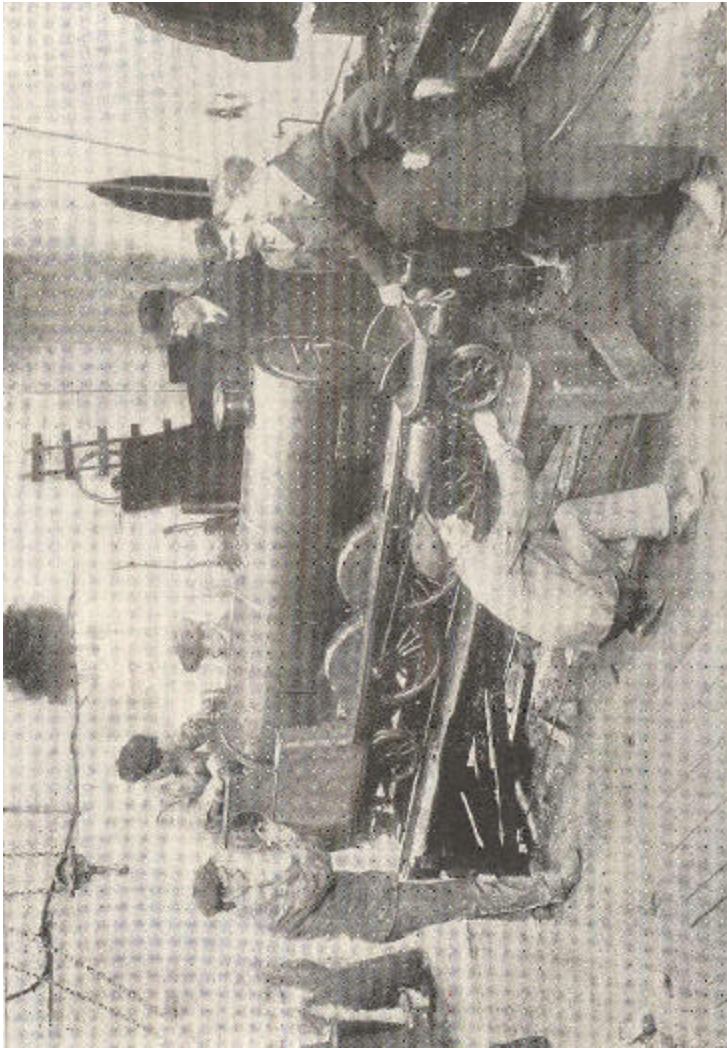

*Photo: Daily Mirror.*

Large model locomotive built for one of the royal princes of Siam by Messrs. Bassett-Lowke, Limited. It is one-quarter the size of a modern express engine; weighs two tons, with tender; is fifteen feet long; will pull seventy persons; and has a highest speed of about thirty miles an hour.

# THINGS TO MAKE

BY

ARCHIBALD WILLIAMS  
AUTHOR OF  
"VICTORIES OF THE ENGINEER,"  
HOW IT WORKS,"  
"HOW IT IS MADE,"  
ETC., ETC.

THOMAS NELSON AND SONS, LTD.

LONDON, EDINBURGH, AND NEW YORK

The making for oneself of toys and other objects of a more or less useful character has certain advantages over buying them. In the case of the more elaborate and costly articles, it may enable one to possess things which otherwise would be unobtainable. Secondly, a home-made article may give a satisfaction more lasting than is conferred by a bought one, though it may be less beautiful to look upon. Thirdly, the mere making should be a pleasure, and must be an education in itself.

To encourage readers to "use their hands" the following chapters have been written. The subjects chosen provide ample scope for the exercise of ingenuity and patience; but in making my selection I have kept before me the fact that a well-equipped workshop falls to the lot of but a few of the boys who are anxious to develop into amateur craftsmen. Therefore, while the easiest tasks set herein are very easy, the most difficult will not be found to demand a very high degree of skill, or more than a very moderate outlay on tools. I may say here that I have been over the ground myself to find out its difficulties for my readers, and that I made an engine similar to that described in Chapter XV (the most elaborate mechanism included in the book) with

very simple tools. Some of the items which I had on my original list were abandoned, because they presupposed the possession of comparatively expensive machines.

My selection has also been guided by the desire to cater for different tastes. In some cases the actual manufacture of the thing described may be regarded as the most instructive and valuable element, and may appeal most forcibly to the "handy" boy; in others--the Harmonograph provides a good instance - the interest centres round the experiments made possible by the construction of a simple piece of apparatus; in some the utility of the article manufactured is its chief recommendation.

I feel certain that anyone who follows out the pages of this volume with hand as well as with eye, will have little reason to regret the time so spent. The things made may in course of time be put aside and forgotten, but the manual skill acquired will remain. Nowadays one can buy almost anything ready-made, or get it made without difficulty; yet he who is able to make things for himself will always have an advantage over the person to whom the use of tools is an unprobed mystery.

- I. SAWING TRESTLE 7
- II. A JOINER'S BENCH 13
- III. A HANDY BOOKSTAND 23
- IV. A HOUSE LADDER 27
- V. A DEVELOPING SINK 33
- VI. A POULTRY HOUSE AND RUN 39
- VII. A SHED FOR YOUR BICYCLE 49
- VIII. A TARGET APPARATUS FOR RIFLE SHOOTING 65
- IX. CABINET-MAKING 68
- X. TELEGRAPHIC APPARATUS 83
- XI. A RECIPROCATING ELECTRIC MOTOR 95
- XII. AN ELECTRIC ALARM CLOCK 103
- XIII. A MODEL ELECTRIC RAILWAY 109
- XIV. A SIMPLE RECIPROCATING ENGINE 127
- XV. A HORIZONTAL SLIDE-VALVE ENGINE 136
- XVI. MODEL STEAM TURBINES 165
- XVII. STEAM TOPS 187
- XVIII. MODEL BOILERS 195
- XIX. QUICK-BOILING KETTLES 224



- XX. A HOT-AIR ENGINE 232
- XXI. A WATER MOTOR 247
- XXII. MODEL PUMPS 255
- XXIII. KITES 267
- XXIV. PAPER GLIDERS 290
- XXV. A SELF-LAUNCHING MODEL AEROPLANE 296
- XXVI. APPARATUS FOR SIMPLE SCIENTIFIC  
EXPERIMENTS 311
- XXVII. A RAIN GAUGE 327
- XXVIII. WIND VANES WITH DIALS 334
- XXIX. A STRENGTH-TESTING MACHINE 345
- XXX. LUNG-TESTING APPARATUS 353
- XXXI. HOME-MADE HARMONOGRAPHS 364
- XXXII. A SELF-SUPPLYING MATCHBOX 389
- XXXIII. A WOODEN WORKBOX 394
- XXXIV. WRESTLING PUPPETS 398
- XXXV. DOUBLE BELLOWS 402
- XXXVI. A HOME-MADE PANTOGRAPH 405
- XXXVII. A SILHOUETTE DRAWING MACHINE 410
- XXXVIII. A SIGNALLING LAMP 415
- XXXIX. A MINIATURE GASWORKS 421

**I.****A SAWING TRESTLE**

A strong and stable sawing trestle is one of the most important accessories of the carpenter's shop, whether amateur or professional. The saw is constantly being used, and for it to do its work accurately the material must be properly supported, so that it cannot sway or shift.

Anybody who has been in the habit of using a wobbly chair or box to saw on will be surprised to find how much more easily wood can be cut when resting on a trestle like that illustrated by Figs. 1 to 3.

The top, *a*, of the trestle is 29 inches long, 4 inches - wide, and 2 inches thick. At one end it has a deep nick, to serve much the same purpose as the notched board used in fretworking; also to hold on edge such

things as doors while their edges are planed up. Pushed back against the wall the trestle is then "as good as a boy."

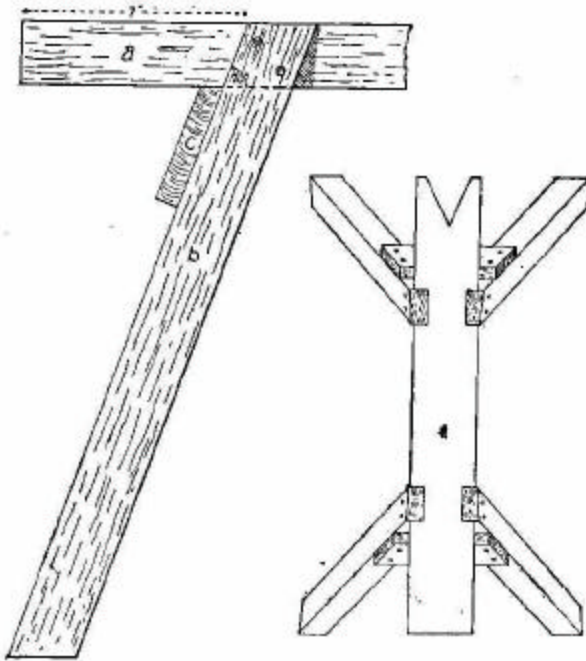

FIG. 1.—Leg of sawing trestle (left). Trestle seen from above (right).

Fig I.--Leg of sawing trestle (left). Trestle seen from above (right).

The four legs are made of 2 by 2 inch stuff. To start with, the pieces should be 24 inches long, to allow for the waste of cutting on the angle.

**Cutting the Notches.** -- Make four marks 7 inches from the four corners of the top, set your bevel to an angle of 70 degrees (or cut an angle out of a card with the help of a protractor), and lay a leg against each mark in turn, the end projecting an inch or so above the top. Move the leg about till it makes the proper angle at the mark, and draw a pencil line down each side of the leg as close up as possible. Since the legs may vary slightly in size, use each once only for marking, and number it and the place to which it belongs.

Lines must now be drawn along the upper and under sides of the top, parallel to and  $\frac{3}{4}$ -inch from the edge, to complete the marking out of the notches.

Cut just inside the side marks with a fine tenon saw, and remove the wood between the cuts back to the top and bottom marks with a broad, sharp chisel, making the surface of the cut as true and flat as you can. Then "offer" the leg that belongs to the cut, its end projecting an inch or so. If it won't enter, bevel off the sides of the cut very slightly till it will. A good driving fit is what one should aim at. While the leg is in place, draw your pencil in the angles which it makes with the top above and below, to obtain the lines AB, CD (Fig. 2, *a*).

**Bevelling the Legs.**—The marking out of the bevells will be much expedited if a template is cut out of tin or card. It should be just as wide as the legs, and at a point 4 inches from one end run off at an angle of 162 degrees from one edge. (See Fig. 2, *b*.)

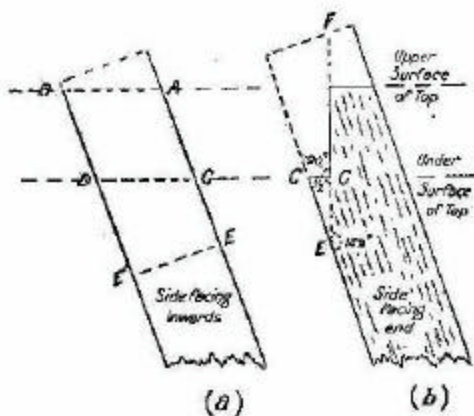

FIG. 2.—Showing how to cut sloping joint for trestle leg.

FIG. 2.—Showing how to cut sloping joint for trestle leg.

Draw with a square a line, EEI, across what is to be the inside of the leg. The template is applied to the end side of the leg and moved up till its sloping edge occupies a position in which a perpendicular dropped on to it from C is 1/2 inch long. Mark the line EF (Fig. 2, *b*) and the perpendicular CG. The bevel is marked on the other side of the leg, the angle of the template being at E1 (Fig. 2, *a*) to guide the saw, which is passed down through the leg just outside the marks till in line with CD. The piece is detached by a cross cut along CG, CD.

This procedure, which sounds very complicated, but is really very simple, and performed much more

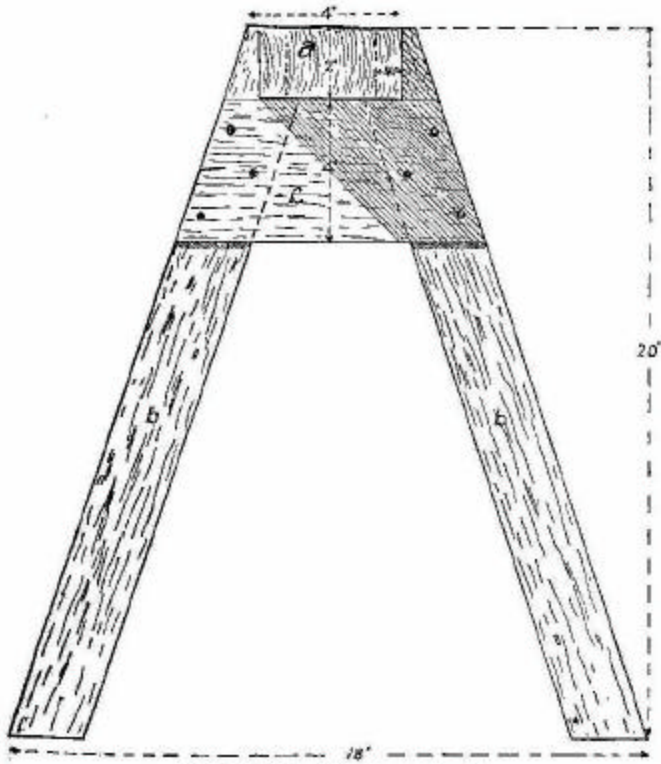

FIG. 3.—End elevation of sawing trestle.

Fig.3 -- End elevation of sawing trestle.

quickly than it can be described, yields a leg properly bevelled and provided with a shoulder to take the weight of the top.

The leg at the diagonally opposite corner is an exact replica of the one first made; the other two are

similar, but the direction of the bevels is reversed, as will be evident after a little consideration.

When all the legs are ready, knock them into place, driving the shoulders tight up against the top, and nail them on. The projections are sawn off roughly and planed down flush with the top. Then affix the tie C at each end, and plane its edges off neatly.

**Truing the Legs.** -- Stand the stool on end, top flat against the wall. Measure off a 20-inch perpendicular from the wall to the outside corner of each of the two upper legs. (Fig. 3.) Lay a straight-edge from mark to mark, and draw lines across the legs. Reverse the trestle, and do the same with the legs at the other end. Then turn the trestle on its side, and draw lines on the other outside faces of the legs, using the lines already made as guides. If the operation has been carried through accurately, all eight lines will be in a plane parallel to the top. Cut off the ends of the legs below the lines, and the trestle is finished.

**II.****A JOINER'S BENCH.**

AFTER finishing his sawing trestle the reader may be willing to undertake a larger job, the manufacture of a joiner's bench--if he does not already possess a good article--heavy and rigid enough to stand firm under plane and hammer.

For the general design and detailed measurements he is referred to Figs. 4 and 5, in which the dimensions of each part are figured clearly. The length of 5 feet, width of 2 feet (exclusive of the back E), and height of 2 feet 7-1/2 inches will be found a good average. If the legs prove a bit long for some readers, it is a simple matter to lay a plank beside the bench to raise the (human) feet an inch or two.

In order to give rigidity, the struts S1S2 of the trestles at the end and the braces DD on the front are "halved" where they overlap the legs and front



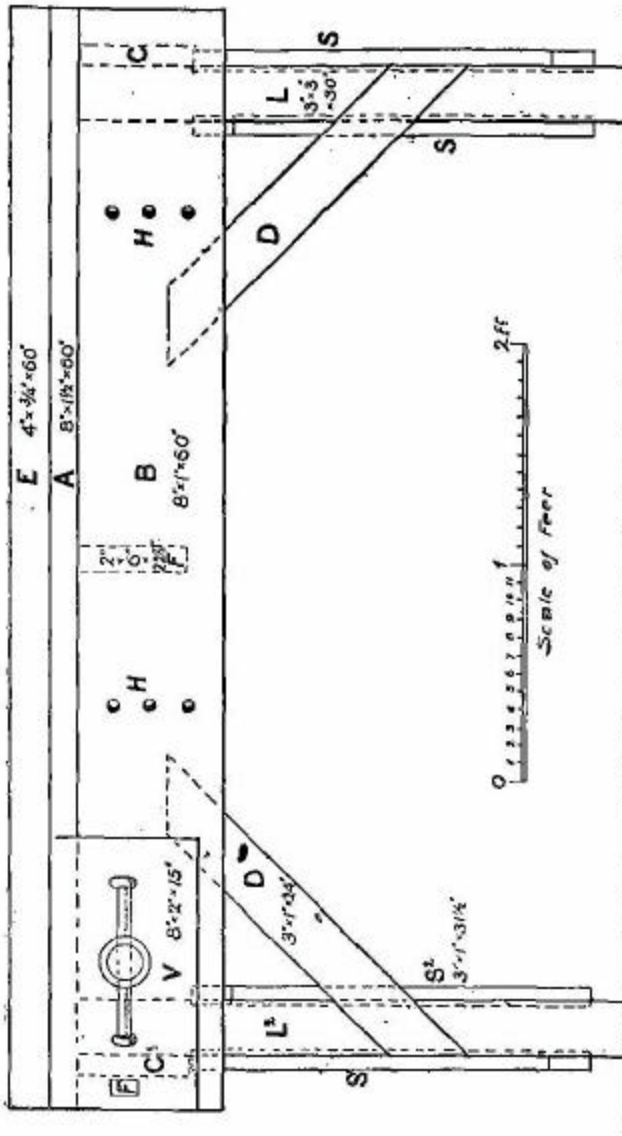

FIG. 4. — Front elevation of joiner's bench.

Fig. 4. -- Front elevation of Joiner's bench.

so as to offer the resistance of a "shoulder" to any thrust.

**Materials.**-The cost of these will be, approximately: wood, 12s. 6d.; [12 Shillings. 6 Pence] bench screw, 1s. 6d.; nails and screws, 1s.; or 15s. in all. It is advisable to show the timber merchant the specifications, so that he may cut up the stuff most economically.

If the wood is mill-planed before delivery a lot of trouble will be saved, as no further finish will be required, except perhaps at the top corners. In passing, one should remark that the boards used should be of the widths and lengths given; while as regards thickness the figures must be taken as nominal, as in practice the saw cut is included. Thus a 1-inch board would, when planed, be only  $\frac{7}{8}$  to  $\frac{15}{16}$  inch thick, unless the actual size is specified, in which case something extra might be charged.

### **Construction.**

**The Trestles.**-- These should be made first. Begin by getting all the legs of exactly the same length, and square top and bottom. Then cut off two 22-inch lengths of the 6 by 1 inch wood, squaring the ends carefully. Two of the legs are laid on the floor, one end against the wall or a batten nailed to the floor and

arranged parallel to one another, as gauged by the piece C, which is nailed on perfectly square to both, and with its top edge exactly flush with the ends of the legs.

Next take the 3 by 1 inch wood for the struts, and cut off a piece 32 inches long. Two inches from one end of it make a cross mark with the square, and from the ends of the mark run lines towards the end at an angle of 45 degrees. Cut along these lines, and lay one of the edges just cut up against C, and flush with the outer edge of L1 (Fig. 5). Tack the strut on temporarily to both legs, turn the trestle over, and draw your pencil (which should have a sharp point) along the angles which the strut makes with the legs. This gives you the limits of the overlaps. Detach the strut.

The marking-gauge now comes into use. Set it at  $\frac{3}{8}$  inch, and make marks on the sides of the strut down to the limits, pressing the guide against what will be the inner face of the board. The ends must now be divided down along the gauge scratches to the limit mark with a tenon or panel saw, the saw being kept on the inside of the mark, so that its cut is included in the  $\frac{3}{8}$  inch, and a cross cut made to detach the piece and leave a shoulder. The strut is

(1,650)

"offered" again to the legs, and a mark is drawn across the bottom parallel to the ends or the legs for the final saw cut. Nail on the strut, pressing the legs

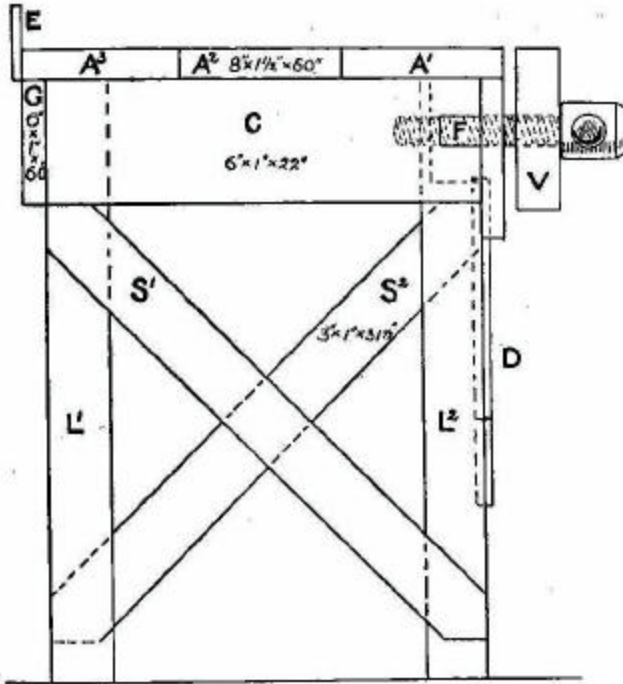

FIG. 5.—End elevation of joiner's bench.

FIG. 5. -- End elevation of joiner's bench.

well up against the shoulders. Its fellow on the other side of the legs is prepared in exactly the same manner; and the second trestle is a duplicate of the

first, with the exception that the directions of the struts are reversed relatively to the C piece, to preserve the symmetry--which, however, is not an important point.

**Back and Front.** -- The only operation to be performed on the front piece B and the back G is the notching of them both on the inside faces at the centre to take the ends of the bearer F, which performs the important function of preventing any bending of the top planks. Lay the boards together, top edges and ends level, and mark them at the same time. The square is then used on the faces to give the limits for the notches, which should be 1/4 inch deep and chiselled out carefully.

Draw cross lines with your square 3 inches from each end of both pieces, on the inside, to show where the legs are to be. Bore holes in the boards for the 3-inch screws which will hold them to the legs.

**Attaching the Trestles.** -- Stand the trestles on their heads and lay the back and front up to them, using the guide marks just drawn. A nail driven part way in through one of the screw holes, and a batten tacked diagonally on the DD lines, will hold a leg in position while the screws are inserted. (Make sure

that the tops of the legs and the top edges of B and G are in the same plane.)

**Affixing the Braces.** -- The braces DD, of 3 by 1 inch stuff, can now be marked off and cut exactly down the middle to the limits of the overlap. Screw on the braces.

The bearer F is next cut out. Its length should be such as to maintain the exact parallelism of B with G, and the ends be as square as you can cut them. Fix it in position by two 2-inch screws at each end.

The bench is now ready for covering. Begin with the front board, A1. Bore countersunk holes for 3-inch screws over the centre of the legs and half an inch from the front edge, 1 foot apart. Arrange A1 with its front edge perfectly flush with the face of B, and tack it in place by nails driven through a couple of screw holes, and insert all the screws. The middle board, A2, is laid up against it, and the back board, A3 (bored for screws like the front board), against that. Screw down A3.

You must now measure carefully to establish lines over the centres of CC and F. Attach each board to each of these by a couple of screws. All screws in the top of the bench are countersunk

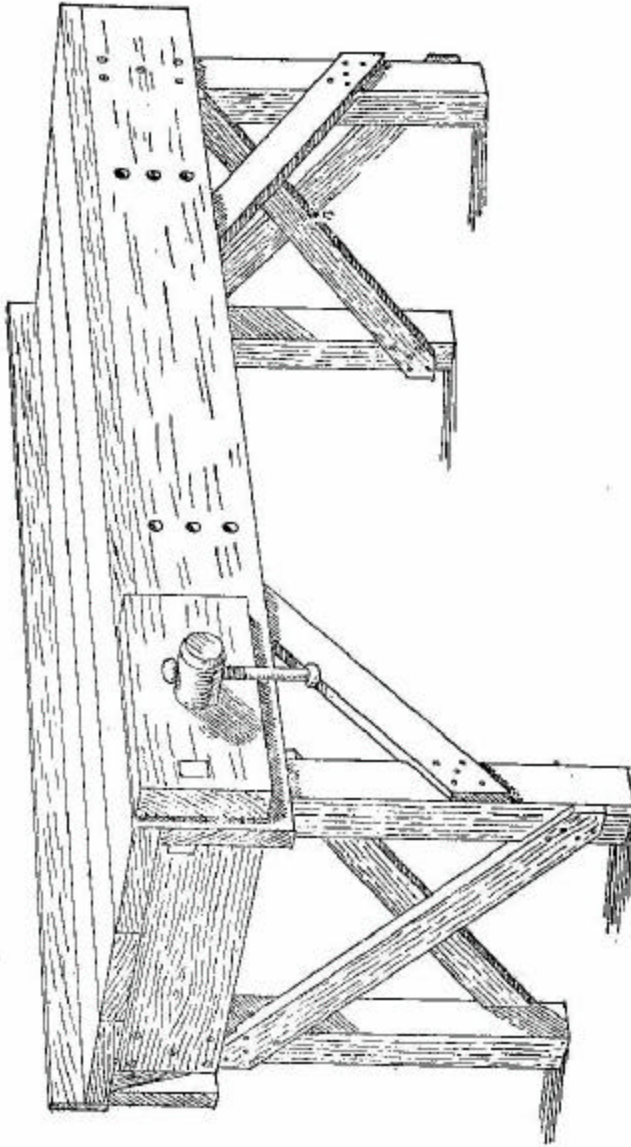

FIG. 6.—Perspective view of joiner's bench.

Fig. 6. -- Perspective view of joiner's bench.

1/8 inch below the surface. Screw the ledge E, of 4 by 5/8 inch wood, on to the back of G, with 2-1/2 inches projecting. This will prevent tools, etc., slipping off the bench.

**The Vice.** -- This important accessory consists of an 8 by 2 by 15 inch piece, V, a 2-inch diameter wooden bench screw and threaded block, and a guide, F. (*Note.* -- A 1-1/8-inch diameter wrought iron screw is very preferable to the wooden, but its cost is about 4s. more.) V should be tacked to B while the 2-inch hole for the bench screw is bored through both with a centre bit, at a point 8 inches from the guide end on the centre line of V. This hole must be made quite squarely to enable the screw to work freely. If a 2-inch bit is not available, mark out a 2-inch ring and bore a number of small holes, which can afterwards be joined by a pad-saw; and finish, the hole thus formed with a half-round rasp. The threaded block for the screw is attached to the inner side of H in the angle formed by the leg and the board A1. The guide F is then fitted. This is pinned in to V, and the slides through B. If a rectangular piece is used, cut the hole in V first; then screw V up tightly, and mark B through V. It may be found more convenient to use a circular piece, in which case the holes



for it can be centre-bitted through V and B in one operation. If after fitting V projects above A, plane it down level.

The finishing touches are rounding off all corners which might catch and fray the clothes, and boring the 3/4-inch holes, HH, for pegs on which planks can be rested for edge planing.

For a "stop" to prevent boards slipping when being planed on the flat, one may use an ordinary 2-inch wood screw, the projection of which must of course be less than the thickness of the board planed. Many carpenters employ this very simple expedient; others, again, prefer a square piece of wood sliding stiffly through a hole in A1 and provided on top with a fragment of old saw blade having its teeth projecting beyond the side facing the work. The bench is countersunk to allow the teeth to be driven down out of the way when a "clear bench" is required.

Just a word of warning in conclusion. Don't be tempted to *naïl* the parts together -- with the exception of the trestle components -- to save trouble. The use of screws entails very little extra bother, and gives you a bench which can be taken to pieces very quickly for transport, and is therefore more valuable than a nailed one.

### **III. A HANDY BOOKSTAND.**

A bookstand of the kind shown in Fig. 7 has two great advantages: first, it holds the books in such a position that their titles are read more easily than when the books stand vertically; second, it can be taken to pieces for packing in a few moments, as it consists of but four pieces held together by eight removable wedges. We recommend it for use on the study table.

Oak or walnut should preferably be chosen as material, or, if the maker wishes to economize, American whitewood or yellow pine. Stuff  $\frac{1}{4}$  inch (actual) thick will serve throughout if the stronger woods are used;  $\frac{3}{8}$  inch for the shelf parts in the case of whitewood or pine.

The ends (Fig. 8) are sawn out of pieces 5-1/2 by 10 inches, and nicely rounded off on all but the bottom edge, which is planed flat and true. The

positions for the holes through which the shelf eyes will project must be marked accurately, to prevent the stand showing a twist when put together. The simplest method of getting the marks right is to cut a template out of thin card and apply it to the two ends in turn, using the base of each as the adjusting

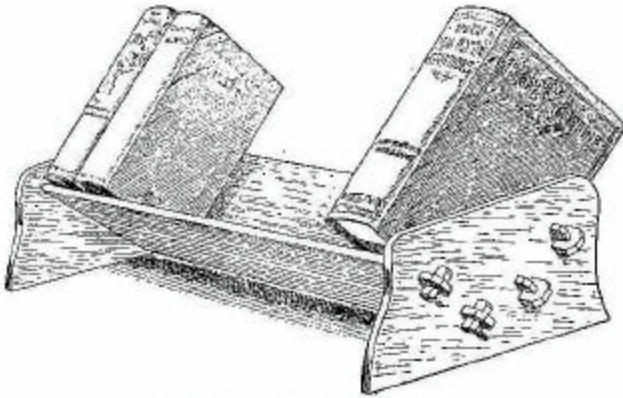

FIG. 7.—Perspective view of bookstand.

Fig. 7. -- Perspective view of bookstand.

line. Fret-saw the holes, cutting just inside the lines to allow for truing up with a coarse file.

The shelves *a* and *b* are 15 inches long, exclusive of the lugs *c, c, c, c*, and 4-1/2 and 4-3/4 inches wide respectively. As will be seen from Fig. 8, *b* overlaps *a*. Both have their top edges rounded off to prevent injury to book bindings, but their bottom edges are left square.

As the neatness of the stand will depend largely on *a* and *b* fitting closely against the sides, their ends should be cut out and trued carefully, special attention being paid to keeping the shoulders between and outside the lugs in a straight line. The wedge holes in *c*, *c*, *c*, *c* measure  $\frac{1}{2}$  by  $\frac{1}{4}$  inch, and are arranged to be partly covered by the sides, so that the wedges cannot touch their inner ends. (See Fig. 9.) This ensures the shelves being tightly drawn up against the sides when the wedges are driven home.

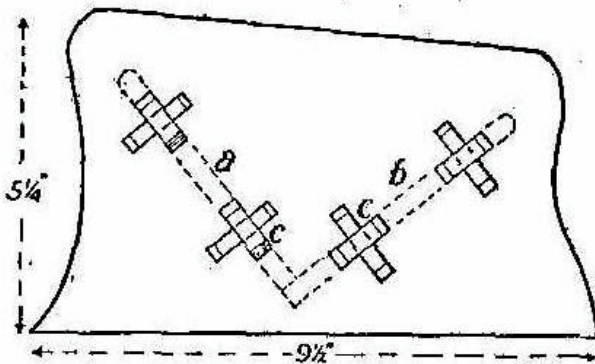

**FIG. 8.—End elevation of bookstand.**

Fig. 8. -- End elevation of bookstand.

The wedges should be cut on a very slight taper of not more than half an inch in the foot run, in order to keep their grip. Prepare a strip as thick as the smaller dimension of the holes,  $\frac{3}{8}$  inch wide at one end, and  $\frac{7}{8}$  inch wide at the other. Assemble the parts and push the piece through a hole until it gets a good hold, mark it across half an inch above the hole, and cut it off. Then plane the strip down parallel to the edge that follows the grain until the

end will project half an inch beyond the lug next fitted. Mark and cut off as before, and repeat the process until the eight wedges are ready in the rough. Then bevel off the outside corners and smooth them -- as well as the rest of the woodwork -- with fine glass paper.

Shelves and sides should be wax-polished or given a coat or two of varnish.

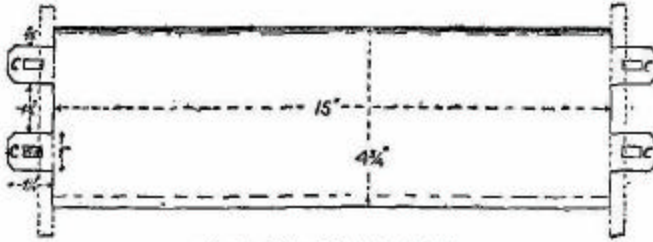

FIG. 9.—Plan of bookstand shelf.

Fig. 9. Plan of bookstand shelf.

Don't drive the wedges in too tight, or you may have to lament a split lug.

If the stand is to be used for very heavy books, or the shelves are much longer than specified here, it is advisable to bring the angle of the shelves down to the bottom of the standards, to relieve the shelves of bending strain at the centre; or to use stouter material; or to unite the shelves at two or three points by thin brass screws inserted through holes *drilled* in the overlapping part.

#### IV. A HOUSE LADDER.

The preparation and putting together of the parts of a ladder having round, tapered rungs let into holes in the two sides is beyond the capacity of the average young amateur; but little skill is needed to manufacture a very fairly efficient substitute for the professionally-built article -- to wit, a ladder of the kind to which builders apply the somewhat disparaging adjective "duck."

The rungs of such a "duck" ladder are merely nailed to the outside if the ladder is required for temporary purposes only; but as we are of course aiming at the construction of a thing made to last, we shall go to the trouble of "notching-in" each rung (see Fig. 10), so that the sides shall take the weight directly, and the nails only have to keep the rungs firmly in position. The objection to notching-in is that it reduces the strength of the ladder, which

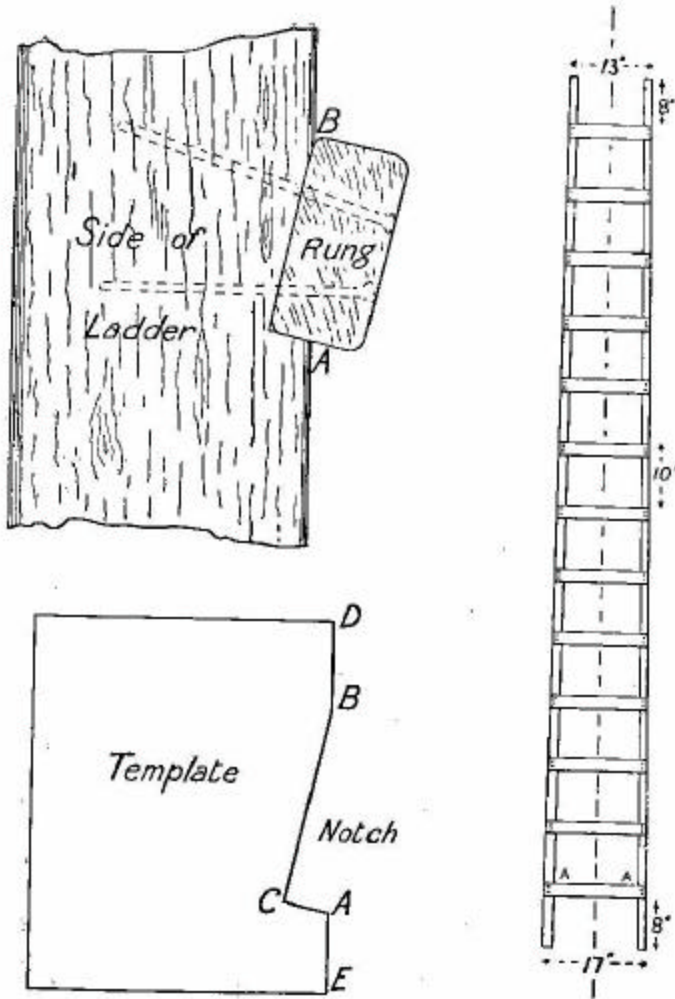

FIG. 10.—House ladder and details of letting in a rung.

Fig. 10 -- House ladder and details of letting in a rung.

is of course only that of the wood between the bottom of the notches and the plain side. Therefore it is necessary to have sides somewhat deeper than would be required for a centrally-runged ladder; which is pierced where the wood is subjected to little tension or compression.

**Materials.** -- The length of the ladder will decide what the stoutness of the sides should be. For a ladder about 12 feet long, such as we propose to describe, larch battens 3 by 1-1/8 inches (actual) in section and free from knots, especially at the edges, will be sufficiently strong to carry all reasonable weights without danger of collapse. But be sure to get the best wood obtainable. The rungs may be of 2 by 1 inch stuff, though 2 by 3/4 inch will suffice for the upper half-dozen, which have less wear, and are shorter than those below.

The rungs are 10 inches apart (Fig. 10), centre to centre. The distance may be increased to a foot, Or even more if weight-saving is an object.

### CONSTRUCTION.

**Preparing the Sides.** -- These are cut to exactly the same length, which we will assume to be 11 feet 6 inches, planed quite smooth and rounded off slightly



at the corners to make handling comfortable. Before marking them for the rungs it is important that they shall be so arranged that both incline equally towards a centre line.

Stretch a string tightly three inches above the ground, and lay the sides of the ladder on edge to right and left of it, their ends level. Adjust the bottom ends 8-1/2, the top ends 6-1/2 inches from the string, measuring from the outside. Tack on cross pieces to prevent shifting, and then, starting from the bottom, make a mark every 10 inches on the outside corners, to show the position of the tops of the rungs. A piece of the wood to be used for making the rungs of is laid up to the pairs of marks in turn, and lines are drawn on both sides of it.

**Cutting the Notches.** -- The work of marking the ends of the notches will be quickened, and rendered more accurate, if a template (Fig. 10) is cut out of tin. The side AC is 3/8 to 1/2 inch deep. Apply the template to both faces of the side in turn, with its corner A at the line below the rung, and DE flush with the upper corner. When all the notches have been marked cut down the AC line of each with a tenon saw, and chisel along BC till the wedge-shaped chip is removed. Finish off every notch as neatly as

possible, so that the rungs may make close contact and keep water out.

**Preparing the Rungs.** -- Lay a piece of rung batten across the lowest notches, the end overhanging the side by a quarter of an inch or so to allow for the taper of the ladder, and draw your pencil along the angles which it makes with the sides. Mark the positions of the nail holes. Cut off the rung at the cross lines; drill the four nail holes on the skew, as shown in Fig. 10; and round off all the corners. The other rungs are treated in the same manner, and the sides are then separated, for the inside top corner and both back corners, which will be handled most, to be well rounded off and rubbed smooth with glass paper.

**Assembling.** -- Before putting the parts together give them a coating of paint, as the contact surfaces will not be accessible to the brush afterwards. When the paint has dried, lay the sides out as before, and nail on the rungs with 3-inch nails. To counteract any tendency of the sides to draw apart, a light cross bar should be fixed on the back of the ladder behind the top and bottom rungs.

Round off the end angles of the rungs, and apply a second coating of paint.

*Note.* -- A ladder of this kind is given a more presentable appearance if the rungs are let in square to the sides and flush, but at the sacrifice either of strength or lightness, unless narrow rungs of a hard wood, such as oak, be used. Moreover, square notches are not so easy to cut out as triangular.

For a short ladder, not more than 9 feet long, the section of the sides may safely be reduced to 2-3/4 by 1 inch (actual), if good material is selected.

**V.  
A DEVELOPING SINK.**

Many amateur photographers are obliged to do their developing in odd corners and under conditions which render the hobby somewhat irksome if a large number of plates have to be treated. The main difficulty is to secure an adequate water supply and to dispose of the waste water. At a small expenditure of money and energy it is easy, however, to rig up a contrivance which, if it does not afford the conveniences of a properly equipped dark room, is in advance of the jug-and-basin arrangement with which one might otherwise have to be content. A strong point in favour of the subject of this chapter is that it can be moved without any trouble if the photographer has to change his quarters.

The foundation, so to speak, of the developing sink is a common wooden washstand of the kind which has

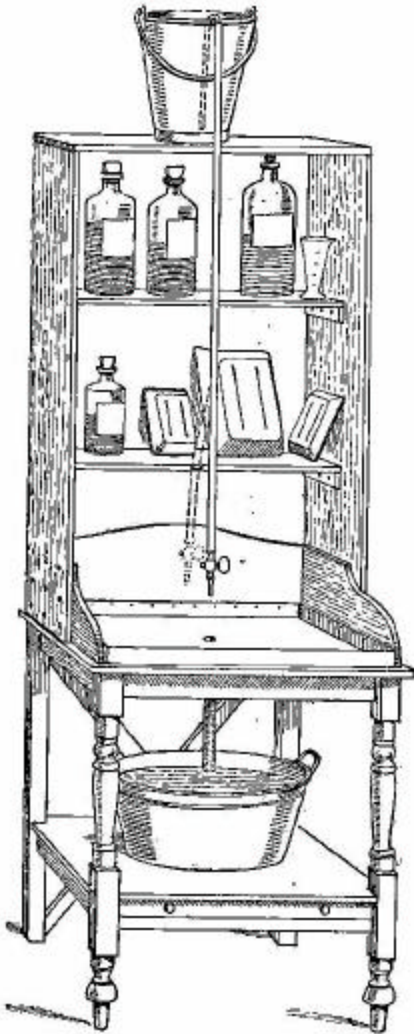

FIG. 11.—A home-made developing sink for the dark room.

a circular hole in the top to hold the basin. A secondhand article of this sort can be purchased for a shilling or two. A thoroughly sound specimen should be selected, even if it is not the cheapest offered, especial attention being paid to its general rigidity and the good condition of the boards surrounding the basin shelf.

The area of the top is generally about 20 by 15 inches;

Fig. 11. -- A home-made developing sink for the darkroom.

but if a stand of larger dimensions can be found, choose it by preference.

The general design of the sink and its equipment is shown in Fig. 11. For the uprights, which rest on the beading of the washstand, use two boards 9 inches wide, 1/2 inch (actual) thick, and 36 inches long. The top shelf, to carry the pail or other water container, should be of 1-inch stuff; and the two lower shelves be not more than 5 inches wide and 3/4 inch thick. Space the shelves at least 11 inches apart, so that they may accommodate tall bottles. The superstructure will gain in rigidity if the intermediate shelves are screwed to the uprights, in addition to being supported on ledges as indicated; and if the back is boarded over for at least half its height, there will be no danger of sideways collapse, when a full bucket is put in position.

The top of the washstand, on which the developing will be done, must be provided with a tray of lead or zinc. Lead is preferable, as lying flatter; but the jointing at the corners is more difficult than the soldering of sheet zinc, which, though more liable to chemical corrosion, is much lighter than the thinnest lead--weighing about 1-1/2 lbs. to the square foot--that could well be used. If lead is selected, the

services of a plumber had better be secured, if the reader has had no experience in "wiping a joint."

A zinc tray is prepared by cutting out of a single sheet a piece of the shape shown in Fig. 12. The dimensions between the bending lines (dotted) are  $1/8$  inch less in both directions than those of the shelf.

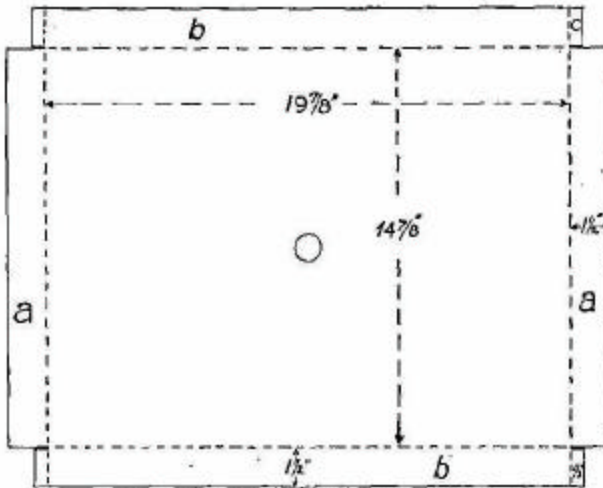

FIG. 12.—Showing how the tray for sink is marked out.

FIG. 12. -- Showing how the tray for sink is marked out.

The turn-ups *a*, *a*, *b*, *b*, should not be less than 1-1/2 inches wide. Allow half an inch at each end of *b b* for the turnover *c*. Turn *a a* up first, then *b b*, and finally bend *c c* round the back of *a a*, to which they are soldered. A drop of solder will be needed in each corner to make it water-tight. When turning up a

side use a piece of square-cornered metal or wood as mould, and make the angles as clean as possible, especially near the joints.

A drain hole, an inch or so in diameter, is cut in the centre of the tray. To prevent the hands being injured by the tray, the front should be covered by a 1/2-inch strip of zinc doubled lengthwise, or be made a bit deeper than 1-1/2 inches in the first instance and turned over on itself.

Before the tray is put in position the basin hole must be filled in, except for an opening to take the waste pipe. The plug is pad-sawed out of wood of the same thickness as the top, to which it is attached by crossbars on the under side. The whole of the woodwork, or at least those parts which are most likely to get wetted, should then be given a coat or two of paint.

A waste pipe, somewhat larger than the drain hole and 3 inches long, having been firmly soldered to the tray, beat the edges of the hole down into the pipe. Then prepare a wooden collar to fit the pipe outside, and drill a hole on the centre line to take a carpenter's screw. If the edges of the tray are supported on slats 3/16 to 1/4 inch thick, and its centre is kept in contact with the wood by the collar pressing



against the underside of the shelf, any water will naturally gravitate to the centre and escape by the waste pipe. This automatic clearance of "slops" is a very desirable feature of a developing sink.

To prevent water splashing on to the sides of the stand and working down between tray and wood, tack pieces of American cloth on the sides with their edges overlapping the tray edges by an inch or so.

A small two-handled bath is the most convenient receptacle for the waste water. It should hold at least a quarter as much again as the water tank, so as to avoid any danger of overflowing. A piece of old cycle tyre tubing, tied to the waste pipe and long enough to reach below the edge of the bath, will prevent splashing--which, when chemicals are being poured away, might prove disastrous to light-coloured clothes.

The supply pipe has a siphon-piece of "compo" tubing at the top, to draw off the water when the tube has been filled by suction, and a small tap at the bottom. This tap, when not in use, should be held back out of the way by a wire hook attached to the lowest of the upper shelves. A piece of linoleum should be cut to fit the bath-shelf and protect the drawer below.

**VI.**  
**A POULTRY HOUSE AND RUN.**

This chapter should be of interest to the keeper of poultry on a small scale, for even if the instructions given are not followed out quite as they stand, they may suggest modifications to suit the taste and means of the reader.

The principle of the combined run and house--which will accommodate a dozen fowls without overcrowding, especially if it be moved from time to time on to fresh ground--will be understood from Figs. 13 and 14. The first of these shows the framework to which the boards for the house and the wire for the run are nailed. Its over-all length of 10 feet is subdivided into five "bays" or panels, 2 feet long (nearly) between centres of rafters. Two bays are devoted to the house, three to the run.

The materials used comprise:--

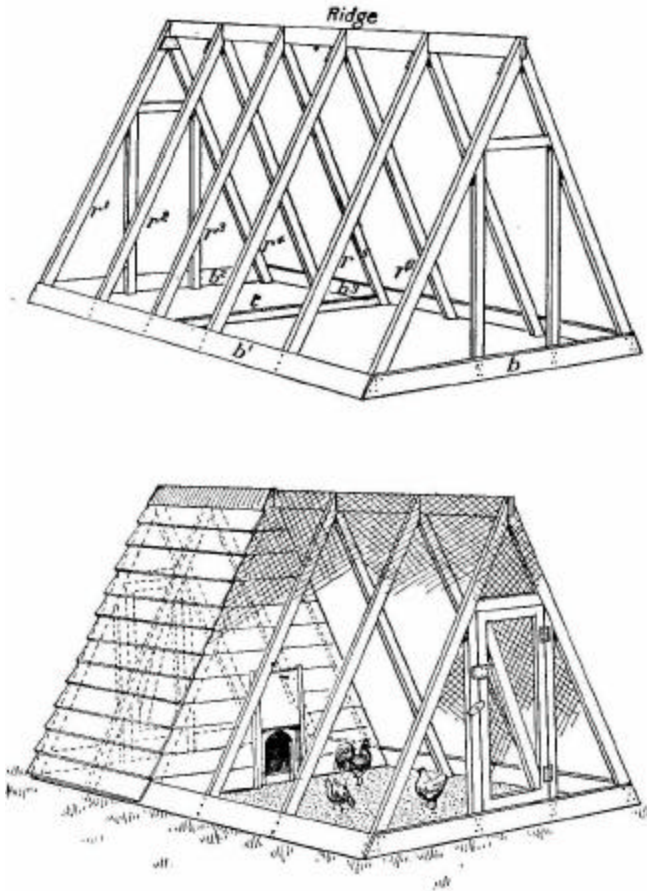

FIG. 13.—Frame for poultry house and run (above).  
Completed house and run (below).

Fig. 13.--Frame for poultry house and run (above).  
Completed house and run (below).

One square (10 by 10 feet) of weather boarding  
6 inches wide, for covering in the house.

44 feet of 4 by 1, for base and ridge.

56 feet of 3 by 1, for eight rafters.

28 feet of 3 by 1-1/2, for four rafters.

50 feet of 2 by 1-1/2, for door frames and doors.

6 feet of 2 by 2, for tie *t*.

45 feet of 2-foot wire netting.

Two pairs of hinges; two locks; staples, etc.

The total cost as estimated from prices current at the time of writing is 25s. This cost could be considerably reduced by using lighter stuff all through for the framework and doors and by covering in the house with old boards, which may be picked up cheaply if one is lucky. Whether it is advisable to sacrifice durability and rigidity to cost must be left to the maker to decide. Anyhow, if the specifications given are followed, an outfit warranted to last for several years will be produced.

**A Few Points.** -- The vertical height of the run is just under 6 feet, the tips being cut away from the rafters at the apex. The width at the ground is exactly 6 feet. The base angles made by AA with B (Fig. 14) are 63 degrees; that which they make with one another, 54 degrees. The rafters *r1* and *r3* at each end of

the house are half an inch thicker than the rest, as they have to stand a lot of nailing.

### CONSTRUCTION.

**Cutting the Rafters.** -- If floor space is available, chalk out accurately the external outline of a pair of rafters (80 inches long each before shaping) and a line joining their lower ends. Then draw a line bisecting the ridge angle. With this template as guide the rafters can be quickly cut to shape. Another method is to cut one rafter out very carefully, making a notch for half the width of the ridge, and to use it as a pattern for the rest. In any case the chalked lines will prove useful in the next operation of pairing the rafters and uniting them by a tie just under the ridge notch. Cut a 4 by 1 inch notch at the bottom of each rafter, on the outside, for the base piece. The two end pairs have the B pieces (Fig. 14) nailed on to them, and *r3* the tie *t*, which should be in line with the rafters. The other three pairs require temporary ties halfway up to prevent straddling during erection.

**Door Frames and Doors.** -- The method of fixing the frame of the door at the run end is shown in Fig. 14. The material for the frame being 1/2 inch thicker than

that of the rafters, there is room for shoulders at the top angles, as indicated by dotted lines. The door frame at the house end is of the same thickness as *r1* so that no overlapping is possible. This being the case, screws should be used in preference to nails,

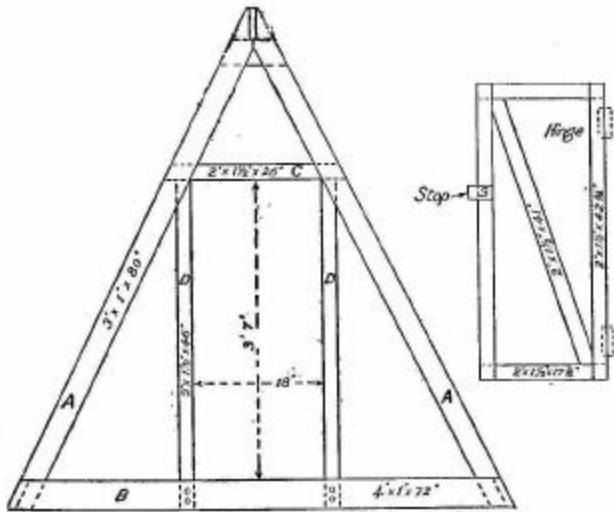

FIG. 14.—On left, elevation of end of run; on right, door for run.

Fig. 14. -- On left, elevation of end of run; on right, door for run.

which are liable to draw a sloping face out of position as they get home.

The *doors* are made of 2 by 2 inch stuff, halved at the corners. Cut out the top and bottom of the two sides; lay them on the floor so as to form a perfect

rectangle, and nail them together. The strut is then prepared, care being taken to get a good fit, as any shortness of strut will sooner or later mean sagging of the door. Cut the angles as squarely as possible, to ensure the strut being of the same length both inside and out.

*Note.* -- As the door is rectangular, it does not matter which corners are occupied by the ends of the strut; but when the door is *hung*, the strut must run relatively to the side on which the hinges are, as shown in Fig. 14.

Amateurs--even some professionals--have been known to get the strut the wrong way up, and so render it practically useless.

**Covering the Ends of the House.** -- The ends of the house should be covered before erection, while it is still possible to do the nailing on the flat. The run end is boarded right over, beginning at the bottom, and allowing each board to overlap that below it by 1 inch. The board ends are flush with the outer sides of the rafters. When boarding is finished, cut (with a pad saw) a semicircular-topped run hole, 14 inches high and 8 inches wide, in the middle of the bottom. Any structural weakness caused by severing the two lowest boards is counteracted by the two grooved pieces in which the drop-door moves.

Odds and ends of weather boards should be kept for the door end of the house, which requires short pieces only, and is not boarded below the top of *b2*. The door may be weather-boarded to match the rest of the end, or covered by a few strakes of match-boarding put on vertically.

The two base pieces, *b1* and *b2*, and the ridge should be marked off for the rafters at the same time. All three are 10-foot lengths of 4 by 1 wood, unless you prefer the ridge to project a bit, in which case you must allow accordingly.

Stand all three pieces together on edge, and make the marks with a square across the tops. Allow a distance of 4 feet between the outside faces of *r1* and *r3*; halve this distance to get the centre of *r2*; and subdivide the distance between *r3* and *r6* so that each rafter is separated from its neighbours by an equal space, which will be 1 foot 11 inches. Number the marks and continue them down the sides of the boards with the square. There should be a mark on *each side* of the place to be occupied by the intermediate rafters, to prevent mistakes; for it is obvious that if a rafter is fixed on the left side of a single ridge mark and on the right of the corresponding mark on the base, the result will not be pleasing.



**Erection.** -- The services of a second pair of hands are needed here, to hold while nailing is done. Nail holes having been drilled in the tops of the rafters and in the base pieces, the ends are stood upright and tacked to the ridge at the places marked for them, and after them the intermediate rafters, working from one end to the other. Then tack on the base pieces, *b1*, *b3*. Get the ends quite perpendicular, and nail a temporary cross strut or two on the outside of the rafters to prevent shifting while the final nailing up is done.

**Covering the Shed** -- Sixteen boards, 4 feet 2 inches long, are needed for each side, as, owing to the overlap of one inch, each tier covers only five of the 80 inches. The ridge is made watertight by a strip of sheet zinc, a foot wide, bent over the top and nailed along each edge.

**Waterproofing.** -- All the woodwork should now be given a coating of well-boiled tar, paint, creosote, or some other preservative, worked well down into the cracks. Creosote and stoprot are most convenient to use, as they dry quickly.

**Netting.** -- When the preservative has dried, fix on the netting with 3/4-inch wire staples. Begin at the base on one side, strain the netting over the ridge,

and down to the base on the other side. Be careful not to draw the rafters out of line sideways. The last edge stapled should be that on the roof of the house.

*Note.* -- When driving nails or staples into a rafter or other part, get a helper to hold up some object considerably heavier than the hammer on the farther side to deaden the blow. Lack of such support may cause damage, besides making the work much more tedious and difficult.

**Finishing off.** -- The doors are now hung, and fitted with buttons and padlocks. The *stops* should be on the doors, not on the frames, where they would prove an obstruction in a somewhat narrow opening. *Perches* should be of 2 by 1 inch wood, rounded off at the top, and supported in *sockets* at each end so as to be removable for cleaning; and be all *on the same level*, to avoid fighting for the "upper seats" among the fowls. A loose floor, made in two pieces for convenience of moving, will help to keep the fowls warm and make cleaning easier, but will add a few shillings to the cost. The inside of the house should be well *whitewashed* before fowls are admitted. To prevent draughts the triangular spaces between the roof boards and rafters should be plugged, but *ample*

*ventilation* must be provided for by holes bored in the ends of the house at several elevations, the lowest 2 feet above the base. *Handles* for lifting may be screwed to the faces of *b* and *b*<sup>2</sup> halfway between the door frame and the corners.

**VII.**  
**A SHED FOR YOUR BICYCLE.**

The problem, how to house one or more cycles, often gives trouble to the occupiers of small premises. The hall-way, which in many cases has to serve as stable, is sadly obstructed by the handles of a machine; and if one is kept there, the reason generally is that no other storage is available.

If accommodation is needed permanently for two or three cycles belonging to the house, and occasionally for the machine of a visitor, and if room is obtainable in a backyard or garden in direct communication with the road, the question of constructing a really durable and practical cycle shed is well worth consideration. I say constructing, because, in the first place, a bought shed costing the same money would probably not be of such good quality as a home-made one; and secondly, because the actual construction,

(1,650) 4

while not offering any serious difficulty, will afford a useful lesson in carpentry.

Cycle sheds are of many kinds, but owing to the limitations of space it is necessary to confine attention to one particular design, which specifies a shed

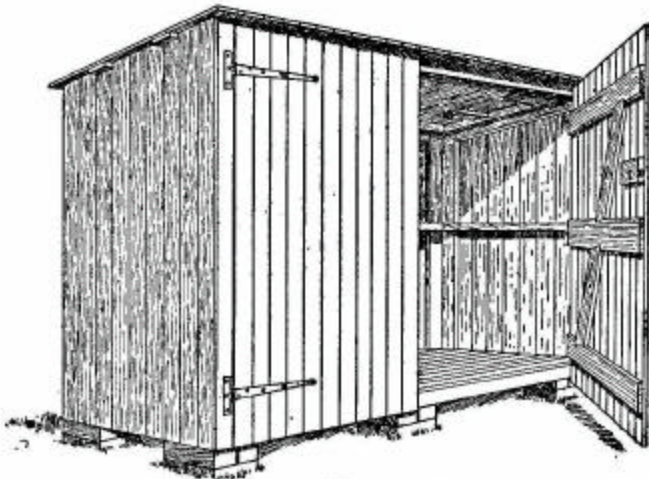

FIG. 15.—Cycle shed completed.

FIG. 16. -- Cycle shed completed.

composed of sections quickly put together or taken apart--portability being an important feature of "tenants' fixtures"--and enables fullest advantage to be taken of the storage room. As will be seen from the scale drawings illustrating this chapter, the doors extend right across the front, and when they

are open the whole of the interior is easily accessible. The fact that the cycles can be put in sideways is a great convenience, as the standing of the machines head to tail alternately economizes room considerably.

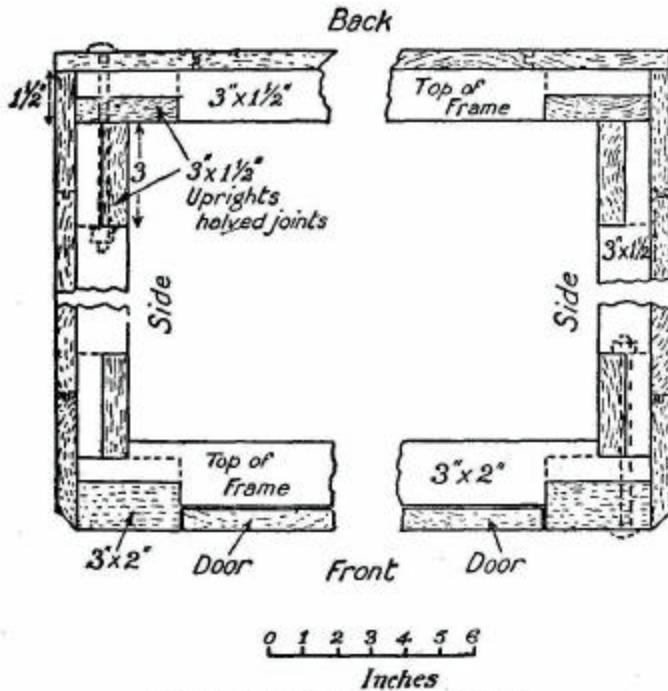

FIG. 16.—Plan of corner joints of cycle shed.

FIG. 16. -- Plan of corner joints of cycle shed.

I ought to mention before going further that the shed to be described is very similar, as regards design and dimensions, to one in a back issue of

*Cycling.* By the courtesy of the proprietors of the journal I have been permitted to adapt the description there given.[1]

**Dimensions and General Arrangements.** -- The shed is 8 feet long over all, 5 feet 6 inches high in front, 5 feet high at the back, 3 feet deep over all, under the roof, which projects 3 inches fore and aft, and 2 inches at each end. It consists of seven parts: two sides, roof, back, front frame and doors, and a bottom in two sections.

The reader should examine the diagrams (Figs. 16 to 24) to get a clear understanding of the disposal of the parts at the corners. Fig. 16 makes it plain that the frames of the back and front overlap the frames of the sides, to which they are bolted; and that the covering of the back overlaps the covering of the sides, which in turn overlaps the front frame.

All corner joints are halved. In order to allow the doors to lie flush with the front of the doorframe uprights, the last must project the thickness of the door boards beyond the frame longitudinally; and to bring the front uprights of the sides up against the uprights of the door frame, the longitudinals

[Footnote 1: By Mr. Hubert Burgess. ]

are notched, as shown (Fig. 16), to the depth of the set-back for the doors.

**Materials.** -- The question of cost and the question of materials cannot be separated. A shed even of the dimensions given consumes a lot of wood, and the last, that it may withstand our variable and treacherous climate for a good number of years, should, as regards those parts directly exposed to the weather, be of good quality. Yellow deal may be selected for the boards; pitch pine is better, but it costs considerably more. For the frames and non-exposed parts generally ordinary white deal will suffice.

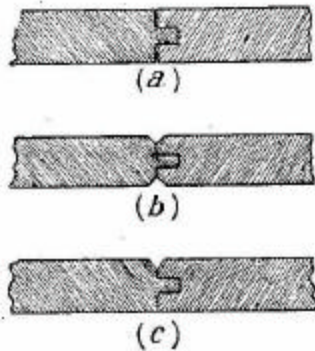

FIG. 17.—Types of match boarding: (a) square joint; (b) double-V; (c) single-V.

FIG. 17.—Types of match boarding: (a) square joint; (b) double-V; (c) single-V.

The scale drawings are based on the assumption that matching of one of the forms shown in Fig. 17, and measuring 4 inches (actual) across, exclusive of the tongue, and  $\frac{5}{8}$  inch (actual) thick, is used.

As advised in the case of the carpenter's bench, (p. 15) the prospective constructor should let the wood merchant have the specifications, so that he may provide the material in the most economical lengths. The following is a rough estimate of the



wood required, allowing a sufficient margin for waste:-

4-1/2 (over tongue) by 5/8 inch (actual) yellow match boarding  
for sides, roof, back, and doors:

1-1/2 squares = 150 sq. feet. = 450 feet run.

White 4-1/2 by 3/4 inch square-shouldered flooring:

1/4 square = 25 sq. feet. = 75 feet run.

3 by 1-1/2 inch battens = 88 feet run.

4 by 1-1/2 inch battens = 26 feet run.

3 by 2 inch battens = 27 feet run.

5 by 1-1/2 inch battens = 8 feet run.

2 by 1-1/2 inch battens = 21 feet run.

There will also be required :-

Twelve 6-inch bolts and nuts.

Two pairs 18-inch cross-garnet hinges.

Two door bolts.

One lock (a good one).

Four yards of roofing felt.

Two gallons of stoprot.

Three lbs. wire-nails

A few dozen 3-inch and 1-1/2-inch screws.

The total cost of the materials will come to about 2 pounds, 2s.

**CONSTRUCTION.**

The scale drawings are so complete as to dimensions that, assuming the materials to be of the sizes specified, they may be followed implicitly. It is, of course, easy to modify the design to suit any slight differences in dimensions; and to avoid mistakes all the stuff should be gauged carefully beforehand.

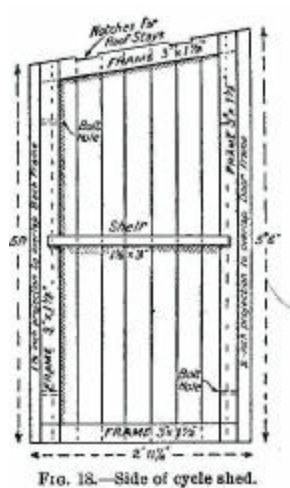
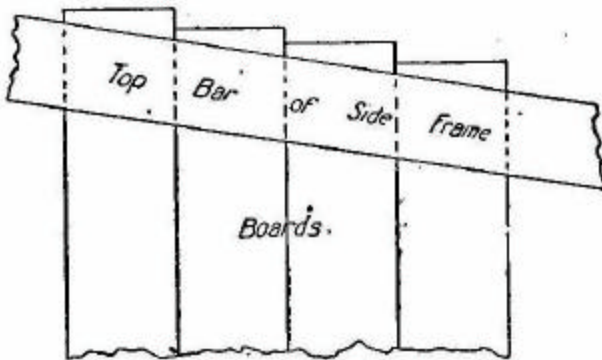

FIG. 18.—Side of cycle shed.

**The Sides.** -- When laying out the frames for these it is necessary to bear in mind that the front upright is somewhat less than 5 feet 6 inches long, and the back upright rather more than 5 feet, owing to the slope of the roof, and to the fact that they are set in 2 inches from the back and front. To get the lengths and angle of the half-joints right, lay the verticals, which should be 5 feet 6 inches and 5 feet 1 inch long before trimming, on the floor, at right angles to the bottom of the frame (2 feet 7-3/4 inches

long) and quite parallel to one another. (We will assume the half-joints to have been made at the bottom.) The batten for the top is laid across the ends of the verticals, its top edge in line with a 5-foot 6-inch mark at a point 2 inches beyond the front vertical, and with a 5-foot mark 2 inches beyond the back vertical, the distances being measured perpendicularly from the bottom of the frames produced. The lines for the joints can then be marked, and the joints cut. The notches for the roof stays should not be cut till the roof is being fitted.



**FIG. 19—Boards at top of side, fixed ready for cutting off.**

FIG. 19- Boards at top of side, fixed ready for cutting off.

Use the side frame first made as template for the other.

The shelves are notched at the ends, so that their back faces shall be flush with the board side of the frame.

Fix the corners with the screws, and plane off the projecting angles of the uprights.

When putting on the boards, start at the back of

the frame. Plane down the groove edge of the first board until the groove is out of the board, and apply the board with 1-1/2 inches projecting beyond the frame. Leave a little spare at each end of every board, and when the side is covered run a tenon-saw across both ends of all the boards close to the

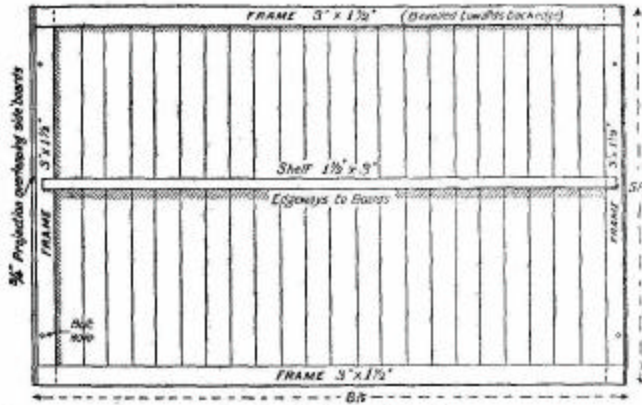

FIG. 20.—Back of cycle shed.

FIG. 20.—Back of cycle shed.

frame, and finish up with the plane. This is quicker and makes a neater job than cutting each board to size separately.

**The Back** (Fig. 20). --When laying out the *frame* for this, remember that there is a bevel to be allowed for along the top, and that the height of the frame at the *front* must be that of the back of a side

frame. (See Fig. 21.) The boards should be cut off to the same slope.

Twenty-four boards should exactly cover the back.

Cut the tongue neatly off that last fixed, and glue it into the groove of the first board.

**The Front.** -- The *frame* requires careful making. For details of corner joints see Fig. 16. The 3-inch faces of the top and bottom bars are vertical. The upper side of the top bar is planed off to the angle of the slope. (Fig. 23.)

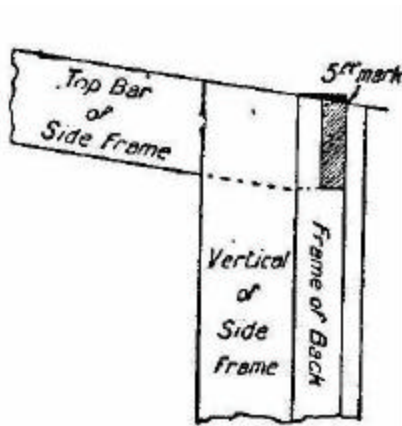

**FIG. 21.**

FIG. 21.

**The Doors** (Fig. 22). -- These are the most difficult parts to construct, as the braces which prevent the front edges dropping must be carefully fitted in order to do their work properly.

The eleven outside boards of each door are held together by two 4-inch ledges 6 inches away from the ends, and one 5-inch central ledge. Allow a little "spare" on the boards for truing up. Boards and ledges having been nailed together, lay a piece of 4 by 1-1/2 inch batten across the ledges on the line which the braces will take, and mark the ledges accordingly. Next mark on the batten the ends of the braces. These project half an inch into the

ledges, and terminate on the thrust side in a nose an inch long, square to the edge of the brace. The obtuse angle is flush with the edge of the ledge. Cut out the braces, lay them in position on the ledges, and scratch round the ends. Chisel out the notches very carefully, working just inside the lines to ensure

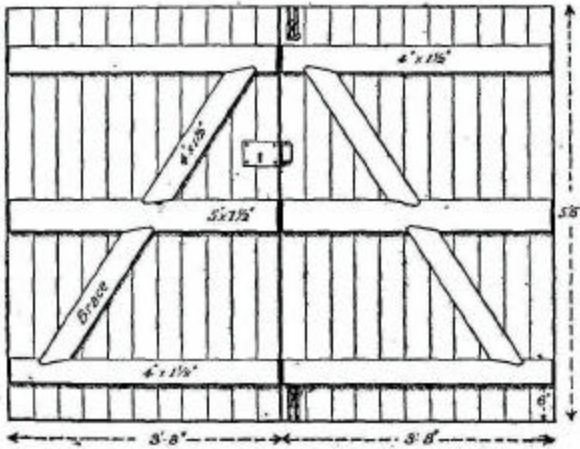

FIG. 22.—Doors of shed.

FIG. 22.—Doors of shed.

the brace making a tight fit. If there is any slackness at either end, the brace obviously cannot carry the weight of the door until the door has settled slightly, which is just what should be prevented. Therefore it is worth while taking extra trouble over this part of the work.

*Cautions.* --Don't get the nose of the brace too near the end of the ledge. Nail the boards on specially securely to the ledges near the ends of the braces.

**Fitting the Doors.** -- The doors should now be laid on the top of the frame and secured to it by the four hinges. The long ends of these are held by screws driven through the boards into the bearers; the cross pieces are screwed to the uprights of the door frame. The doors when closed should make a good but not tight fit with one another.

### **PUTTING THE PARTS TOGETHER.**

The two sides, front, and back are now assembled, on a level surface, for drilling the holes for the bolts which hold them together. The positions of the bolts will be gathered from the drawings. Get the parts quite square before drilling, and run the holes through as parallel to the sides as possible. If the bolts are a bit too long, pack washers between nut and wood until the nut exerts proper pressure.

*Caution.* - The hole must not be large enough to allow the square part just under the head to revolve, for in such a case it would be impossible to screw

up the nut. Its size ought to be such as to require the head to be *driven* up against the wood.

**The Roof.** -- The boards of this are attached to a frame which fits closely inside the tops of the sides, back, and front. To get the fit of the frame correct, it must be made a bit too wide in the first instance, and then be bevelled off at the

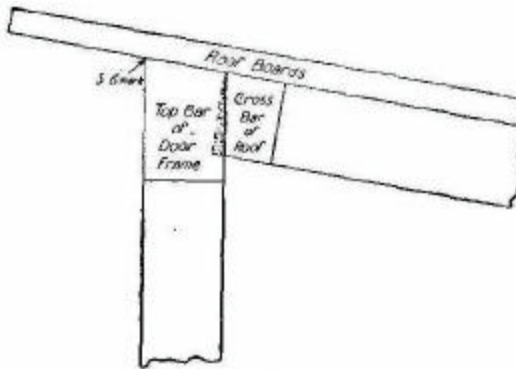

FIG. 23.

Fig. 23

front, as shown in Fig. 23, and the reverse way at the back. The ends are notched for the stays AA, and the frame then tacked firmly, by driving nails into the sides, etc., below it, in the position which it will occupy when the roof is on, except that it projects upwards a little. Cut off twenty-five boards 3 feet 7 inches long. Omitting the end ones for the present, lay the remainder up to one another in order, their ends an equal distance from the frame, and nail to the frame. Lift off the roof, insert and secure AAAA, and nail on the end boards. Then rule parallel straight lines 3 feet 6 inches apart across all the boards from end to end of the roof, and cut along



these lines. The roof is replaced after notches have been cut in the tops of the sides to take AAAA, and secured to the vertical parts by six bolts, the positions of which are shown in Fig. 24.

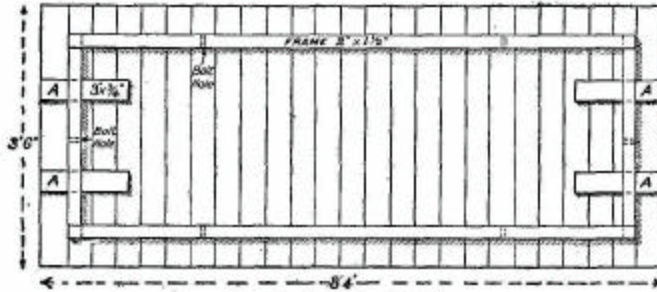

FIG. 24.--Top of cycle shed.



FIG. 25.--Floor of shed.

FIG. 24. -- Top of cycle shed.

FIG. 25. -- Floor of shed.

**The Floor** (Fig. 25). -- The making of this is so simple a matter that one need only point out the need for notching the end boards to allow the floor to touch the sides and back, and the doors when

closed. It should be screwed to the frames, on which it rests, in a few places.

**Preserving the Wood** --All outside wood is dressed with stoprot or creosote, rubbed well into the joints of the boarding.

**Felting the Roof.** -- The felt is cut into 4-foot lengths, and each length has its ends turned over and nailed to the underside of the roof. The strips must overlap an inch or two. When the felt is on, dress it with boiled tar, and sprinkle sand over it while the tar is still liquid.

**Fitting.** -- The two bolts to hold one door top and bottom and the lock are now fitted, and a couple of hooks screwed into the door frame clear of the door, to sling a machine from while it is being cleaned or adjusted.

**Mounting the Shed.** -- The shed must be raised a few inches above the ground, on bricks or other suitable supports. Don't stand it close to a wall. Air should be able to circulate freely under and all round it.

#### **CUTTING DOWN EXPENSE.**

If the cost appears prohibitive, it may be reduced somewhat (1) by using thinner boards; (2) by reducing

the height of the shed by 1 foot. A very cheap shed, but of course not comparable in quality with the one described, can be made by using odd rough boards for the outside, and covering them with roofing felt well tarred.

**VII.**

**A TARGET APPARATUS FOR RIFLE SHOOTING.**

The base is a 1-inch board, 18 inches long and 7 inches wide.

The target-holder is a piece of wood 1-1/2 inches square, and a couple of inches longer than the side of the largest target to be used. To one face nail a piece of strip lead as weight; and to the parallel face attach, by means of brads driven in near one edge, a piece of thin wood of the same size as the face. The free long edge of this should be chamfered off slightly on the inside to enable the target to be slipped easily between it and the roller.

The roller is pivoted on two short spindles--which can be made out of stout wire nails--driven into the ends near the face farthest from the weight. (See Fig. 26.)

For standards use a couple of the small angle irons

used for supporting shelves, and sold at about a penny each. These are screwed on to the board 2 inches from what may be considered to be the rear edge, and are so spaced as to leave room for a washer on each spindle between the roller and the standards, to diminish friction.

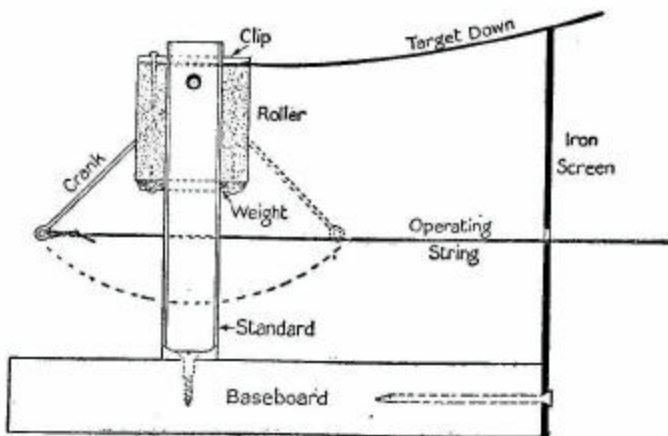

FIG. 26.—Side elevation of disappearing target apparatus.

FIG. 26.-Side elevation of disappearing target apparatus.

Remove one standard, and drive into the roller a piece of stout wire with its end bent to form an eye. The inclination of the arm to the roller is shown in Fig. 26.

To the front of the board now nail a rectangle of stout sheet iron, long and deep enough to just protect

the standards and roller. Place the roller in position, insert a target, and revolve the roller to bring the target vertical. A small wire stop should now be fixed into the baseboard to prevent the arm coming farther forward, and a hole for the operating string be drilled in the protection plate at the elevation of the eye on the arm. The edges of this hole need careful smoothing off to prevent fraying of the string. A small eyelet or brass ring soldered into or round the hole will ensure immunity from chafing.

Drive a couple of long wire nails into the front edge of the board outside the iron screen to wind the string on when the target is put away.

It may prove a convenience if plain marks are made on the string at the distances from which shooting will be done.

The above description covers apparatus for working two or more targets simultaneously on a long roller, or separately on separate rollers mounted on a common baseboard.

If it is desired to combine with the apparatus a "stop" for the bullets, the latter (a sheet of stout iron of the requisite strength) may be affixed to the rear of the baseboard, and furnished with a handle at the top to facilitate transport.

## **IX. CABINET-MAKING.**

### **A Match-box Cabinet.**

This is useful for the storage of small articles, such as stamps, pens, seeds, needles, and a number of other minor things which easily go astray if put in a drawer with larger objects.

The best boxes for the purpose are those used for the larger Bryant and May matches. Select only those boxes of which the tray moves easily in the case.

The cases should be stood on end on some flat surface while being glued together. A box or drawer with truly square corners is useful for assembling them in; if they are packed into one corner they cannot slew about. Press the boxes together while the glue is setting.

Now glue the back ends of the cases (from which the trays should have been removed), and press them

against a piece of thin card. When the glue is dry, apply some more with a small brush to the back angles inside the covers, to ensure a good hold on

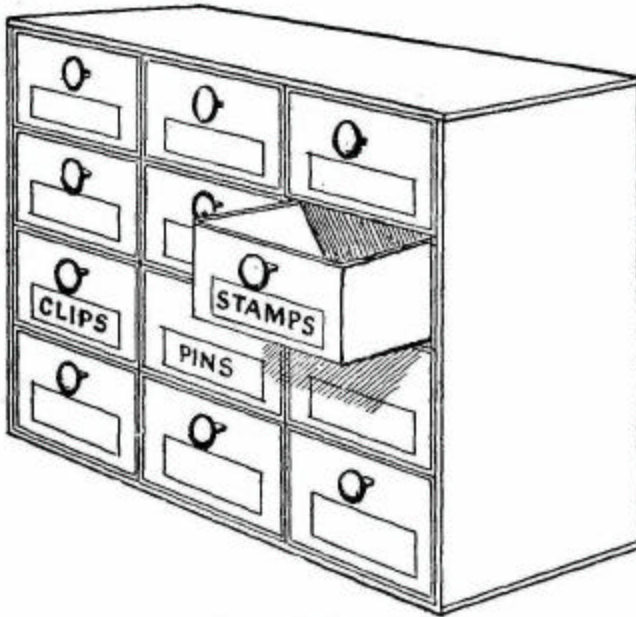

FIG. 27.—Match-box cabinet.

FIG. 27. -- Match-box cabinet.

the backing. Trim off the card to the outline of the pile.

Select for the front end of the drawer that for which the wood is doubled over. Paste outside the end a piece of white paper, whereon words and



numbers will be more plainly visible. The life of the trays will be increased if the insides are neatly lined with thin paper.

For "handles" use boot buttons, or loops of thin brass wire, or brass paper clips. To give the cabinet a neat appearance you should cover it outside with paper of some neutral tint; and if you wish it to be stable and not upset when a rather sticky drawer is pulled out, glue it down to a solid wooden base of the proper size.

### **A Cardboard Cabinet.**

We now proceed to a more ambitious undertaking -- the manufacture of a cabinet for the storage of note-paper, envelopes, labels, etc. The only materials needed are some cardboard and glue; the tools, a ruler and a very sharp knife. For the marking out a drawing board and T-square are invaluable. The cardboard should be fairly stout, not less than 1/16 inch thick.

Begin with the drawers; it is easier to make the case fit the drawers than *vice versa*.

Mark out the drawers as shown in Fig. 28. The areas AA are the front and back; BB the sides. The dotted lines indicate the lines along which the cardboard is bent up. The sides are of exactly the

same length as the bottom, but the front and back are longer than the bottom by twice the thickness of the cardboard, so as to overlap the sides. (The extra length is indicated by the heavy black lines.)

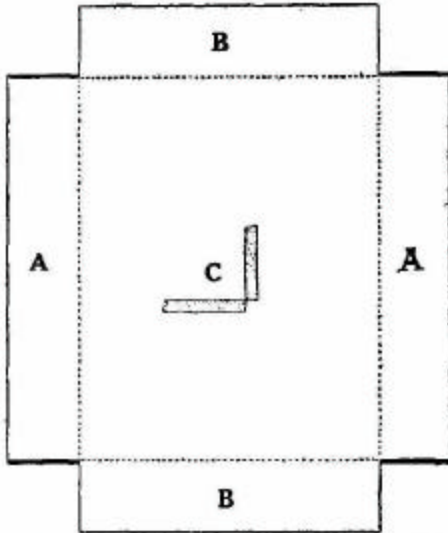

FIG. 28.—Drawer of cardboard cabinet marked ready for cutting.

FIG. 28. -- Drawer of cardboard cabinet marked ready for cutting.

Measure and cut out very carefully to ensure all the drawers being of the same size. Lay a piece of card under the thing cut to avoid blunting the knife or damaging the table. When the blanks are ready, cut them *almost* through along the dotted lines. Use several strokes, and after each stroke test the stubbornness of the bend. When the card is almost severed it will bend up quite easily. *Note.*-- Bend as shown in the inset C; not the other way, or you will snap the card. If you should be so unlucky as to cut the card through in places,

paste a strip of thin paper along the line before turning up.

The four flaps are now bent up, glued together, and covered outside with paper. This part of the business is easy enough if a small square-cornered wooden box be used as a support inside at each angle in turn. It is advisable to glue strips along all the bends both inside and outside. The external strips should be flattened down well, so as to offer no loose edges.

Compare the drawers, and if one is slightly wider than the rest, use it to guide you in making the measurements for the case.

The sides and back of the case are cut out of a single piece. The sides should be a quarter of an inch deeper than the drawers to allow some overlap; the back slightly wider than the drawer.

As each drawer will be separated from that above it by a shelf, allowance must be made for the shelves, and also for a twentieth of an inch or so of "play" to each drawer. To keep on the safe side leave a little extra stuff to be removed later on.

Cut out the bottom to fit inside the back and sides exactly, and a sufficient number of shelves of precisely the same size as the bottom. Attach the bottom to

the sides and back with internal and external strips. When the glue has set, place the guide drawer in position, and lay on it a piece of thin card to cover it over. This card is merely a removable "spacer." Along the side and back edges of the shelf stick projecting strips of stout paper. When the adhesive is dry, turn the strips *round* the end at right angles to the division, glue them outside, and lay the division in position on top of the "spacer."

Place the second drawer and shelf in like manner, and continue till the top of the cabinet is reached. Then mark off and cut away any superfluous card. Glue the top edges, and stand the cabinet head downwards on a piece of cardboard. Trim off the edges of this, and the top is completed, except for binding the corners.

Then attend to the outside back corners of the case, and paste strips in the angles under the shelves. The strips should be forced well into the angles.

For handles use brass rings let sufficiently far through the fronts of the drawers for a wedge of card to be slipped through them and stuck in position. The appearance of the cabinet will be enhanced by a neatly applied covering of paper.

**A Cigar-box Cabinet.**

At the rate of a halfpenny or less apiece one may buy the cigar boxes made to hold twenty-five cigars. These boxes, being fashioned by machinery, are all -- at any rate all those devoted to a particular "brand" -- of the same dimensions; they are neatly constructed, and their wood is well seasoned. Anyone who wishes to make a useful little cabinet may well employ the boxes as drawers in the said cabinet (Fig. 29).

Each box should be prepared as follows:-Remove the lid and paper lining, and rub all the paper binding off the outside angles with a piece of coarse glass paper. This is a safer method than soaking-off, which may cause warping and swelling of the wood. Then plane down the tops of the two sides till they are flush with the back and front, and glue into the corners small pieces of wood of right-angled-triangle section to hold the sides together and the bottom to the sides. To secure the parts further cut a number of large pins down to 3/4 inch, and drive these into the sides through holes carefully drilled in the bottom. Finally, rub the outside of the drawer well with fine glass paper or emery cloth till the surface is smooth all over.

**The Case.** -- If mahogany can be obtained for this, so much the better, as the wood will match the boxes. In default of it, a white wood, stained, will have to serve.

The two sides of the case should be prepared first

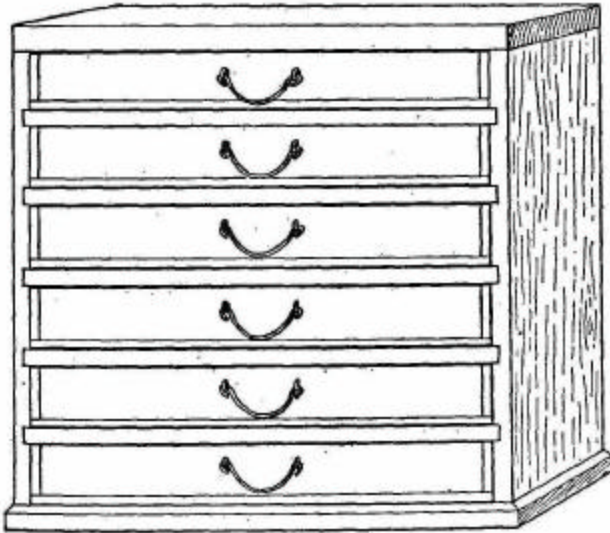

FIG. 29.—Cabinet with cigar-box drawers.

FIG. 29. -- Cabinet with cigar-box drawers.

Wood  $\frac{3}{8}$  inch thick is advised. Each side is 1 inch wider than the depth (outside) of a drawer from front to back. (Whether the drawers shall slide in lengthways or flatways is for the maker to decide.) The length of a side is calculated on the basis that

the drawers will be separated from one another by runners  $1/4$  to  $5/16$  inch deep, and that a slight clearance must be allowed for the drawers to slide in and out freely. In the first instance cut the sides a bit too long. If it be preferred to insert the bottom between the sides, the length must be increased accordingly.

The runners are cut out of the box lids, and planed till their top and bottom edges are parallel. Their length is  $1/4$  inch less than the depth of a drawer. To fill up the spaces between the drawers in front you will need some slips of the same depth as the runners, and  $3/8$  inch longer than the drawer, so that they may be let  $3/16$  inch into the sides of the case at each end.

**Affixing the Runners.** -- This is a very easy matter if a wooden spacer, slightly wider than the depth of the drawer, is prepared. Having decided which is to be the inside face and the forward edge of a side, lay the side flat, and apply the spacer with one edge flush with the bottom of the side, or as far away from it as the thickness of the bottom, as the case may be, and fix it lightly in position with a couple of tacks. The first runner is laid touching the spacer and a little back from the edge to give room for the cross-bar, and fastened by means of short

tacks, for which holes had better be drilled in the runner to prevent splitting. The spacer is now transferred to the other side of the runner, and the second runner is fastened on above it; and so on till all the runners are in position. The square should be used occasionally to make sure that the tops of the runners are parallel to one another. The other side having been treated in like manner, any spare wood at the top is sawn off.

The notches for the front cross-bars between drawers are cut out with a very sharp narrow chisel.

**The Top and Bottom.** -- Make the top of the same thickness as the sides; the bottom of somewhat stouter wood. If the bottom is cut a bit longer than the width of the case, and neatly bevelled off, it will help to smarten the appearance of the cabinet.

When fixing the sides to the bottom and top get the distance correct by placing the top and bottom drawers in position, and insert a piece of thin card between one end of the drawer and the side. This will ensure the necessary clearance being allowed for.

**The Back.** -- Cut this out of thin wood. The top of a sweetstuff box-costing about a halfpenny -- will do well enough. It should be quite rectangular and make a close fit, as it plays the important part of



keeping the case square laterally. Bevel its back edges off a bit. Push it in against the back ends of the runners, and fix it by picture brads driven in behind.

The front bars should now be cut to a good fit and glued in the notches. This completes the construction.

Drop handles for the drawers may be made out of semicircles of brass wire with the ends turned up. The handles are held up to the drawer by loops of finer wire passed through the front and clinched inside.

The finishing of the outside must be left to the maker's taste. Varnishing, or polishing with warmed beeswax, will add to the general appearance, and keep out damp.

The total cost of a ten-drawer cabinet ought not to exceed eighteen pence.

### **A Tool Cabinet.**

The wooden cabinet shown in Fig. 30 is constructed, as regards its case, in the same way as that just described, but the drawers are built up of several pieces. The over-all dimensions of the cabinet represented are as follows: *Height*, including plinth,

25 inches; *width*, 17-3/8 inches; *depth*, 10-1/2 inches. The drawers are 16 inches wide (outside), by 10-1/8 inches

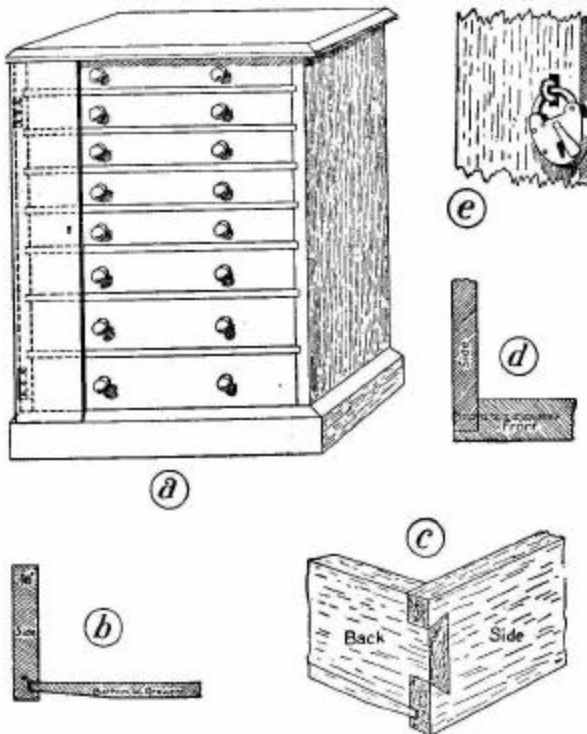

FIG. 30.--Large cabinet (a), details of drawer joints (b, c, d), and padlock fastening (e).

FIG. 30. -- Large cabinet (a), details of drawer joints (b, c, d), and padlock fastening (e).

from back to front, and, reckoning from the bottom upwards, are 3-1/4, 3, 2-1/2, 2, 2, 2, 2, and 1-3/4 inches deep.

The construction of the drawers is indicated by the

diagrams, Fig. 30, *b*, *c*, *d*. The fronts are of 5/8-inch, the sides and backs of 3/8-inch, and the bottoms of (barely) 1/4-inch wood. The grooves should not come nearer than 1/8- inch to the bottom edge, or be more than 5/16 inch wide and deep. The possessor of a suitable "plough" plane will have no difficulty in cutting them out; in the absence of such a tool the cutting gauge and chisel must be used.

The back piece of a drawer has 1/4- inch less height than the front, to allow the bottom to be introduced. The ends or the bottom are bevelled off towards the top edge to fit the grooves, so that no part may be above the grooves.

Glue should be used to attach the sides of a drawer to the back and front in the first place, and nails be added when the glue has set. As an aid to obtaining perfect squareness, without which the drawers will fit badly, it is advisable to mark out on a board a rectangle having the exact inside dimensions of a drawer, and to nail strips of wood up to the lines on the inside. If the parts are put together round this template they will necessarily fit squarely.

**Divisions.** -- If the drawers are to be subdivided in one direction only, the partitions should run preferably from back to front, as this enables the contents of a

compartment to be more easily seen. Where two-direction division is needed the partitions are cut as shown in Fig. 31. All partitions should touch the bottom, and be made immovable by gluing or nailing. It is a mistake to have so many divisions in a drawer that the fingers cannot get into them easily.

Wooden knobs for the drawers can be bought very cheaply of any turner, or suitable brass knobs at any ironmonger's. Take care that the knobs are in line with one another; otherwise the general appearance of the cabinet will suffer.

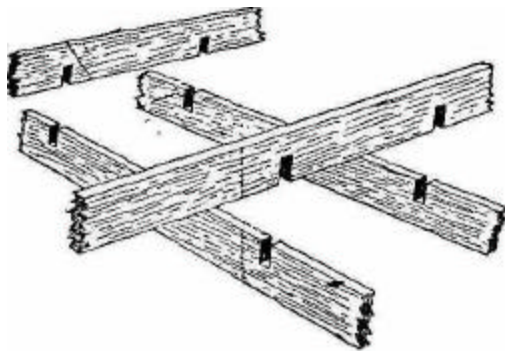

FIG. 31.—Divisions of drawer notched to cross each other.

FIG. 31. -- Divisions of drawer notched to cross each other.

**Lock and Key.** -- If a cabinet is intended for storage of articles of any value it should be provided with lock and key. One lock will secure all the drawers if attached to a flap hinged on one side to the cabinet, as shown in Fig. 30 *a*, to engage a catch projecting from one of the drawers. A special form of lock is sold for the purpose. If the single flap seems to give a lop-sided effect, place a fellow on the other side, and fit it with sunk bolts to shoot into the overhanging

top and plinth. If you wish to avoid the expense and trouble of fitting a lock, substitute a padlock and a staple clinched through the front of a drawer and passing through a slot in the flap (Fig. 30, *e*).

**Alternative Method.** -- The fixing of the front bars can be avoided if the front of each drawer (except the lowest) be made to overhang the bottom by the depth of the runner. This method, of course, makes it impossible to stand a drawer level on a level surface.

**X.**  
**TELEGRAPHIC APPARATUS.**

The easily made but practical apparatus described in this chapter supplies an incentive for learning the Morse telegraphic code, which is used for sending sound signals, and for visible signals transmitted by means of flags, lamps, and heliograph mirrors. Signalling is so interesting, and on occasion can be so useful, that no apology is needed for introducing signalling apparatus into this book.

The apparatus in question is a double-instrument outfit, which enables an operator at either end of the line to cause a "buzzer" or "tapper" to work at the other end when he depresses a key and closes an electric circuit. Each unit consists of three main parts -- (1) the transmitting key; (2) the receiving buzzer or tapper; (3) the electric battery.

The principles of an installation are shown in Fig. 33. One unit only is illustrated, but, as the other is

A	·—	N	—·
B	—...·	O	— — —
C	—·—·	P	·— — ·
D	—··	Q	— — · —
E	·	R	·—·
F	··—·	S	···
G	— — ·	T	—
H	····	U	··—
I	··	V	···—
J	·— — —	W	·— —
K	—·—	X	—·—·
L	·—··	Y	—·— —
M	— —	Z	— — ··

FIG. 32.—Morse alphabet.

Fig. 32. -- Morse alphabet

an exact duplicate, the working of the system will be followed easily.

A wooden lever, L, is pivoted on a support, A. Passing through it at the forward end is a metal bar having at the top a knob, K, which can be grasped conveniently in the fingers; at the other a brass screw, O, which is normally pulled down against the contact, N, by the spiral spring, S. The contact M under K is in connection with the binding post T1 and N with binding post T3; K is joined up to T2, and O to T4.

T3 and T4 are connected with one of the line wires; T1 with the other wire through a battery, B; T3 with the other wire through the buzzer, R. [1]

Assuming both keys to be at rest, as in Fig. 33, the two buzzers are evidently in circuit with the line wires, though no current is passing. If the stem of K is depressed to make contact with M, the electric circuit of which the battery, B, forms part is completed, and the buzzer at the other end of the lines comes into action. Since the depression of K raises O off N, the "home" buzzer's connection with the line wires is broken, to prevent the current being

[Footnote 1: For the buzzer may be substituted the tapper, described on a later page.]



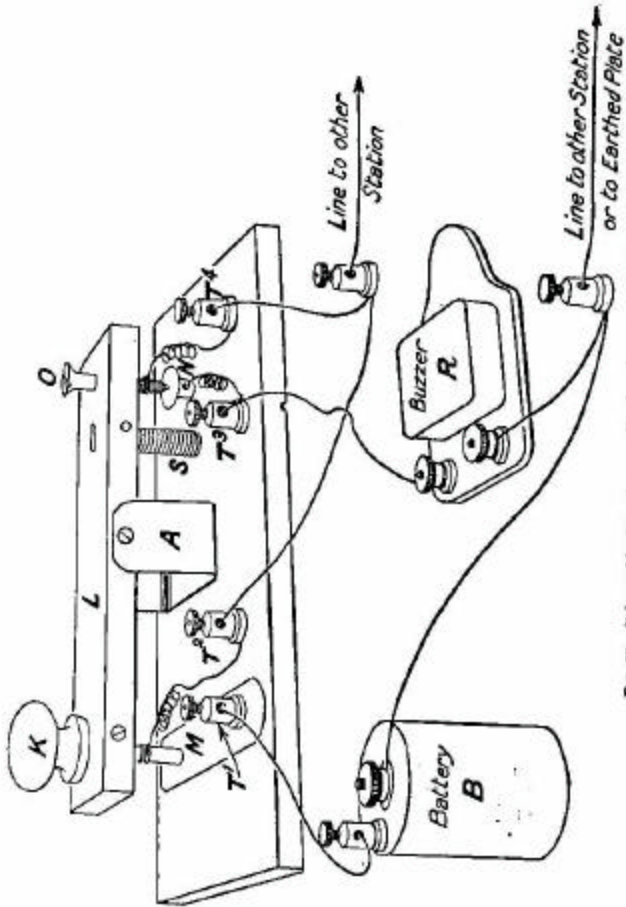

FIG. 33.—Telegraphic apparatus: sending key, buzzer, and battery.

Fig.33 -- Telegraphic apparatus; sending key, buzzer and battery.

short-circuited. The fact that this buzzer is periodically in circuit, even when the key is being worked, makes it possible for the operator at the other end to attract attention by depressing his key, if he cannot read the signals sent.

### **Making the Keys.**

Transmitting keys can be bought cheaply, but not so cheaply as they can be made. The only expense entailed in home manufacture is that of the screw terminals for connecting the keys with the lines and buzzers. These cost only a penny each, and, if strict economy is the order of the day, can be dispensed with should the apparatus not have to be disconnected frequently.

The size of the key is immaterial. The keys made by me have levers 1 inch wide and 5-1/2 inches long, oak being chosen as material, on account of its toughness. K is in each case a small wooden knob on a piece of 3/16-inch brass rod; O a 1-1/2-inch brass screw; A a piece of sheet brass 3-1/2 inches long, marked off carefully, drilled 1/8 inch from the centre of each end for the pivot screws, and in four places for the holding-down screws, and bent up at the ends to form two standards. If you do not possess any brass

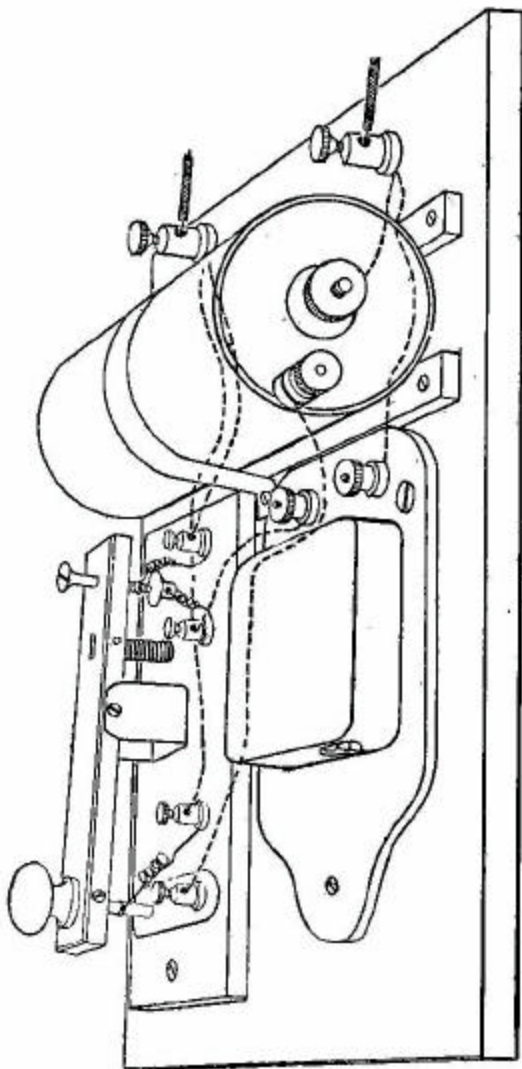

FIG. 84.—Telegraphic apparatus mounted on baseboard.

Fig. 34 -- Telegraphic apparatus mounted on baseboard.

strip, the lever may be supported on wooden uprights glued and screwed to the base.

Contact M is a small piece of brass attached to the base by a screw at one end and by T1 at the other. K was drilled near the end to take the short coil of insulated wire joining it to T2, and O was similarly connected with T4.

The *spring*, S, should be fairly strong. A steel spiral with a loop at each end is most easily fitted. Drill holes in the lever and base large enough for the spring to pass through freely, make a small cross hole through the lever hole for a pin, and cut a slot across the base hole for a pin to hold the bottom of the spring. Adjust the lever by means of screw O so that there is a space of about 1/4- inch between K and M when O and N are in contact, and after the spring has been put in position give the screw a turn or two to bring K down to within 1/16 inch of M. This will put the required tension on the spring.

**The Buzzers.** -- For these I selected a couple of small electric bells, costing 2s. 6d. each. Their normal rate of vibration being much too slow for telegraphic purposes, I cut off the hammers to reduce the inertia, and so adjusted the contact screw that the armature had to move less than one hundredth

of an inch to break the circuit. This gave so high a rate of vibration that the key could not make and break the circuit quickly enough to prevent the buzzer sounding.

### **A Morse Tapper or Sounder.**

In postal telegraph offices a "sounder," and not a "buzzer," is generally used to communicate the signals. Instead of a continuous noise, lasting as long as the key at the transmitting station is held down, the operator at the receiving station hears only a series of taps made by an instrument called a "sounder." The principle of this simple device is illustrated by the working diagrams in Fig. 35. M is a horseshoe magnet fixed to a base, A. Close to it is an armature, AR, of soft iron, attached to a lever, L, which works on a pivot and is held up against a regulating screw, P1, by the pull of the spring SP. When current passes through the magnet the armature is attracted, and the point of the screw S2 strikes against P2; while the breaking of the circuit causes L to fly back against S1. The time intervening between the "down" and "up" clicks tells the operator whether a long or a short -- dash or a dot -- is being signalled.

**Materials.**— A horseshoe magnet and armature taken from an electric bell provide the most essential parts of our home-made instrument in a

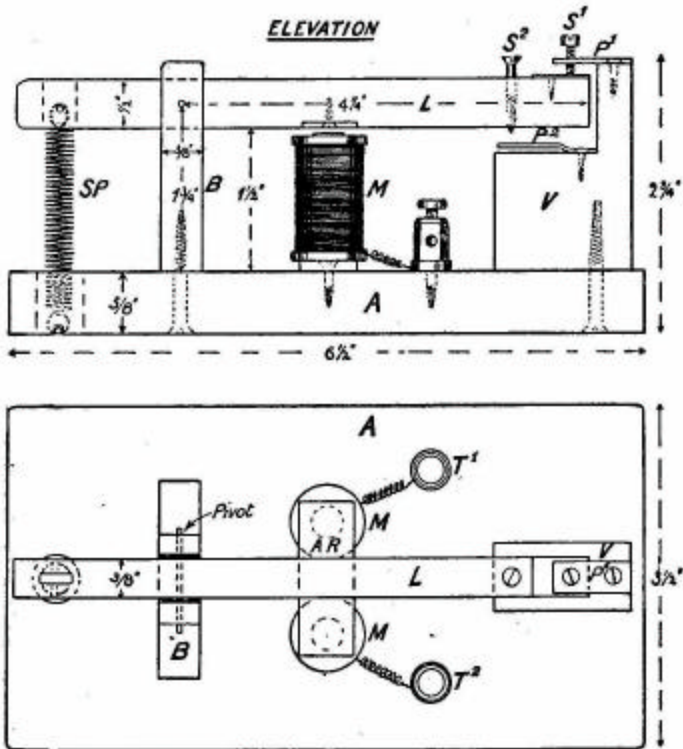

FIG. 35.—Elevation and plan of telegraphic sounder.

FIG. 35.—Elevation and plan of telegraphic sounder.

cheap form. If these are available, expense will be limited to a few pence. Oak or walnut are the best woods to use for the lever, being more resonant than

the softer woods, and for the standard B and stop V. Any common wood is good enough for the base A.

The lever L is 6 inches long, 1/2 inch deep, and 3/8-inch wide, and is pivoted at a point 4-1/4 inches from the stop end. The hole should be bored through it as squarely as possible, so that it may lie centrally without B being out of the square. A piece of metal is screwed to its top face under the adjusting screw S1.

The spring is attached to L and A in the manner already described on p. 89 in connection with the "buzzer."

The plate P2 should be stout enough not to spring under the impact of the lever.

Fig. 36 is an end view of the standard B. The drilling of the pivot hole through this requires care. The screw S2 should be so adjusted as to prevent the armature actually touching the cores of the magnets when attracted. The ends of the magnet winding wire, after being scraped, are clipped tightly against the base by the binding posts T1 T2.

If sounders are used in place of buzzers they are connected up with the keys, batteries, and line wires in the manner shown in Fig. 33.

**Batteries.**

The dry cells used for electric bells are the most convenient batteries to use. They can now be purchased at all prices from a shilling upwards, and give about 1-1/2 volts when in good condition. One cell at each end will suffice for short distances, or for considerable distances if large conductors are used. If a single cell fails to work the buzzer strongly through the circuit, another cell must be added.

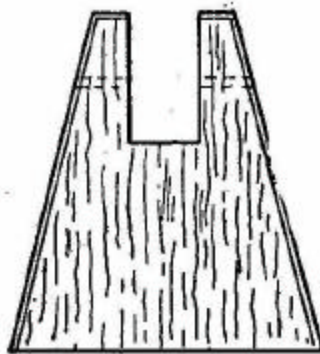

**FIG. 36.—Standard for  
sounder.**

FIG. 36. -- Standard for sounder.

For ease in transport it will be found advisable to mount key, buzzer, and battery on a common baseboard, which should be provided with a cover and handle. The three parts are interconnected with one another, and the line wire terminals as sketched in Fig. 34. This arrangement makes the apparatus very compact and self-contained. As a finishing touch fit the lid inside with clips for holding a stiff-backed writing pad and pencil for the recording of messages.

**Lines.** -- Fencing made of stout galvanized iron



wires strung on *wooden* posts supplies excellent conductors for practice purposes, provided the posts be quite dry. In wet weather there will be leakage. (Fencing with metal posts is, of course, unsuitable, as every post short-circuits the current.) The two wires selected for land lines must be scraped quite bright at the points where the connections are to be made.

It is an easy matter to rig up a telegraph line of galvanized wire 1/12 to 1/8 inch in diameter, strung along insulators (the necks of bottles serve the purpose excellently) supported on trees, posts, or rough poles. The length of the line will be limited by the battery power available, but a 6-volt battery at each end will probably suffice for all experimental purposes. A second wire is not needed if one terminal at each end is connected with a copper plate sunk in the ground, or with a metal fence, drain-pipe, etc.

**XI.**  
**A RECIPROCATING ELECTRIC MOTOR.**

The electric motor to be treated in this chapter illustrates very prettily the attractive force of a hollow, wire-wound bobbin on a movable core, when the electric current is passed through the wire. If one inserts the end of an iron rod into the coil, the coil exerts a pull upon it, and this pull will cease only when the centre of the rod is opposite the centre of the coil. This principle is used in the "electric gun," which in its simplest form is merely a series of powerful coils arranged one behind another on a tube through which an iron or steel projectile can pass. The projectile closes automatically the circuit of each coil in turn just before reaching it, and breaks it before its centre is halfway through the coil, being thus passed along from one coil to the other with increasing velocity.

Our motor is essentially a very inefficient one, its

energy being small for the current used, as compared with a revolving motor of the usual kind. But it has the advantage of being very easy to make.

**How it works.** -- The experimental engine, constructed in less than a couple of hours, which appears in Fig. 38, consists of a coil, C, strapped

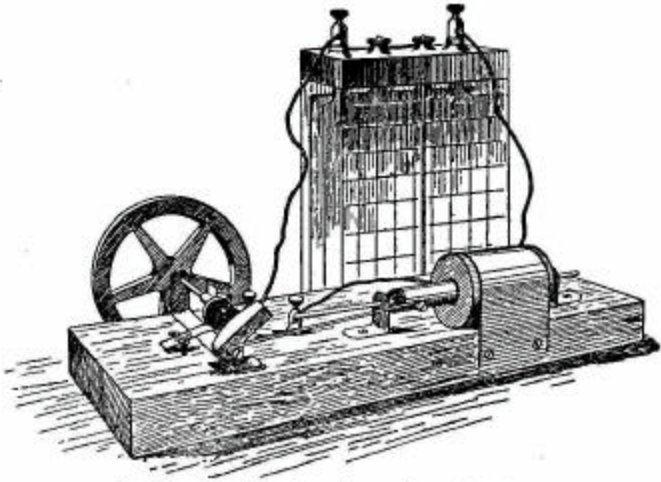

**FIG. 37.**—Electric reciprocating engine and battery.

FIG. 37. -- Electric reciprocating engine and battery.

down by a piece of tin to a wooden bedplate; a moving plunger, P, mounted on a knitting-needle slide rod, SR; a wire connecting rod, SR; a wooden crank, K; and a piece of knitting-needle for crank shaft, on which are mounted a small eccentric brass wipe, W, and a copper collar, D. Against

D presses a brass brush, B1 connected with the binding post, T1; while under W is a long strip of springy brass against which W presses during part of every revolution. T2 is connected to one end of the coil winding, and T1 through a 4-volt accumulator or three dry cells, with the other end of the coil. When W touches B2 the circuit is completed, and the coil draws in the plunger, the contact being broken before the plunger gets home. The crank rotates at a very high speed if there is plenty of battery power, all the moving parts appearing mere blurs.

### **CONSTRUCTION.**

The coil is made by winding 4 oz. of No. 32 cotton-covered wire (price 6d. to 8d.) on a boxwood reel 2 inches long and 1-1/2 inches in diameter, with a 9/16-inch central hole. Before winding, bore a hole for the wire through one end of the reel, near the central part, and mount the reel on a lathe or an improvised spindle provided with a handle of some kind. The wire should be uncoiled and wound on some circular object, to ensure its paying out regularly without kinking; which makes neat winding almost impossible.

Draw a foot of the wire through the hole in the

reel, and drive in a tiny peg -- which must not protrude inwards -- to prevent it slipping. Lay the turns on carefully, forcing them into close contact, so that the next layer may have a level bed. On reaching the end of the layer, be equally careful to finish it neatly before starting back again. When the wire is all on, bore a hole as near the edge of the finishing edge as possible, and draw the spare wire through. Then cut a strip of tough paper of the width of the coils, coat one side with paste, and wrap it tightly round the outside to keep the wire in place.

*Note.* -- Insulation will be improved if every layer of wire is painted over with shellac dissolved in alcohol before the next layer is applied.

Flatten the reel slightly with a file at the points of contact with the baseboard, to prevent rolling.

The plunger is a tube of thin iron, 1/16 inch less in diameter than the hole in the reel, and 1/4 inch longer than the reel. If a ready-made tube is not available, construct one by twisting a piece of tin round a metal rod, and soldering the joint. As it is difficult to make a jointed tube cylindrical, and a close fit is needed to give good results, it is worth going to a little trouble to get a plunger of the right kind.

The ends of the plunger are plugged with wood

and bored centrally for the slide rod, which should not be cut to its final length until the parts are assembled.

The crank shaft is 2-3/4 inches of a stout knitting needle mounted in a sheet brass bearing. The crank, a fragment of oak or other tough wood, is balanced, and has a throw of 5/8 inch. The crank-shaft hole should be a trifle small, so that the crank shall get a tight hold of the shaft without pinning. The collar, D, and wipe, W, are soldered to the shaft after this has been passed through its bearings. The brush B1 should press firmly, but not unnecessarily so, against the collar. For B2 one must use very springy brass strip, a piece about 3 inches long and 1/4 inch wide being needed. Bend it to the arc of a large circle, and screw one end down to the base by the binding screw T2. The other end, which should not touch the base, is confined by the heads of a couple of small screws, by means of which the strip is adjusted relatively to the wipe.

**Fixing the Coil.** -- Cut a strip of tin 1-3/4 inches wide and 4 inches long. Punch a couple of holes near one end, and nail this to the side of the base, with its forward end 4-1/4 inches from the crank shaft. Pass the strip over the coil, and bend it down towards the base. Drill a couple of screw holes, and screw the other end down so that the coil is gripped fairly tight.

**Fixing the Plunger.** Two small guides, G1 G2, are made for the plunger. The holes through which the slide rod moves should be a good fit, and their centres at the level of the centre of the coil. Screw holes are bored in the feet.

Pass the plunger through the coil, and place the guides on the rod. Then draw the plunger forward till 1/2 inch projects. Bring G1 close up to it, mark its position, and screw it to the base. The other guide, G2, should be 1-1/2 inches away from the rear of the coil.

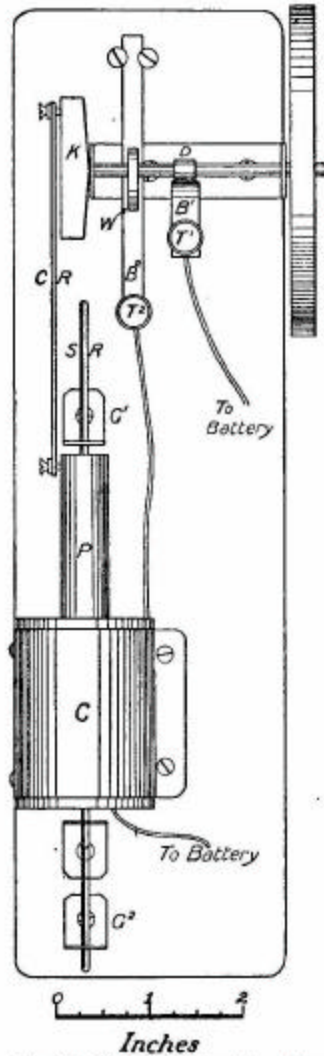

FIG. 38.—Plan of electric reciprocating engine.

Fig. 38. -- Plan of electric reciprocating engine.

The coil and guides must be adjusted so that the plunger does not touch the coil anywhere during a stroke, packings being placed, if necessary, under coil or guides. When the adjustment is satisfactory, screw the coil down tightly, and cut off any superfluous parts of the rod.

**The Connecting Rod.** -- Bore a hole near the end of the plunger for a screw to hold the rear end of the connecting rod. Pull the plunger out till 1-3/4 inches project, turn the crank full forward, and measure off the distance between the centres of the plunger hole and the crank pin. Drive a couple of wire nails into a board, and twist the ends of a piece of 1/20-inch wire round them twice. This wire constitutes a connecting rod amply strong enough to stand the pulls to which it will be subjected. Fix the rod in position.

**Adjusting the Wipe.** -- Turn the wipe, W, round until it makes contact with B2, and, holding the crank shaft with a pair of pliers, twist the crank on it till it just begins the return stroke. Then turn the crank to find out how long the wipe remains in contact, and adjust the crank relatively to the wipe so that the crank is vertical when the period of contact is half finished. The length of this period is controlled by the set screws at the free end of B2.



**OTHER DETAILS.**

The *fly wheel* may be a disc of wood.

Oil all the rubbing parts slightly. Connect T1 to one terminal of the battery, T2 to the coil, and the other terminal of the battery to the coil. Set the engine going. If it refuses to run, make sure that B1 is pressing against D. The speed of the engine may possibly be improved by careful adjustment of B2 and an alteration in the setting of the crank, and will certainly be accelerated by increasing the number of battery cells.

The cost of the engine described was about 1s, 3d., exclusive of the battery.

**XII.**  
**AN ELECTRIC ALARM CLOCK.**

Anybody who possesses an alarm clock with an external gong, an electric bell, and a battery, may easily make them combine to get the drowsiest of mortals out of bed on the chilliest of winter mornings. The arrangement has as its secondary advantages and capabilities --

(1) that the clock can be placed where its ticking will not disturb the person whom it has to arouse in due course (some of the cheaper clocks are very self-advertising);

(2) that one clock can be made to operate any number of bells in different parts of the house.

The main problem to be solved is, how to make the alarm mechanism of the clock complete an electric circuit when the alarm "goes off."

If you examine an alarm clock of the type described, you will find that the gong hammer lies against the gong when at rest, and that its shaft

when in motion vibrates to and fro about a quarter of an inch.

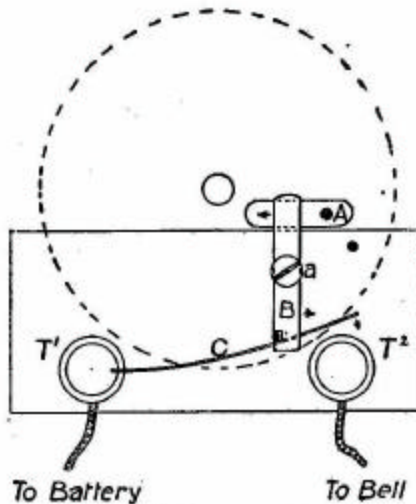

FIG. 89.—Plan of release gear of electric alarm, as attached to clock.

FIG. 89. - Plan of release gear of electric alarm, as attached to clock.

Fig. 39 shows a method of utilizing the movement of the hammer. A piece of wood, 2 inches long, wide enough to fill the space between the rear edge of the clock and the hammer slot, and 1/2 inch thick, has its under side hollowed out to the curvature of the clock barrel. This block serves as a base for two binding posts or terminals, T1 T2. A vertical slit is made in T1 and in this is soldered [to] one end of a little piece of spring brass strip, 1 inch long and 1/4 inch wide. To the back of the other end of the strip solder a piece of 1/20 inch wire, projecting 1 inch below the strip. The strip must be bent so that it presses naturally against T2. A little trigger, B, which you can cut out of sheet brass, is pivoted at *a*, where it must be raised

off the base by a small washer. It projects 1/4 inch beyond the base on the gong support side. A square nick is cut in it at such a distance from *a* that, when the wire spike on C is in the nick, the strip is held clear of T2. The other end of the trigger, when the trigger is set, must be 1/8 inch from the shank of the alarm hammer -- at any rate not so far away that the hammer, when it vibrates, cannot release C from the nick.

To fix the base on to the top of the clock, the works must be removed (quite an easy matter to accomplish) and holes bored for a couple of screws put through from the inside. If the underside of the base is not quite correctly curved, take care not to force in the screws far enough to distort the barrel. It is advisable to do the fitting of the parts of the release after the base has been fixed, and before the works are replaced. The position of the hammer shaft can be gauged accurately enough from the slot in the case.

The tails of the terminals T1 T2 must be truncated sufficiently not to penetrate the base and make contact with the barrel, or a "short circuit" will be evident as soon as the battery is connected up.

If the bell, battery, and clock are in the same

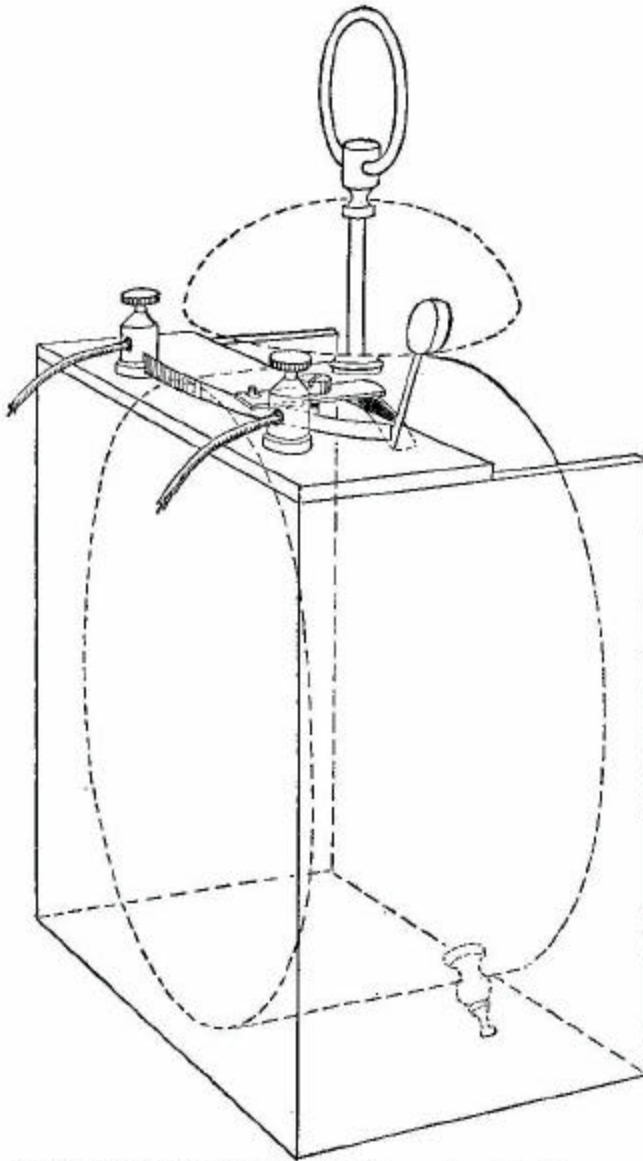

FIG. 40.—Electric alarm releaser, as attached to separate wooden clock casing.

Fig. 40. -- Electric alarm releaser, as attached to separate wooden clock casing

room, a single dry cell will give sufficient current; but if the circuit is a long one, or several bells have to be operated, two or more cells will be required.

**An Alternative Arrangement.** -- Should the reader prefer to have the clock quite free from the release -- and this is certainly convenient for winding and setting the alarm -- he should make a little wooden case for the clock to stand in, just wide enough to take the clock, and the back just as high as the top of the barrel. The release is then attached to a little platform projecting from the back, care being taken that the lever is arranged in the correct position relatively to the hammer when the clock is pushed back as far as it will go (Fig. 40).

If a self-contained outfit is desired, make the case two-storied: the upper division for the clock, the lower for the cell or cells. The bell may be attached to the front. A hinged fretwork front to the clock chamber, with an opening the size of the face; a door at the back of the cell chamber; and a general neat finish, staining and polishing, are refinements that some readers may like to undertake.

**Setting the Alarm.** -- A good many alarm clocks

are not to be relied upon to act within a quarter of an hour or so of the time to which they are set. But absolute accuracy of working may be obtained if the clock hands are first set to the desired hour, and the alarm dial hand revolved slowly till the alarm is released. The hands are then set at the correct time, and the alarm fully wound.

**XIII.**  
**A MODEL ELECTRIC RAILWAY.**

The rapid increase in the number of electrically worked railways, and the substitution of the electric for the steam locomotive on many lines, give legitimate cause for wondering whether, twenty or so years hence, the descendants of the "Rocket" will not have disappeared from all the railways of the world, excepting perhaps those of transcontinental character.

The change is already spreading to model plant, and not without good reason, as the miniature electric railway possesses decided advantages of its own. Instead of having to chase the locomotive to stop or reverse it, one merely has to press a button or move a switch. The fascinations of a model steam locomotive, with its furnace, hissing of steam, business-like puffings, and a visible working of piston and connecting rods, are not to be denied,



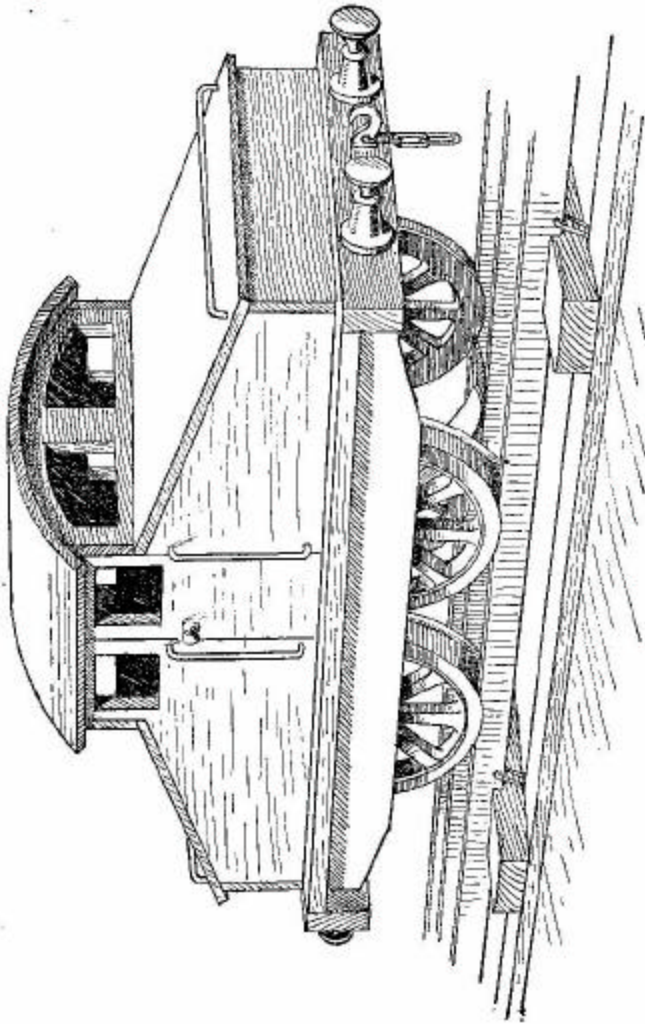

*FIG. 41.—Electric locomotive.*

Fig. 41. -- Electric Locomotive

any more than that a full-sized steam locomotive is a more imposing object at rest or in motion than its electric rival. On the other hand, the ease of control already noticed, and the absence of burning fuel, water leakage, smoke and fumes, are strong points in favour of the electric track, which does no more harm to a carpet than to a front lawn, being essentially clean to handle. Under the head of cost the electric locomotive comes out well, as motors can be purchased cheaply; and connecting them up with driving wheels is a much less troublesome business than the construction of an equally efficient steamer. One may add that the electric motor is ready to start at a moment's notice: there is no delay corresponding to that caused by the raising of steam.

### **The Track**

We will consider this first, as its design must govern, within certain limits, the design of the locomotive. There are three systems of electrical transmission available.

1. The trolley system, with overhead cable attached to insulators on posts, to carry the current one way, the rails being used as the "return." This system has the disadvantages associated with a wire over which the human foot may easily trip with disastrous effect.

2. That in which one of the wheel rails is used for taking the current to the motor, and the other as the return. The objection to the system is that the wheels must be insulated, to prevent short circuiting; and this, besides causing trouble in construction, makes it impossible to use the ordinary model rolling stock. To its credit one may place the fact that only two rails are needed.

3. The third and, we think, best system, which has an insulated third rail as one half of the circuit, and both wheel rails as the return, the motor being kept in connection

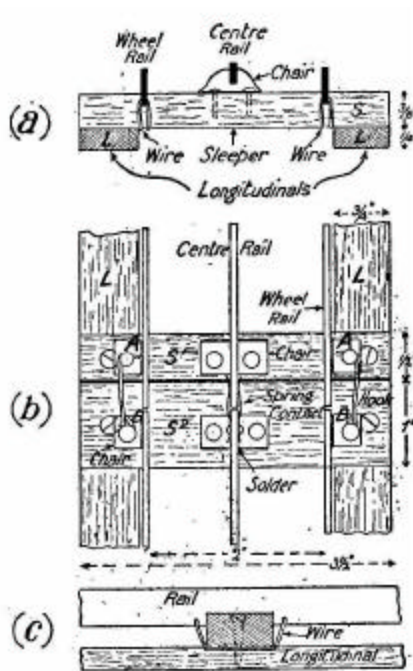

FIG. 42.—Details of rails for electric track.

FIG. 42. -- Details of rails for electric track.

with the third rail by means of a collector projecting from the frame and pressing against the top of the third rail. The last, for reasons of convenience, is placed between the wheel rails. We will assume that this system is to be employed.

**Gauge.** -- For indoor and short tracks generally it is advisable to keep the gauge narrow, so that sharp curves may be employed without causing undue friction between rails and wheels. In the present instance we specify a 2-inch gauge, for which, as also for 1-1/2 and 1-1/4 inch, standard rolling stock is supplied by the manufacturers.

**Track Construction.** -- It is essential that the centre rail and at least one of the wheel rails shall have all joints bonded together to give a clear course to the electric current, and the centre rail must be insulated to prevent leakage and short-circuiting. Where a track is laid down more or less permanently, the bonding is most positively effected by means of little fish-plates, screwed into the sides of the abutting rails; but in the case of a track which must be capable of quick coupling-up and uncoupling, some such arrangement as that shown in Fig. 42 is to be recommended.

Fig. 42 (*a*) is a cross vertical section of the track;

Fig. 42 (c) a longitudinal view; while Fig. 42 (b) shows in plan a point of junction of two lengths of rail.

The wheel rails are made of carefully straightened brass strip  $\frac{3}{8}$  inch wide and  $\frac{1}{16}$  inch thick, sunk rather more than  $\frac{1}{8}$  inch into wooden sleepers (Fig. 42, a), 3- $\frac{1}{2}$  inches long and  $\frac{3}{4}$  inch wide (except at junctions). The sleepers are prepared most quickly by cutting out a strip of wood 3- $\frac{1}{2}$  inches wide in the direction of the grain, and long enough to make half a dozen sleepers. Two saw cuts are sunk into the top, 2 inches apart, reckoning from the inside edges, to the proper depth, and the wood is then subdivided along the grain. The saw used should make a cut slightly narrower than the strip, to give the wood a good hold. If the cut is unavoidably too large, packings of tin strip must be forced in with the rail on the outside. To secure the rails further, holes are bored in them on each side of the sleeper (see Fig. 42, c), and fine iron or brass wire is passed through these, round the bottom of the sleeper, and made fast.

The centre rail is soldered to small tin chairs, the feet of which are pinned down to the sleepers.

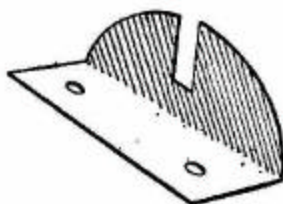

FIG. 43.—Tin chair for centre rail of electric track.

FIG. 43. -- Tin chair for centre rail of electric track.

The top of the rails must project slightly above the chairs, so that the current collector may not be fouled.

**Junctions.** -- At these points one 3/4-inch sleeper is reduced to 1/2-inch width, and the other increased to 1 inch, this sleeper being overlapped 3/8 inch by the rails of the other section. To the outsides of the wheel rails are soldered the little angle plates, AA, BB, attached to the sleepers by brass tacks, which project sufficiently to take the brass wire hooks. These hooks must be of the right length to pull upon the tacks in AA and make a good contact. The centre rails are bonded by two strips of springy brass, riveted to one section, and forced apart at their free end by the interposed strip. Two pins projecting from the narrower sleeper fit into holes in the wider to keep the sections in line at a junction.

**General.** -- The sleepers of straight sections are screwed down to 3/4 by 1/4 inch longitudinals, which help to keep the track straight and prevent the sleepers slipping. Sections should be of the same length and be interchangeable. Make straight sections of the greatest convenient length, to reduce the number of junctions. Sleepers need not be

less than 6 inches apart. Fix the sleepers on the longitudinals before hammering the rails into the slots.

**Curves.** -- A simple method of laying out a semi-circular curve is shown in Fig. 44. Sleepers and longitudinals are replaced by 1/2-inch boards, 8 inches wide. Three pieces, about 32 inches long each,

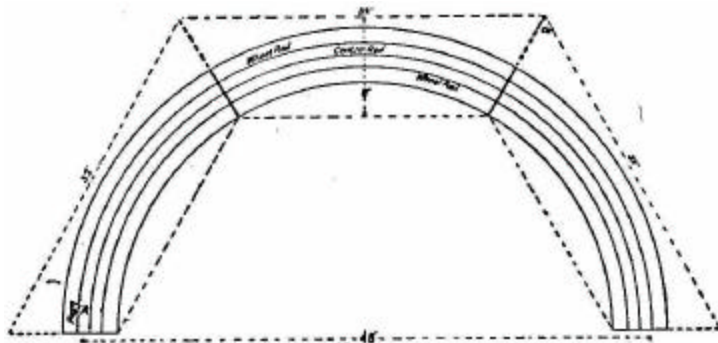

FIG. 44. -- Laying out a curve for electric track.

have their ends bevelled off at an angle of 60 degrees, and are laid with their ends touching. Two semi-circles of 24 and 22 inch radius are drawn on the boards to indicate the positions of the rails, and short decapitated brass nails are driven in on each side of a rail, about an inch apart, as it is laid along one of these lines. (See Fig. 44. A.) The inside nails must not project sufficiently to catch the wheel flanges. The spring of the brass will

prevent the rail falling out of place, but to make sure, it should be tied in with wire at a few points. The centre rail should on the curves also be  $\frac{3}{8}$  inch deep, and raised slightly above the bed so as to project above the wheel rails. The method already described of bonding at joints will serve equally well on curves. If the outer rail is super-elevated slightly, there will be less tendency for the rolling stock to jump the track when rounding the curve.

When the rails are in place the boards may be cut with a pad-saw to curves corresponding with the breadth of the track on the straight. If the boards incline to warp, screw some pieces of  $\frac{1}{8}$ -inch strip iron to the under side across the grain, sinking the iron in flush with the wood.

The brass strip for the rails costs about one penny per foot run. Iron strip is much cheaper, but if it rusts, as it is very likely to do, the contact places will need constant brightening.

**Points.** -- Fig. 45 shows the manner of laying out a set of points, and connecting up the rails. The outside wheel rails, it will be seen, are continuous, and switching is effected by altering the position of the moving tongues, pivoted at PP, by means of the rod R, which passes through a hole in the



continuous rail to a lever or motor of the same reversible type as is used for the locomotive. If a motor is employed, R should be joined to a crank pin on the large driven cog--corresponding to that affixed to the driving wheel (Fig. 47)--by a short rod. The pin is situated at such a distance from the axle of the cog wheel that a quarter of a revolution suffices to move the points over. The

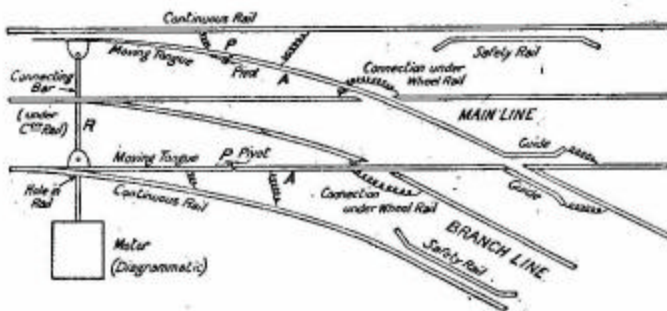

FIG. 45.--Points for electric railway.

FIG. 45. -- Points for electric railway.

points motor must, of course, have its separate connections with the "central station." To show how the points lie, the rod R also operates a semaphore with a double arm (Fig. 46), one end of which is depressed--indicating that the track on that side is open--when the other is horizontal, indicating "blocked." The arms point across the track.

**Details.** -- The tongues must be bevelled off to

a point on the sides respectively nearest to the continuous rails. The parts AA are bent out at the ends to make guides, which, in combination with the safety rails, will prevent the wheels jumping the track. Care should be taken to insulate centre rail connecting wires where they pass through or under the wheel rails.

It is advisable to lay out a set of points, together with motor and signals, on a separate board.

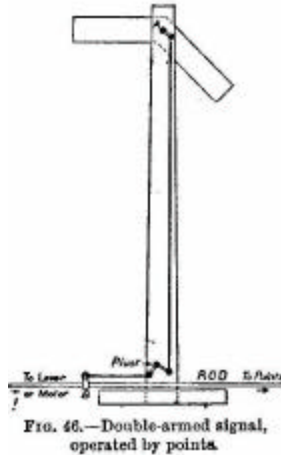

Fig. 46. -- Double-armed signal, operated by points.

**Preservation of Track.** -- All the wooden parts of an outdoor track should be well creosoted before use.

### The Electric Locomotive.

An elevation and a plan of this are given in Fig. 47. The two pairs of wheels are set close together, so that they may pass easily round curves.

**The Motor.** -- A motor of ordinary type, with electro field magnets, is unsuitable for traction, as it cannot be reversed by changing the direction of the current, unless a special and rather expensive

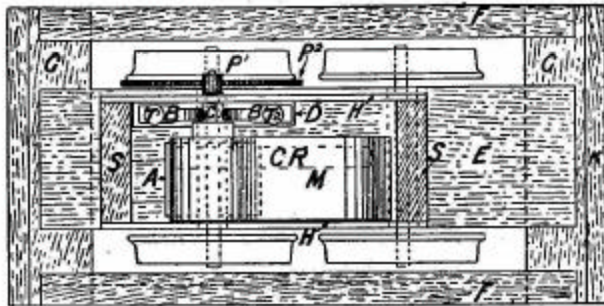

PLAN (a)

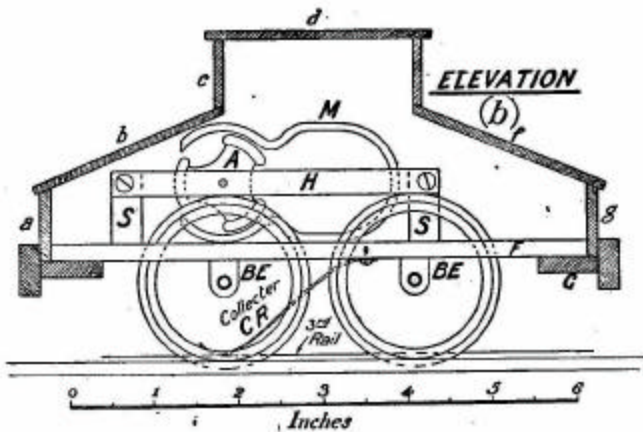

FIG. 47.—Plan and elevation of electric locomotive.

Fig. 47. -- Plan and elevation of electric locomotive.

type of automatic switch be used. While a motor of this kind is, in conjunction with such a switch, the most efficient, the motor with permanent field

magnets is preferable as regards cost and ease of fixing. It can be reversed through the rails. The armature or revolving part must be *tripolar* to be self-starting in all positions.

A motor of sufficient power can be bought for half a crown or less--in any case more cheaply than it can be made by the average amateur.

The motor used for the locomotive illustrated was taken to pieces, and the magnet M screwed to a strip of wood 1-5/8 inches wide; and for the original armature bearings were substituted a couple of pieces of brass strip, HH, screwed to two wooden supports, SS, on the base, E (Fig. 47, *a*). It was found necessary to push the armature along the spindle close to the commutator piece, C, and to shorten the spindle at the armature end and turn it down to the size of the original bearing, in order to bring the motor within the space between the wheels.

The place of the small pulley was taken by an 8-toothed pinion wheel, engaging with a pinion soldered to the near driving wheel, the diameter of which it exceeded by about 3/16 inch. The pair, originally parts of an old clock purchased for a few pence, gave a gearing-down of about 9 times.

The position of the driven wheels relatively to

the armature must be found experimentally. There is plenty of scope for adjustment, as the wheels can be shifted in either direction longitudinally, while the distance between wheel and armature centres may be further modified in the length of the bearings, BE. These last are pieces of brass strip turned up at the ends, and bored for axles, and screwed to the under side of the base. To prevent the axles sliding sideways and the wheels rubbing the frame, solder small collars to them in contact with the inner side of the bearings.

**The Frame.** -- Having got the motor wheels adjusted, shorten E so that it projects 2 inches beyond the centres of the axles at each end. Two cross bars, GG, 3-1/2 inches long, are then glued to the under side of E, projecting 1/8 inch. To these are glued two 3/8-inch strips, FF, of the same length as E. A buffer beam, K, is screwed to G. A removable cover, *abedfg*, is made out of cigar-box wood or tin. The ends rest on GG; the sides on FF. Doors and windows are cut out, and handrails, etc., added to make the locomotive suggest the real thing--except for the proportionate size and arrangement of the wheels.

**Electrical Connections.** -- The current collector, CR, should be well turned up at the end, so as not to catch on the centre rail joints, and not press hard enough on the rail to cause noticeable resistance. The fixed end of CR is connected through T2 with one brush, B, and both wheel bearings with T1.

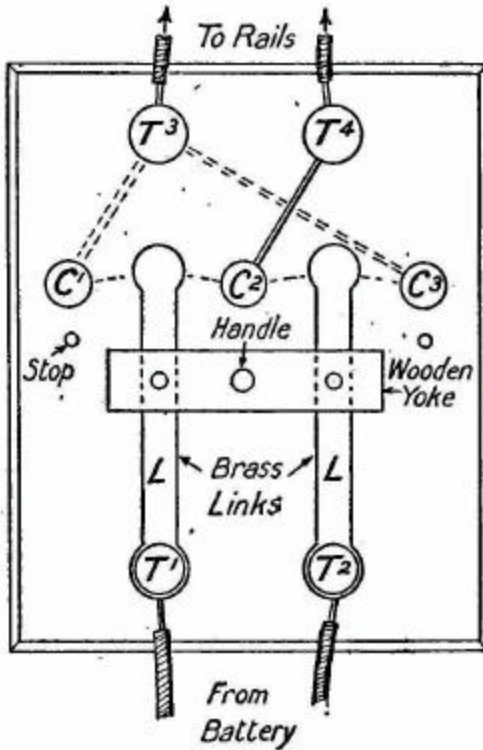

FIG. 48.—Reversing switch.

FIG. 48. -- Reversing switch.

**Electrical Fittings.** -- The best source of power to use is dry cells giving 1-1/2 to 2 volts each. These can be bought at 1s. apiece in fairly large sizes. Four or five connected in series will work quite a long line if the contacts are in good condition.

A reversing switch is needed to alter the direction of the current flow. The construction of one is an exceedingly simple matter. Fig. 48 gives a plan of switch and connection, from which the principle of the apparatus will be gathered. The two links, LL, are thin springy brass strips slightly curved, and at the rear end pivoted on the binding posts T1 T2. Underneath the other ends solder the heads of a couple of brass nails. The links are held parallel to one another by a wooden yoke, from the centre of which projects a handle. The three contacts C1 C2 C3 must be the same distance apart as the centres of the link heads, and so situated as to lie on the arcs of circles described by the links. The binding post T3 is connected with the two outside contacts--which may be flat-headed brass nails driven in almost flush with the top of the wooden base--by wires lying in grooves under the base, and T4 with the central contact. As shown, the switch is in the neutral position and the circuit broken.

**Multiple Battery Switch.** -- To control the speed of the train and economize current a multiple battery switch is useful. Fig. 49 explains how to make and connect up such a switch. The contacts, C1 to C5, lie in the path of the switch lever, and are connected through binding posts T1 to T6 with one terminal of their respective cells. The cells are coupled up in series to one another, and one terminal of the series with binding posts T0 and T6. By moving the lever, any number of the cells can be put in circuit with T7. The button under the head of the lever should not be wide enough to bridge the space between any two contacts. Change the order of the cells occasionally to equalize the exhaustion.

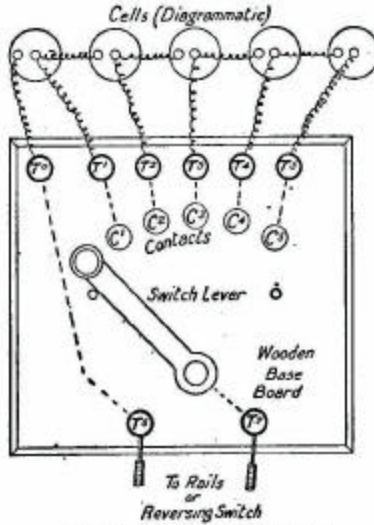

FIG. 49.—Multiple battery switch.

Fig. 49. -- Multiple battery switch.

**Resistance.** -- With accumulators, a "resistance" should be included in the circuit to regulate the flow of current. The resistance shown in Fig. 50 consists of a spiral of fine German silver wire lying in the grooved circumference of a wood disc.

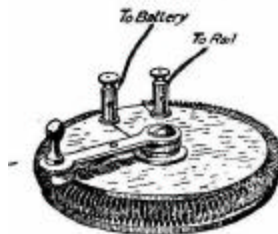

FIG. 50.—Adjustable resistance for controlling current.

FIG. 50. -- Adjustable resistance for controlling current.



One of the binding posts is in connection with the regulating lever pivot, the other with one end of the coil. By moving the lever along the coil the amount of German silver wire, which offers resistance to the current, is altered. When starting the motor use as little current as possible, and open the resistance as it gets up speed, choking down again when the necessary speed is attained.

**General.** -- All the three fittings described should for convenience be mounted on the same board, which itself may form the cover of the box holding the dry cells or accumulators.

### SOME SUGGESTIONS.

Instead of dry cells or accumulators a small foot or hand operated dynamo generating *direct*, not alternating current, might be used. Its life is indefinitely long, whereas dry cells become exhausted with use, and accumulators need recharging from time to time. On occasion such a dynamo might prove very convenient.

Anyone who possesses a fair-sized stationary engine and boiler might increase the realism of the outdoor track by setting up a generating station, which will give a good deal of extra fun.

#### **XIV. A SIMPLE RECIPROCATING ENGINE.**

Figs. 51 and 52 illustrate a very simple form of fixed-cylinder engine controlled by a slide valve.

An open-ended "trunk" piston, similar in principle to that used in gas engines, is employed; and the valve is of the piston type, which is less complicated than the box form of valve, though less easily made steam-tight in small sizes. The engine is single-acting, making only one power stroke per revolution.

The cylinder is a piece of brass tubing; the piston another piece of tubing, fitting the first telescopically. Provided that the fit is true enough to prevent the escape of steam, while not so close as to set up excessive friction, a packing behind the piston is not needed; but should serious leakage be anticipated, a packing of thick felt or cloth, held up by a washer and nuts on the gudgeon G, will make things secure. Similarly for the built-up piston valve P may be substituted a piece of close-fitting brass rod with diameter reduced, except at the ends, by filing or turning, to allow the passage of steam.

**CONSTRUCTION.**

The *bed* is made of wood, preferably oak, into the parts of which linseed oil is well rubbed before they

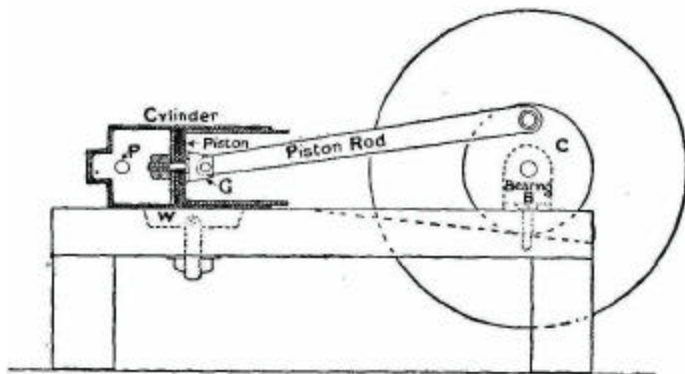

FIG. 51.—Elevation of simple reciprocating steam engine.

FIG. 51. -- Elevation of simple reciprocating steam engine.

are screwed together, to prevent the entry of water. A longitudinal groove is sawn in the top of the bed, as indicated by the dotted line in Fig. 51, to give room for the connecting rod in its lowest position, and a cross groove is scooped in line with the crank shaft to accommodate the lower part of the crank disc and the big end of the rod. (If the wing W under the

cylinder is screwed to the side of the bed, instead of passing through it, as shown, a slight cutting away of the edge will give the necessary clearance in both cases. )

The *cylinder* and *valve tube* A should be flattened by filing and rubbing on emery cloth, so that they may bed snugly against one another and give a good holding surface for the solder. A steam port, S P, should

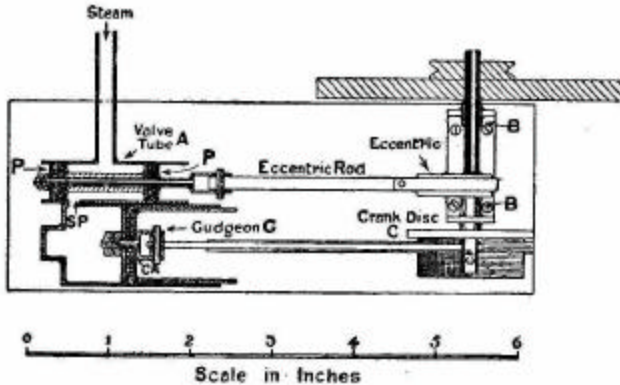

FIG. 52.—Plan of simple reciprocating steam engine.

FIG. 52. -- Plan of simple reciprocating steam engine.

next be bored in each, and the "burr" of the edges cleaned off carefully so as not to obstruct valve or piston in the slightest degree. "Tin" the contact surfaces thinly, and after laying valve tube and cylinder in line, with the portholes corresponding exactly, bind them tightly together with a turn or two of wire, or

hold them lightly in a vice, while the solder is made to run again with the aid of a spirit lamp. If it seems necessary, run a little extra solder along the joint, both sides, and at the ends.

The *valve*, if built up, consists of a central rod, threaded at the rear end, four washers which fit the tube, and a central spacing-piece. The forward washer is soldered to the rod. Behind this is placed a felt packing. Then come in order the central spacing-piece, with a washer soldered to each end, a second packing, and a fourth washer. The series is completed by an adjusting nut to squeeze the packings, and a lock nut to prevent slipping. The back end of the valve must be wide enough to just more than cover the steam port. If the felt proves difficult to procure or fit, one may use a ring or two of brass tubing, with an external packing of asbestos cord.

The cylinder *wing* W should have the top edge turned over for an eighth of an inch or so to give a good bearing against the cylinder, and be held in position by a wire while the soldering is done. It is important that the line of the wing should be at right angles to a line passing through the centres of the valve tube and cylinder.

**Shaft Bearings.** -- Take a piece of strip brass half an

inch or so wide and 3-1/2 inches long. Bore four holes for screws, and scratch cross lines an inch from each extremity. Turn up the ends at these lines at right angles to the central part, stand the piece on some flat surface, and on the outer faces of the uprights scratch two cross lines at the height of the centre of the cylinder above the bed. Mark the central points of these lines.

Next select a piece of brass tubing which fits the rod chosen for the crank shaft, and bore in the bearing standards two holes to fit this tubing. Slip the tubing through the standards and solder it to them. The ends and central parts of the tubing must now be so cut away as to leave two bearings, BB -- that at the fly-wheel end projecting far enough to allow the fly wheel, when brought up against it, to just clear the bed; that at the crank end being of the proper length to allow the eccentric to be in line with the valve rod, and the crank disc to occupy its proper position relatively to the central line of the cylinder. Finish off the standards by filing the tops concentrically with the bearings.

The eccentric may be built up from a metal disc about 3/4 inch diameter and two slightly larger discs soldered concentrically to the sides. The width of

the middle disc should be the same as that of the eccentric rod. A careful filer could make a passable eccentric by sinking a square or semicircular groove in the edge of a wide disc. The centre of the eccentric must be found carefully, and a point marked at a distance from it equal to half the travel of the valve. To ascertain this, pull the valve forward until the steam port is fully exposed, insert a bar at the rear end of the valve tube, and mark it. Then push the valve back until a wire pushed through the port from the cylinder side shows that the port is again fully exposed. Insert and mark the bar again. The distance between the marks gives you the "travel" required.

**Order of Assembly.** -- The following list of operations in their order may assist the beginner:

Make the bed.

Cut out cylinder barrel, piston, and valve tube.

Bevel off the ends of the last inside to allow the valve to enter easily.

Make the valve.

Bore the steam ports, and solder valve tube and cylinder together.

Solder holding-down wing, W, to cylinder.

Finish off the piston.

Solder the bearings in their standards.

Prepare shaft, crank disc, crank pin, and piston rod.

Fix the cylinder to the bed, in which a slot must be cut for the wing and holding-down bolt.

Attach the piston rod to the piston, and insert piston in cylinder.

Bore hole for shaft in centre of crank disc, and another, 9/16 inch away (centre to centre), for crank pin.

Solder in crank pin squarely to disc.

Pass shaft through bearings and slip on the crank disc.

Pass front end of piston rod over the crank pin.

Lay bearing standard on bed squarely to the centre line of the cylinder, turn crank fully back, and move the standard about till the back end of the piston clears the back end of the cylinder by about 1/32 inch.

Get standard quite square, and adjust sideways till connecting rod is in line with axis of cylinder.

Mark off and screw down the standard.

Make the eccentric, eccentric rod, and strap. Slip eccentric on shaft.

Put valve in position and draw it forward till the port is exposed.

Turn the eccentric forward, and mark the rod opposite centre of valve pin.



Bore hole for pin, and insert pin.

Hold the crank shaft firmly, and revolve eccentric till the port just begins to open on its forward stroke. Rotate crank disc on shaft till the crank pin is full forward.

Solder eccentric and disc to shaft.

Solder steam pipe to cylinder, and a brass disc to the rear end of the cylinder.

Fit a fly wheel of metal or wood. This must be fairly heavy, as it has to overcome all friction during the return or exhaust stroke.

**Action of Engine.** -- During the forward motion of the piston the valve is pushed back by the eccentric until the steam port is fully opened, and is then drawn forward, covering the port. At the end of the power stroke the port has begun to open to the air, to allow the steam to escape throughout the exhaust stroke, in the course of which the valve is pushed back until, just at the end of the stroke, the steam port begins to open again.

*Notes.* --

(1.) The connecting rod may be made shorter than shown in Figs. 51 and 52; but in that case the piston also must be shortened to allow for the greater obliquity of the rod at half-stroke.

(2.) If two opposed cylinders are made to operate the one crank, a double-acting engine is obtained. Both valves may be operated by a single eccentric, the connecting rod of one being pivoted to a small lug projecting from the eccentric strap. If *three* cylinders are set 120 degrees apart round the crank shaft, a continuous turning effect is given. This type will be found useful for running small dynamos.

(3.) If it is desired to use the exhaust steam to promote a draught in the boiler furnace, it should be led away by a small pipe from the rear end of the valve tube.

**XV.****A HORIZONTAL SLIDE-VALVE ENGINE.**

The reader who has succeeded in putting together the simple engine described in the preceding chapter may wish to try his hand on something more ambitious in the same line. The engine illustrated in Figs. 53 to 66 will give sufficient scope for energy and handiness with drill and soldering iron. The writer made an engine of the same kind, differing only from that shown in the design of the crosshead guides, without the assistance of a lathe, except for turning the piston and fly wheel -- the last bought in the rough. Files, drills, taps, a hack saw, and a soldering iron did all the rest of the work.

Solder plays so important a part in the assembling of the many pieces of the engine that, if the machine fell into the fire, a rapid disintegration would follow. But in actual use the engine has proved very satisfactory; and if not such as the highly-skilled model-maker with a well-equipped workshop at his command would prefer to expend his time on, it will afford a useful lesson in the use of the simpler tools. Under 50 lbs. of steam it develops sufficient power to run a small electric-lighting installation, or to do other useful work on a moderate scale.

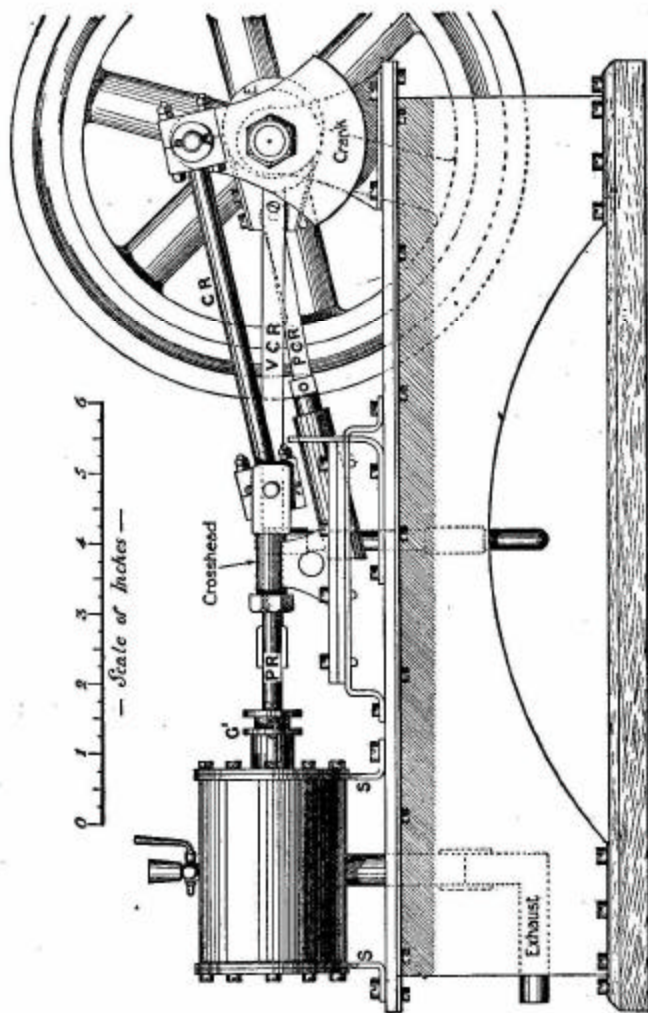

Fig. 53.—Elevation of large horizontal engine.

Fig. 53. -- Elevation of a large horizontal engine.

The principal dimensions of the engine are as follows ;-

*Bedplate* (sheet zinc), 13-1/2 inches long; 4-1/2 inches wide; 1/8 inch thick.

*Support of bedplate* (1/20 inch zinc), 3 inches high from wooden base to underside of bedplate.

*Cylinder* (mandrel-drawn brass tubing), 1-1/2 inches internal diameter; 2-13/16 inches long over all.

*Piston*, 1-1/2 inches diameter; 1/2 inch long.

*Stroke of piston*, 2-1/4 inches.

*Connecting rod*, 5 inches long between centres;  
5/16 inch diameter.

*Piston rod*, 5-1/8 inches long; 1/4 inch diameter.

*Valve rod*, 4-1/8 inches long; 3/16 inch diameter.

*Crank shaft*, 5 inches long; 1/2 inch diameter.

*Centre line of piston rod*, 1-1/4 inches laterally from near edge of bed; 1-5/8 inches from valve-rod centre line; 1-5/8 inches vertically above bed.

*Centre line of crank shaft*, 10-3/8 inches from cross centre line of cylinder.

*Bearings*, 1 inch long.

*Eccentric*, 9/32-inch throw.

*Fly wheel*, diameter, 7-1/2 inches; width, 1 inch; weight, 6 lbs.

*Pump*, 3/8-inch bore; 3/8-inch stroke; plunger, 2 inches long.

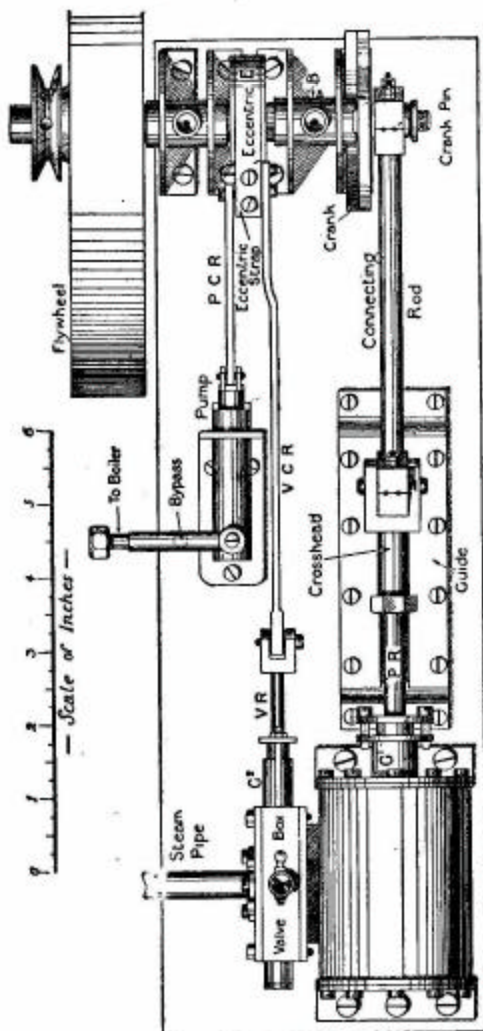

FIG. 54.—Plan of large horizontal engine.

Fig. 54. -- Plan of a large horizontal engine

Other dimensions will be gathered from the various diagrams of details.

The reader will, of course, suit his own fancy in following these dimensions, or in working to them on a reduced scale, or in modifying details where he considers he can effect his object in a simpler manner.

The diagrams are sufficiently explicit to render it unnecessary to describe the making of the engine from start to finish, so remarks will be limited to those points which require most careful construction and adjustment.

**The Bedplate.** -- This should be accurately squared and mounted on its four arch-like supports. (For dimensions, consult Fig. 55.) Half an inch is allowed top and bottom for the turnovers by which the supports are screwed to the bedplate and base. The ends of the longer supports are turned back so as to

lie in front of the end supports, to which they may be attached by screws or solder, after all four parts

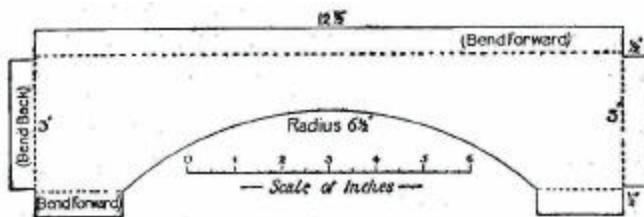
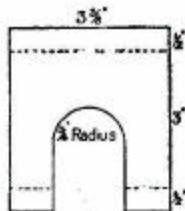

FIG. 55.—Standards of bedplate.

Fig. 55. -- Standards of Bedplate



have been screwed to the bed. Care must be taken that the parts all have the same height. Drill all holes in the turnovers before bending. Use 1/8-inch screws. Turn the bed bottom upwards, and stand the four supports, temporarily assembled, on it upside down and in their correct positions, and mark off for the 3/32-inch holes to be drilled in the bed. A hole 3/4 inch in diameter should be cut in the bedplate for the exhaust pipe, round a centre 2 inches from the end and 1-5/8 inches from the edge on the fly-wheel side, and two more holes for the pump.

**Making the Cylinder Slide and Valve.** -- The cylinder barrel must be perfectly cylindrical and free from



any dents. Mandrel-drawn brass tubing, 1/16-inch thick, may be selected. If you cannot get this turned off at the ends in a lathe, mark the lines round it for working to with the aid of a perfectly straight edged strip of paper, 2-13/16 inches wide, rolled twice round the tube. The coils must lie exactly under one another. Make plain scratches at each end of the paper with a sharp steel point. Cut off at a distance of 1/16-inch from the lines, and work up to the lines with a file, finishing by rubbing the ends on a piece of emery cloth resting on a hard, true surface.

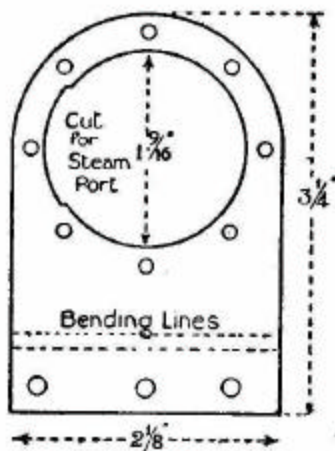

FIG. 56.—Cylinder standard before being bent.

FIG. 56.-Cylinder standard before being bent.

A square-cornered notch 1/8 inch deep and 7/8 inch wide must now be cut in each end of the barrel, the two notches being exactly in line with one another. These are to admit steam from the steam ways into the cylinder.

**Cylinder Standards.**-Use  $5/64$  or  $3/32$  inch brass plate for these. Two pieces of the dimensions shown in Fig. 56 are needed. Scratch a line exactly down the middle of each, and a cross line  $1/2$  inch from one end. The other end should be marked, cut, and filed to a semicircle. Drill three  $3/16$ -inch holes in the turnover for the holding-down screws. The two standards should now be soldered temporarily together at the round ends and trued up to match each other exactly. Place them in the vice with the bending lines exactly level with the jaws, split the turnovers apart, and hammer them over at right angles to the main parts. Whether this has been done correctly may be tested by placing the standards on a flat surface. Take the standards apart, and scratch a cross line on each  $1-5/8$  inch from the lower surface of the foot on the side away from the foot. Make a punch mark where the line crosses the vertical line previously drawn, and with this as centre describe a circle of the diameter of the outside of the barrel. Cut out the inside and file carefully up to the circle, stopping when the barrel makes a tight fit. On the inside of the hole file a nick  $1/8$  inch deep, as shown in Fig. 56. Remember that this nick must be on the left of one standard and on the right of the other, so that they shall pair off properly.

Standards and barrel must now be cleaned for soldering. Screw one standard down to a wood base; slip one end of the barrel into it; pass the

other standard over the other end of the barrel, and adjust everything so that the barrel ends are flush with the, outer surfaces of the standard, and the nicks of the barrel in line with the standard nicks. Then screw the other standard to the base. Solder must be run well into the joints, as these will have to stand all the longitudinal working strain.

The next step is the fitting of the cylinder covers. If you can obtain two stout brass discs 2-1/8 inches in diameter, some trouble will be saved; otherwise you must cut them out of 3/32-inch plate. The centre of each should be marked, and four lines 45 degrees apart be scratched through it from side to side. A circle of 15/16-inch radius is now drawn to cut the lines, and punch marks are made at the eight points of intersection. Solder the covers lightly to the foot side of their standards, marked sides outwards, and drill 1/8-inch holes through cover and standard at the punch marks. Make matching marks on the edges. Unsolder the covers, enlarge the holes in them to take 5/32-inch screws; and tap the holes in the standards. This method will ensure the holes being in line, besides avoiding the trouble of marking off the standards separately.

Bore a 1/4-inch hole in the centre of one cover--be sure that it is the right one--for the piston rod.

You can now proceed to the making of the piston-rod gland (Fig. 54, G1). Fig. 57 shows how this is built up of pieces of tubing and brass lugs for the screws. If possible, get the tubular parts trued in a lathe.

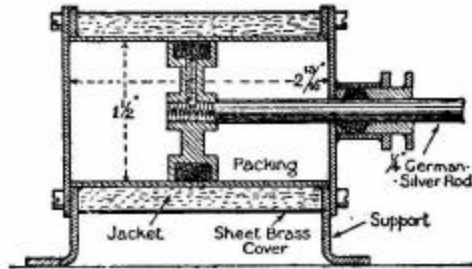

FIG. 57.--Vertical section of cylinder.

FIG. 57. -- Vertical section of cylinder.

Before the gland is soldered to the cover, the cover should be put in place, the piston rod attached to the piston, and the parts of the gland assembled. Push the piston rod through the cover until the piston is hard up against the back of the cover. Slip the gland over the rod, turn it so that the screws are parallel to the foot of the standard, and make the solder joint. This is the best way of getting the gland exactly concentric with the cylinder

so that the piston rod shall move without undue friction. But you must be careful not to unsolder the cylinder from its standard or the parts of the gland. Blacken the piston rod in a candle flame to prevent solder adhering.

**Steam Chest.** -- The walls of the steam chest are best made in one piece out of 1/2-inch brass by cutting out to the dimension given in Fig. 58. A sharp fret saw will remove the inside rectangle. Get both inside and outside surfaces as square as possible in all directions, and rub down the two contact faces on emery cloth supported by an old looking-glass.

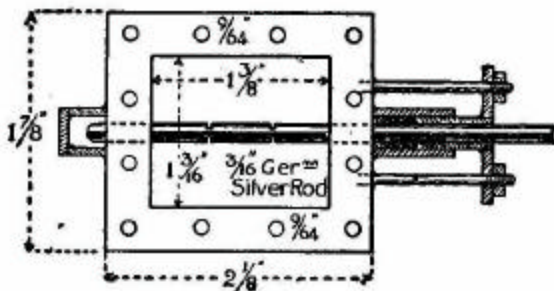

FIG. 58.—Wall-piece for steam chest, with gland and valve rod in position.

FIG. 68.—Wall-piece for steam chest, with gland and valve rod in position.

Two perfectly flat plates of 1/8-inch brass are cut to the size given in Fig. 59, or a little longer both ways, to allow for working down to the same area as the wall-piece. This operation should be carried out after soldering the three pieces together. File and rub the sides until no projections are visible. Then drill twelve 3/32-inch holes right through the three parts. After separating them, the holes in the walls and what will be the cover must be enlarged to an easy fit for 1/8-inch bolts, and the valve plate tapped.

Now drill  $3/16$ -inch holes centrally through the ends of the walls for the valve rod. If the first hole is drilled accurately, the second hole should be made without removing the drill, as this will ensure the two holes being in line. If, however, luck is against you, enlarge the holes and get the rod into its correct position by screwing and soldering small drilled plates to the outside of the chest. Also drill and tap a hole for the lubricator. The attachment of the gland (Fig. 54, G2) is similar to that of the cylinder gland, and therefore need not be detailed.

**The Valve Plate (Fig. 59).** -- Three ports must be cut in this--a central one,  $7/8$  by  $3/32$  inch, for the exhaust; and two inlets,  $7/8$  by  $3/32$  inch,  $1/8$  inch away from the exhaust. These are easily opened out if a series of holes be drilled along their axes.

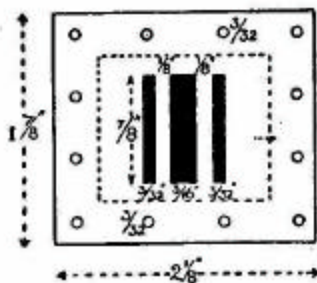

FIG. 59.—Valve plate.

FIG. 69. - Valve plate.

**The Steam Ways.** -- The formation of the steam ways between valve plate and cylinder is the most ticklish bit of work to be done on the engine as it entails the making of a number of solder joints close together.

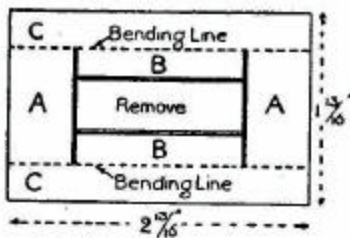

FIG. 60.—Piece for steam ways.

FIG. 60. -- Piece for steam ways.

We begin by cutting out of 1/20-inch sheet brass a piece shaped as in Fig. 60. Parallel to the long edges, and 3/8 inch away, scribe bending lines. Join these by lines 5/8 inch from the short edges, and join these again by lines 1/4 inch from the bending lines. Cuts must now be made along the lines shown double in Fig. 60. Bend parts CC down and parts BB upwards, so that they are at right angles to parts AA. The positions of these parts, when the piece is applied to the cylinder, are shown in Fig. 62.

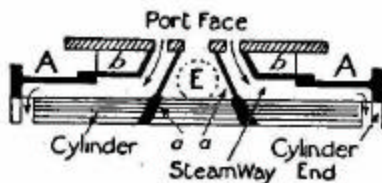

FIG. 61.—Valve plate and steam ways in section.

FIG. 61. -- Valve plate and steam ways in section.

One must now make the bridge pieces (Fig. 61, *a, a*) to separate the inlet passages from the exhaust. Their width is the distance between the bent-down pieces CC of Fig. 60, and their bottom edges are shaped to the curvature of the cylinder barrel. Finally, make the pieces *bb*

(Fig. 61), which form part of the top of the steam ways.

In the assembling of these parts a blowpipe spirit lamp or a little "Tinol" soldering lamp will prove very helpful.

The following order should be observed:-

(1.) Solder the piece shown in Fig. 60 to the

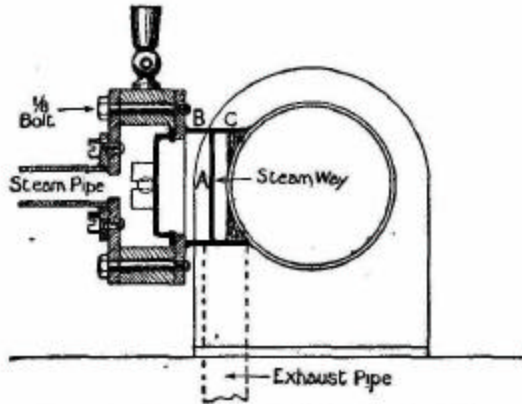

FIG. 62.—Cross section of cylinder and valve chest.

FIG. 62.-Cross section of cylinder and valve chest.

cylinder barrel by the long edges, and to the cylinder supports at the ends. This piece must, of course, cover the steam ports in the cylinder.

(2.) Put pieces *aa* (Fig. 61) in position, with their tops quite flush with the tops of *BB* (Fig. 62), and solder them to the cylinder barrel and sides of the steam-way piece.



(3.) Solder the valve plate centrally to BB, and to the tops of *aa*, which must lie between the central and outside ports. Take great care to make steam-tight joints here, and to have the plate parallel to the standards in one direction and to the cylinder in the other.

(4.) Solder in pieces *bb*. These should be a tight fit, as it is difficult to hold them in place while soldering is done.

(5.) Bore a 5/16-inch hole in the lower side of the central division and solder on the exhaust pipe.

**Slide Valve.** -- The contact part of this is cut out of flat sheet brass (Fig. 63), and to one side is soldered a cap made by turning down the edges of a cross with very short arms. The little lugs *aa* are soldered to this, and slotted with a jeweller's file to engage with notches cut in the valve rod (see Figs. 58 and 62).

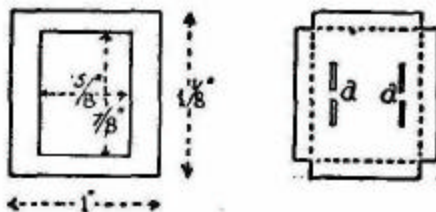

FIG. 63.—Parts of slide valve.

FIG. 63.-Parts of slide valve.

**The Crank and Crank Shaft.** -- The next thing to take in hand is the fixing of the crank shaft. This is a piece of 3/8 or 1/2 inch steel rod 5 inches long.

The bearings for this may be pieces of brass tubing, fitting the rod fairly tight. By making them of

good length--1 inch--the wear is reduced to almost nothing if the lubricating can is used as often as it should be.

Each bearing is shown with two standards. The doubling increases rigidity, and enables an oil cup to be fixed centrally.

The shape of the standards will be gathered from Fig. 53, their outline being dotted in behind the crank.

Cut out and bend the standards--after drilling the holes for the foot screws--before measuring off for the centres of the holes; in fact, follow the course laid down with regard to the cylinder standards.

Make a bold scratch across the bedplate to show where the centre line of the shaft should be, and another along the bed for the piston-rod centre line. (Position given on p. 138.)

Bore holes in the bearings for the oil cups, which may be merely forced in after the engine is complete.

The crank boss may be made out of a brass disc 2-3/4 inches diameter and 3/16 inch thick, from which two curved pieces are cut to reduce the crank to the shape shown in Fig. 53. The heavier portion, on the side of the shaft away from the crank pin, helps to counterbalance the weight of the connecting and

piston rods. In Fig. 54 (plan of engine) you will see that extra weight in this part has been obtained by fixing a piece of suitably curved metal to the back of the boss.

The mounting of the crank boss on the shaft and the insertion of the crank pin into the boss might well be entrusted to an expert mechanic, as absolute "squareness" is essential for satisfactory working. Screw-thread attachments should be used, and the crank-shaft should project sufficiently to allow room for a flat lock nut. The crank pin will be rendered immovable by a small lock screw penetrating the boss edgewise and engaging with a nick in the pin.

**Fixing the Standards and Bearings.** -- Place the two bearings in their standards and slip the crank shaft through them. Place standards on the bed, with their centre lines on the crank-shaft centre line. The face of the crank should be about  $\frac{3}{8}$  inch away from the piston rod centre line. Bring the nearer bearing up against the back of the disc, and arrange the standards equidistantly from the ends of the bearing. The other bearing should overlap the edge of the bed by about  $\frac{1}{8}$  inch. Get all standards square to the edge of the bed, and mark off the positions of screw holes in bed. Remove the standards, drill and

tap the bed-plate holes, and replace parts as before, taking care that the lubricating holes in the bearings point vertically upwards. Then solder bearings to standards.

If any difficulty is experienced in getting all four standards to bed properly, make the bearing holes in the two inner ones a rather easy fit. The presence of the crank-shaft will assure the bearings being in line when the soldering is completed.

The standards and bed should have matching marks made on them.

**The Eccentric.** -- This can be formed by soldering two thin brass discs  $1-15/16$ -inch diameter concentrically to the sides of a disc of  $1-15/16$ -inch diameter and  $5/16$  inch thick. The centre of the shaft hole must be exactly  $9/32$  inch from the centre of the eccentric to give the proper valve-travel. Drill and tap the eccentric edgeways for a lock screw.

A piece to which the eccentric strap, eccentric rod, and pump rod are attached is cut out of  $5/16$ -inch brass. Its shape is indicated in Fig. 53. The side next the eccentric must be shaped as accurately as possible to the radius of the eccentric. The *strap*, of strip brass, is fastened to the piece by four screws, the eccentric rod by two screws.

**Crosshead and Guides.** -- The crosshead (Figs. 53 and 54) is built up by soldering together a flat foot of steel, a brass upright, and a tubular top fitting the piston rod. The guides, which consist of a bed, covers, and distance-pieces united by screws (Fig. 64), have to withstand a lot of wear, and should preferably be of steel. The importance of having them quite flat and straight is, of course, obvious.



**FIG. 64. — Cross section of crosshead and guide.**

FIG. 64. - Cross section of crosshead and guide.

The last 1-3/8 inches of the piston rod has a screw thread cut on it to engage with a threaded hole in the fork (cut out of thick brass plate), to which the rear end of the connecting rod is pinned, and to take the lock nut which presses the crosshead against this fork.

Assuming that all the parts mentioned have been prepared, the cylinder should be arranged in its proper place on the bed, the piston rod centrally over its centre line. Mark and drill the screw holes in the bed.

**The Valve Gear.** -- We may now attend to the valve gear. A fork must be made for the end of the valve rod, and soldered to it with its slot at right angles to the slots which engage with the valve lugs. Slip the rod into the steam chest, put the valve on the rod,

and attach the chest (without the cover) to the valve plate by a bolt at each corner. Pull the valve forward till the rear port is just uncovered, and turn the eccentric full forward. You will now be able to measure off exactly the distance between the centres of the valve-rod fork pin and the rear screw of the eccentric. The valve connecting rod (Fig. 53, VCR) should now be made and placed in position. If the two forward holes are filed somewhat slot-shaped, any necessary adjustment of the valve is made easier. If the adjustment of VCR and the throw of the eccentric are correct, the valve will just expose both end ports alternately when the crank is revolved. If one port is more exposed than the other, adjust by means of the eccentric screws till a balance is obtained. Should the ports still not be fully uncovered, the throw of the eccentric is too small, and you must either make a new eccentric or reduce the width of the valve. (The second course has the disadvantage of reducing the expansive working of the steam.) Excess movement, on the other hand, implies too great an eccentric throw.

**Setting the Eccentric.** -- Turn the crank full forward, so that a line through the crank pin and shaft centres is parallel to the bed. Holding it in this

position, revolve the eccentric (the screw of which should be slackened off sufficiently to allow the eccentric to move stiffly) round the shaft in a clockwise direction, until it is in that position *below* the shaft at which the *front* steam port just begins to show. Then tighten up the eccentric lock screw.[1]

**The Connecting Rod.** -- The length of this from centre to centre of the pins on which it works should be established as follows:--Slip over the piston rod a disc of card 1/32 inch thick. Then pass the rod through the gland and assemble the crosshead and fork on its end, and assemble the guides round the crosshead foot. Turn the crank pin full forward, pull the piston rod out as far as it will come, measure the distance between pin centres very carefully, and transfer it to a piece of paper.

The rod consists of a straight central bar and two rectangular halved ends. The ends should be cut out of brass and carefully squared. Through their exact centres drill 1/8-inch holes, and cut the pieces squarely in two across these holes. The sawed faces should be filed down to a good fit and soldered together. Now

[Footnote 1: The reader is referred to an excellent little treatise, entitled "The Slide Valve" (Messrs. Percival Marshall and Co., 26 Poppin's Court, Fleet Street, E.C. Price 6d.), for a full explanation of the scientific principles of the slide valve.]

drill holes of the size of the pins, using what remains of the holes first made to guide the drill. The bolt holes are drilled next, and finally the holes for lubrication and those to take the rods. Then lay the two ends down on the piece of paper, so that their pinholes are centred on the centre marks, and the holes for the rod are turned towards one another. Cut off a piece of steel rod of the proper length and unsolder the ends. The rod pieces must then be assembled on the rod, and with it be centred on the paper and held in position while the parts are soldered together.

### **OTHER DETAILS.**

**Adjusting the Guides.** -- Put the connecting rod in place on its pins, and revolve the crank until the guides have taken up that position which allows the crosshead to move freely. Then mark off the holes for the guide holding-down screws, and drill and tap them.

**Packings.** -- The glands and piston should be packed with asbestos string. Don't be afraid of packing too tightly, as the tendency is for packing to get slacker in use. The rear end of the cylinder should be bevelled off slightly inside, to allow the packed piston to enter easily.



**Joints.** -- The cylinder head and valve chest joints should be made with stout brown paper soaked in oil or smeared with red lead. All screw holes should be cut cleanly through the paper, and give plenty of room for the screws.

When making a joint, tighten up the screws in rotation, a little at a time so as not to put undue strain

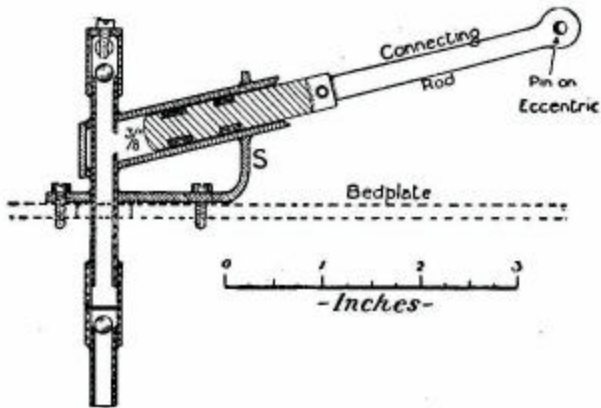

FIG. 66.—Vertical section of force pump driven by engine.

FIG. 66.—Vertical section of force pump driven by engine.

on any screw. Wait an hour or two, and go round with the screw-driver again.

**Lubrication.** -- When the engine is first put under steam, lubrication should be very liberal, to assure the parts "settling down" without undue wear.

**The Pump.** -- Fig. 65 shows in section the pump, which will be found a useful addition to the engine. (For other details, see Figs. 53 and 54.) Its stroke is only that of the eccentric, and as the water passages and valves are of good size, it will work efficiently at high speed. The method of making it will be obvious from the diagrams, and space will therefore not be devoted to a detailed description. The valve balls should, of course, be of gun-metal or brass, and the seatings must be prepared for them by hammering in a steel ball of the same size.

In practice it is advisable to keep the pump always working, and to regulate the delivery to the boiler by means of a by-pass tap on the feed pipe, through which all or some of the water may be returned direct to the tank.

The tank, which should be of zinc, may conveniently be placed under the engine. If the exhaust steam pipe be made to traverse the tank along or near the bottom, a good deal of what would otherwise be wasted heat will be saved by warming the feed water.

### **Making a Governor.**

It is a great advantage to have the engine automatically governed, so that it may run at a fairly constant speed under varying loads and boiler pressures.

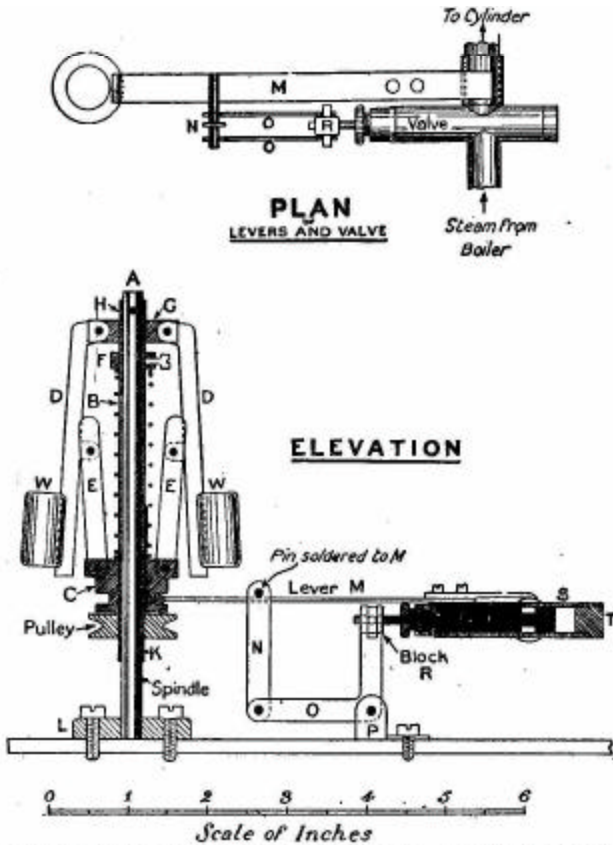

FIG. 66.—Elevation of governor for horizontal engine. Above is plan of valve and rod gear.

FIG. 66. -- Elevation of governor for horizontal engine. Above is plan of valve and rod gear.

In the absence of a governor one has to be constantly working the throttle; with one fitted, the throttle can be opened up full at the start, and the

automatic control relied upon to prevent the engine knocking itself to pieces.

The vertical centrifugal apparatus shown in Fig. 66 was made by the writer, and acted very well. The only objection to it is its displacement of the pump from the bed. But a little ingenuity will enable the pump to be driven off the fly wheel end of the crank shaft, or, if the shaft is cut off pretty flush with the pulley, off a pin in the face of the pulley.

Turning to Fig. 66, A is a steel spindle fixed in a base, L, screwed to the bed. B is a brass tube fitting A closely, and resting at the bottom on a 1/4-inch piece of similar tubing pinned to A.

A wooden pulley jammed on B transmits the drive from a belt which passes at its other end round a similar, but slightly larger, pulley on the crank shaft. This pulley is accommodated by moving the eccentric slightly nearer the crank and shortening the fly-wheel side bearing a little.

The piece G, fixed to B by a lock screw, has two slots cut in it to take the upper ends of the weight links DD; and C, which slides up and down B, is similarly slotted for the links EE. Each of the last is made of two similarly shaped plates of thin brass, soldered together for half their length, but separated

3/32 inch at the top to embrace the projections of D. To prevent C revolving relatively to B, a notch is filed in one side of the central hole, to engage with a piece of brass wire soldered on B (shown solid black in the diagram). A spiral steel spring, indicated in section by a number of black dots, presses at the top against the adjustable collar F, and at the bottom against C.

The two weights WW are pieces of brass bar slotted for driving on to DD, which taper gently towards the outer edge.

When the pulley revolves, centrifugal force makes WW fly outwards against the pressure of the spring, and the links EE raise C, which in turn lifts the end of lever M. A single link, N, transmits the motion from a pin on M to the double bell-crank lever O (see Fig. 66) pivoted on a standard, P, attached to the bedplate. The slotted upper ends of P engage with pins on an adjustable block, R, which moves the governing valve V (solid black), working in the tube S through a gland. The higher M is raised the farther back is V moved, and its annular port is gradually pushed more out of line with two ports in the side of the valve tube, thus reducing the flow of steam from the supply pipe to the cylinder

connection on the other side of the tube. This connection, by-the-by, acts as fulcrum for lever M, which is made in two parts, held together by screws, to render detachment easy.

The closer the fit that V makes with S the more effective will the governing be. The gland at the end of S was taken from an old cylinder cover.

Regulation of the speed may be effected either

- (1) by driving the governor faster or slower relatively to the speed of the crank shaft;
- (2) by altering the position of W on D;
- (3) by altering the compression of the spring by shifting F;
- (4) by a combination of two or more of the above.

Generally speaking, (3) is to be preferred, as the simplest.

The belt may be made out of a bootlace or fairly stout circular elastic. In either case the ends should be chamfered off to form a smooth joint, which may be wrapped externally with thread.

### **FINAL HINTS.**

All parts which have to be fitted together should have *matching marks* made on them with the punch. To take the parts of the valve chest as an example. As we have seen, these should be soldered together, finished off outside, and drilled. Before separating

them make, say, two punch marks on what will be the *upper* edge of the valve plate near the end, and two similar marks on the chest as near the first as they can conveniently be. In like manner mark the chest cover and an adjacent part of the chest with three marks. It is utterly impossible to reassemble the parts incorrectly after separation if the marks are matched. Marking is of greatest importance where one piece is held up to another by a number of screws. If it is omitted in such a case, you may have a lot of trouble in matching the holes afterwards.

Jacket the cylinder with wood or asbestos, covered in neatly with sheet brass, to minimize condensation. If the steam ways, valve chest, and steam pipe also are jacketed, an increase in efficiency will be gained, though perhaps somewhat at the expense of appearance.

**Boiler.** -- The boiler described on pp. 211-216, or a vertical multitubular boiler with about 800 sq. inches of heating surface will drive this engine satisfactorily.

**XVI  
MODEL STEAM TURBINES.**

Steam turbines have come very much to the fore during recent years, especially for marine propulsion. In principle they are far simpler than cylinder engines, steam being merely directed at a suitable angle on to specially shaped vanes attached to a revolving drum and shaft. In the Parsons type of turbine the steam expands as it passes through successive rings of blades, the diameter of which rings, as well as the length and number of the blades, increases towards the exhaust end of the casing, so that the increasing velocity of the expanding steam may be taken full advantage of. The De Laval turbine includes but a single ring of vanes, against which the steam issues through nozzles so shaped as to allow the steam to expand somewhat and its molecules to be moving at enormous velocity before reaching the vanes. A De Laval wheel revolves at



terrific speeds, the limit being tens of thousands of turns per minute for the smallest engines. The greatest efficiency is obtained, theoretically, when the vane velocity is half that of the steam, the latter, after passing round the curved inside surfaces of the vanes, being robbed of all its energy and speed. (For a fuller description of the steam turbine, see *How It Works*, Chap. III., pp.74-86.)

The turbines to be described work on the De Laval principle, which has been selected as the easier for the beginner to follow.

### **A Very Simple Turbine.**

We will begin with a very simple contrivance, shown in Fig. 67. As a "power plant" it is confessedly useless, but the making of it affords amusement and instruction. For the boiler select a circular tin with a jointless stamped lid, not less than 4 inches in diameter, so as to give plenty of heating surface, and at least 2-1/2 inches deep, to ensure a good steam space and moderately dry steam. A shallow boiler may "prime" badly, if reasonably full, and fling out a lot of water with the steam.

Clean the metal round the joints, and punch a small hole in the lid, half an inch from the edge, to give

gress to the heated air during the operation of soldering up the point or joints, which must be rendered absolutely water-tight.

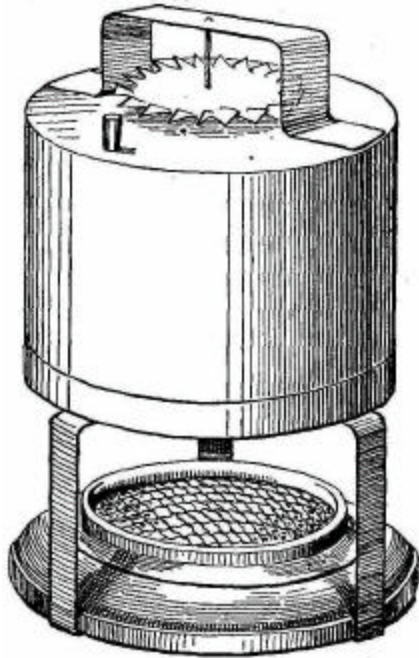

FIG. 67.—Simple steam turbine.

FIG. 67. -- Simple steam turbine.

For the turbine wheel take a piece of thin sheet iron or brass; flatten it out, and make a slight dent in it an inch from the two nearest edges. With this dent as centre are scribed two circles, of  $\frac{3}{4}$  and  $\frac{1}{2}$  inch radius respectively. Then scratch a series of radial marks between the circles, a fifth of an inch apart. Cut out along the outer circle, and with your shears follow the radial lines to the inner circle. The edge is thus separated into vanes (Fig. 68), the ends of which

must then be twisted round through half a right angle, with the aid of a pair of narrow-nosed pliers, care being taken to turn them all in the same direction.

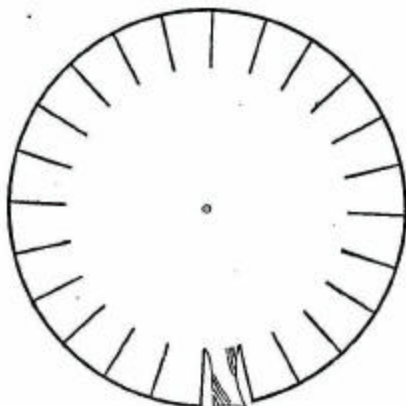

FIG. 68.—Wheel for steam turbine, showing one vane twisted into final position.

FIG. 68. -- Wheel for steam turbine, showing one vane twisted into final position.

A spindle is made out of a large pin, beheaded, the rough end of which must be ground or filed to a sharp point. Next, just break through the metal of the disc at the centre with a sharpened wire nail, and push the spindle through till it projects a quarter of an inch or so. Soldering the disc to the spindle is most easily effected with a blowpipe or small blow-lamp.

**The Boiler.** -- In the centre of the boiler make a dent, to act as bottom bearing for the spindle. From this centre describe a circle of  $5/8$ -inch radius. On this circle must be made the steam port or ports. Two ports, at opposite ends of a diameter, give better results than a single port, as equalizing the pressure

on the vanes, so that the spindle is relieved of bending strains. Their combined area must not, however, exceed that of the single port, if one only be used. It is important to keep in mind that for a turbine of this kind velocity of steam is everything, and that nothing is gained by increasing the number or size of ports if it causes a fall in the boiler pressure.

The holes are best made with a tiny Morse twist drill. As the metal is thin, drill squarely, so that the steam shall emerge vertically.

For the upper bearing bend a piece of tin into the shape shown in Fig. 67. The vertical parts should be as nearly as possible of the same length as the spindle. In the centre of the underside of the standard make a deep dent, supporting the metal on hard wood or lead, so that it shall not be pierced. If this accident occurs the piece is useless.

Place the wheel in position, the longer part of the spindle upwards, and move the standard about until the spindle is vertical in all directions. Scratch round the feet of the standard to mark their exact position, and solder the standard to the boiler. The top of the standard must now be bent slightly upwards or downwards until the spindle is held securely without being pinched.

A 3/16-inch brass nut and screw, the first soldered to the boiler round a hole of the same size as its internal diameter, make a convenient "filler;" but a plain hole plugged with a tapered piece of wood, such as the end of a penholder, will serve.

Half fill the boiler by immersion in hot water, the large hole being kept lowermost, and one of the steam vents above water to allow the air to escape.

A spirit lamp supplies the necessary heat. Or the boiler may be held in a wire cradle over the fire, near enough to make the wheel hum. Be careful not to *over-drive* the boiler. As a wooden plug will probably be driven out before the pressure can become dangerous, this is a point in favour of using one. Corrosion of the boiler will be lessened if the boiler is kept *quite full* of water when not in use.

### **A Practical Steam Turbine.**

The next step takes us to the construction of a small turbine capable of doing some useful work. It is shown in cross section and elevation in Fig. 69.

The rotor in this instance is enclosed in a case made up of two stout brass discs, D and E, and a 3/4-inch length of brass tubing. The plates should be 1/2-inch larger in diameter than the ring, if the bolts

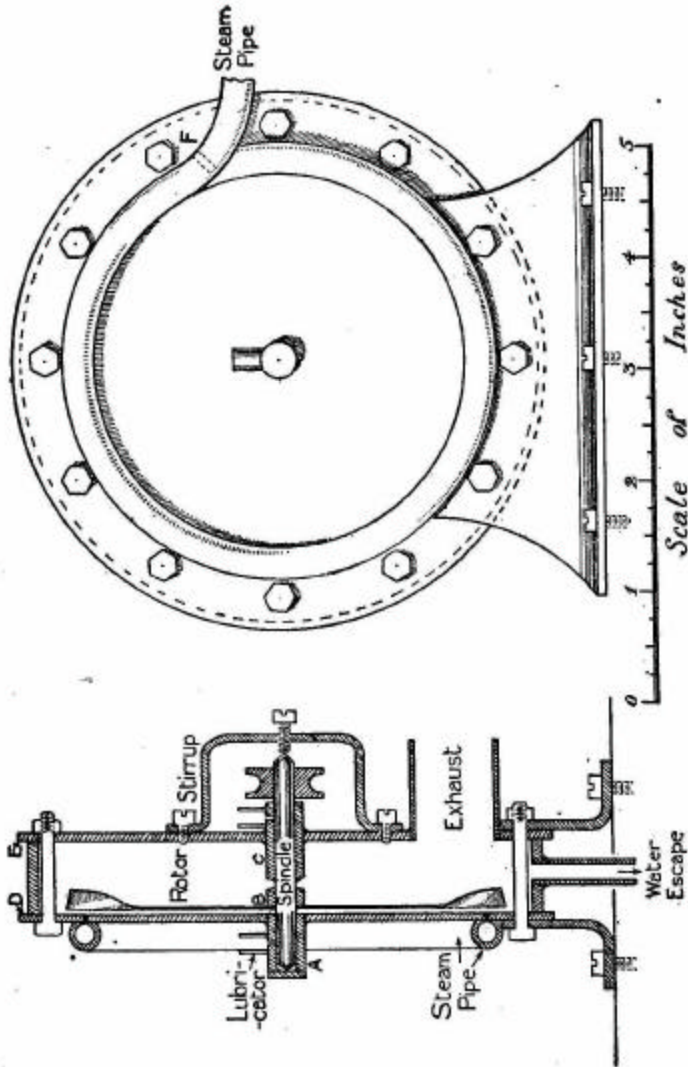

FIG. 69. -- Model steam turbine, showing vertical cross section (left) and external steam pipe (right).

FIG. 69. -- Model steam turbine, showing vertical cross section (left) and external steam pipe (right).

are to go outside. The stouter the parts, within reason, the better. Thick discs are not so liable to cockle as thin ones, and a stout ring will make it possible to get steam-tight joints with brown-paper packing.

The *wheel* is a disc of brass, say,  $1/25$  inch thick and 4 inches in diameter; the *spindle* is  $3/16$  inch, of silver steel rod; the *bearings*, brass tubing, making a close fit on the rod.

If you cannot get the ring ends turned up true in a lathe--a matter of but a few minutes' work--rub them down on a piece of emery cloth supported on a true surface, such as a piece of thick glass.

Now mark out accurately the centres of the discs on both sides, and make marks to show which face of each disc is to be outside.

On the outside of both scribe circles of the size of the bearing tubes, and other circles at the proper radius for the bolt hole centres.

On the outside of D scribe two circles of 2-inch and  $1-11/16$ -inch radius, between which the steam pipe will lie.

On the inside of D scribe a circle of  $1-27/32$ -inch radius for the steam ports.

On the outside of E mark a 7/8-inch circle for the exhaust pipe.  
On the inside of both mark the circles between which the ring must lie.

**Bolt Holes.** -- The marks for these, six or twelve in number, are equally spaced on the outside of one plate, and the two plates are clamped or soldered together before the boring is done, to ensure the holes being in line. If the bolts are to screw into one plate, be careful to make the holes of the tapping size in the first instance, and to enlarge those in D afterwards. Make guide marks in the plates before separating, between what will be the uppermost holes and the circumference.

**Bolts.** -- These should be of brass if passed inside the ring. Nuts are not necessary if E is tapped, but their addition will give a smarter appearance and prevent the bolts becoming loose.

**Bearings.** -- Bore central holes in the discs to a good fit for the bearings, and prepare the hole for the exhaust pipe. This hole is most easily made by drilling a ring of small holes just inside the mark and cutting through the intervening metal.

For A, B, and C cut off pieces of bearing pipe, 1/2, 1/4, and 3/4 inch long respectively, and bevel the ends of



B and C as shown, to minimize friction if they rub. File all other ends square. (Lathe useful here.)

Bore oil holes in B and C, and clear away all the "burr." Make scratches on the bearings to show how far they should be pushed through the case.

Now assemble the case, taking care that the edge of the ring corresponds exactly with the circles marked on the discs, and clean the metal round the bearing holes and the bearings themselves. The last are then placed in position, with the lubricating holes pointing upwards towards the guide marks on the discs. Push the spindle rod through the bearings, which must be adjusted until the rod can be revolved easily with the fingers. Then solder in the bearing with a "Tinol" lamp.

**The Wheel.** -- Anneal this well by heating to a dull red and plunging it in cold water. Mark a circle of 1-1/4-inch radius, and draw radial lines 1/4 inch apart at the circumference from this circle to the edge. Cut out along the lines, and twist the vanes to make an angle of about 60 degrees with the central part, and bend the ends slightly backward away from the direction in which the rotor will revolve. (The directions given on p. 189 for making a steam top wheel can be applied here.)

Bore a hole in the centre to make a tight fit with the spindle, and place the rotor in position, with piece B in contact on the C side. Get everything square (rotation will betray a bad wobble), and solder the three parts together with the blow-lamp.

Mount the rotor squarely by the spindle points between two pieces of wood held lightly in the vice, and, with the aid of a gauge fixed to the piece nearest the wheel, true up the line of the vanes. (Lathe useful here.)

**The Steam Pipe** is 15 inches (or more) of 5/16-inch copper tubing, well annealed. To assist the bending of it into a ring one needs some circular object of the same diameter as the interior diameter of the ring round which to curve it. I procured a tooth-powder box of the right size, and nailed it firmly to a piece of board. Then I bevelled off the end of the pipe to the approximately correct angle, laid it against the box, and drove in a nail to keep it tight up. Bending was then an easy matter, a nail driven in here and there holding the pipe until the ring was complete. I then soldered the end to the standing part, and detached the ring for flattening on one side with a file and emery cloth. This done, I bored a

hole through the tube at F to open up the blind end of the ring.

Attaching the ring to disc D is effected as follows: --Tin the contact faces of the ring and disc pretty heavily with solder, after making poppet marks round the guide circles so that they may not be lost under the solder. The ring must be pressed tightly against its seat while heating is done with the lamp. An extra pair of hands makes things easier at this point. Be careful not to unsolder the spindle bearing, a thing which cannot happen if the bearing is kept cool by an occasional drop or two of water. A little extra solder should be applied round the points where the ports will be.

**The Steam Ports.** -- These are drilled (with a 1/32-inch twist drill), at an angle of about 30 degrees to the plate, along the circle already scribed. If you have any doubt as to your boiler's capacity, begin with one hole only, and add a second if you think it advisable. As already remarked, pressure must not be sacrificed to steam flow.

**Lubricators** -- These are short pieces of tubing hollowed at one end by a round file of the same diameter as the bearings. A little "Tinol" is smeared over the surfaces to be joined, and the lubricators are

placed in position and heated with the blow-lamp until the solder runs. To prevent the oil flowing too freely, the lubricators should be provided with airtight wooden plugs.

**Escape Pipes.** -- The pipe for the exhaust steam is now soldered into disc E, and a small water escape into the ring at its lowest point. This pipe should be connected with a closed chamber or with the exhaust at a point lower than the base of the turbine case.

**Stirrup.** -- Fig. 69 shows a stirrup carrying a screw which presses against the pulley end of the spindle. This attachment makes it easy to adjust the distance between the rotor and the steam ports, and also concentrates all end thrust on to a point, thereby minimizing friction. The stirrup can be fashioned in a few minutes out of brass strip. Drill the holes for the holding-on screws; drill and tap a hole for the adjusting screw; insert the screw and centre it correctly on the spindle point. Then mark the position of the two screw holes in E; drill and tap them.

**Feet** are made of sheet brass, drilled to take the three (or two) lowermost bolts, and bent to shape. *Note.* -- A side and foot may be cut out of one piece of metal. The difficulty is that the

bending may distort the side, and prevent a tight joint between side and ring.

**Assembling.** -- Cut out two rings of stout brown paper a quarter of an inch wide and slightly larger in diameter than the casing ring. In assembling the turbine finally, these, after being soaked in oil, should be inserted between the ring and the discs. Put in four screws only at first, and get the ring properly centred and the bearings exactly in line, which will be shown by the spindle revolving easily. Then tighten up the nuts and insert the other bolts, the three lowest of which are passed through the feet. Affix the pulley and stirrup, and adjust the spindle longitudinally until the rotor just does not rub the casing. The soldering on of the cap of A completes operations.

To get efficiency, heavy gearing down is needed, and this can be managed easily enough with the help of a clockwork train, decreasing the speed five or more times for driving a dynamo, and much more still for slow work, such as pumping.

### **A More Elaborate Turbine.**

The turbine just described can hardly be termed an efficient one, as the vanes, owing to their simple

formation, are not shaped to give good results. We therefore offer to our readers a design for a small turbine of a superior character. This turbine is shown in elevation and section in Fig. 70. The casing is, as in the preceding instance, made up of flat brass plates and a ring of tubing, and the

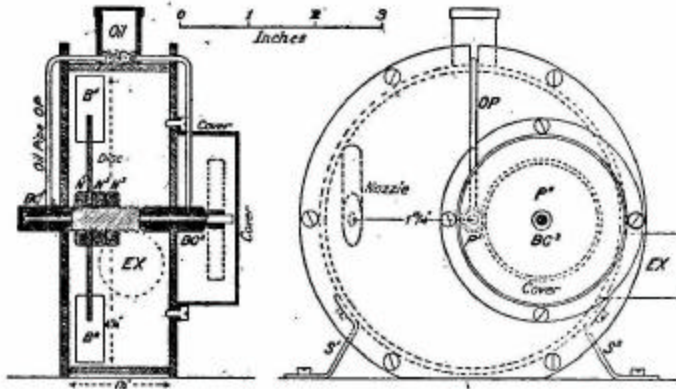

FIG. 70.—Vertical section of steam turbine with formed blades (left); outside view of turbine, gear side (right).

FIG. 70.- Vertical section of steam turbine with formed blades (left); outside view of turbine, gear side (right).

bearings, BG1, BG2, of brass tube. But the wheel is built up of a disc 3 inches in diameter, round the circumference of which are 32 equally-spaced buckets, blades, or vanes, projecting  $\frac{5}{8}$  inch beyond the edge of the disc. The wheel as a whole is mounted on a spindle  $3\frac{1}{8}$  inches long, to which it is secured by three nuts, N1 N2 N3. One end of the

spindle is fined down to take a small pinion, P1, meshing with a large pinion, P2, the latter running in bearings, BG3, in the wheel-case and cover. The drive of the turbine is transmitted either direct from the axle of P2 or from a pulley mounted on it.

### CONSTRUCTION.

**The Wheel.** -- If you do not possess a lathe, the preparation of the spindle and mounting the wheel disc

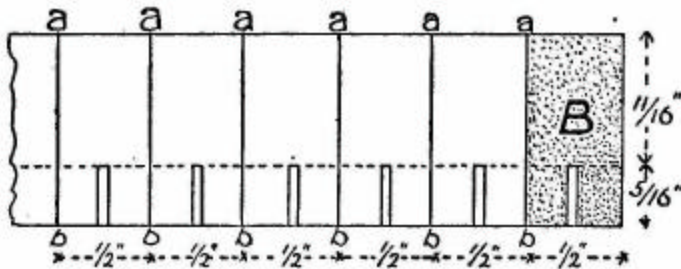

FIG. 71.—Plate marked out for turbine wheel blades. B is blade as it appears before being curved.

FIG. 71. -- Plate marked out for turbine wheel blades. B is blade as it appears before being curved.

on it should be entrusted to a mechanic. Its diameter at the bearings should be  $\frac{5}{32}$  inch or thereabouts. (Get the tubing for the bearings and for the spindle turned to fit.) The larger portion is about twice as thick as the smaller, to allow room for the screw threads. The right-hand end is turned down quite small for the pinion, which should be of driving fit.

**The Blades.** -- Mark out a piece of sheet iron as

shown in Fig. 71 to form 32 rectangles, 1 by 1/2 inch. The metal is divided along the lines *aaaa*, *bbbb*, and *ab*, *ab*, *ab*, *ab*, etc. The piece for each blade then has a central slot 5/16 inch long and as wide as the wheel disc cut very carefully in it.

**Bending the Blades.** -- In the edge of a piece of hard wood 1 inch thick file a notch 3/8 inch wide and 1/8 inch deep with a 1/2-inch circular file, and procure a metal bar which fits the groove loosely. Each blade is laid in turn over the groove, and the bar is applied lengthwise on it and driven down with a mallet, to give the blade the curvature of the groove. When all the blades have been made and shaped, draw 16 diameters through the centre of the wheel disc, and at the 32 ends make nicks 1/16 inch deep in the circumference.

True up the long edges of the blades with a file, and bring them off to a sharp edge, removing the metal from the convex side.

**Fixing the Blades.** -- Select a piece of wood as thick as half the width of a finished blade, less half the thickness of the wheel disc. Cut out a circle of this wood 2 inches in diameter, and bore a hole at the centre. The wheel disc is then screwed to a perfectly



flat board or plate, the wooden disc being used as a spacer between them.

Slip a blade into place on the disc, easing the central slit, if necessary, to allow the near edge to lie in contact with the board -- that is parallel to the disc. Solder on the blade, using the minimum of solder needed to make a good joint. When all the blades are fixed, you will have a wheel with the blades quite true on one side. It is, therefore, important to consider, before commencing work, in which direction the concave side of the blades should be, so that when the wheel is mounted it shall face the nozzle.

To make this point clear: the direction of the nozzle having been decided, the buckets on the trued side must in turn present their concave sides to the nozzle. In Fig. 70 the nozzle points downwards, and the left side of the wheel has to be trued. Therefore B1 has its convex, B2 its concave, side facing the reader, as it were.

**The Nozzle** is a 1-1/2 inch piece of brass bar. Drill a 1/20-inch hole through the centre. On the outside end, enlarge this hole to 1/8 inch to a depth of 1/8 inch. The nozzle end is bevelled off to an angle of 20 degrees, and a broach is inserted to give the steam port a conical section, as shown in Fig. 72, so that the steam may

expand and gain velocity as it approaches the blades. Care must be taken not to allow the broach to enter far enough to enlarge the throat of the nozzle to more than 1/20 inch.

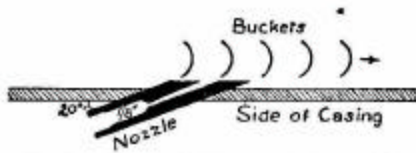

FIG. 72.—Nozzle of turbine, showing its position relatively to buckets.

FIG. 72. -- Nozzle of turbine, showing its position relatively to buckets.

**Fixing the Nozzle.** -- The centre of the nozzle discharge opening is 1-13/16-inches from the centre of the wheel. The nozzle must make an angle of 20 degrees with the side of the casing, through which it projects far enough to all but touch the nearer edges of the vanes. (Fig. 72.) The wheel can then be adjusted, by means of the spindle nuts, to the nozzle more conveniently than the nozzle to the wheel. To get the hole in the casing correctly situated and sloped, begin by boring a hole straight through, 1/4 inch away laterally from where the steam discharge hole will be, centre to centre, and then work the walls of the hole to the proper angle with a circular file of the same diameter as the nozzle piece, which is then sweated in with solder. It is, of course, an easy matter to fix the nozzle at the proper angle to a thin plate, which can be screwed on to the outside of the

casing, and this method has the advantage of giving easy detachment for alteration or replacement.

**Balancing the Wheel.** -- As the wheel will revolve at very high speed, it should be balanced as accurately as possible. A simple method of testing is to rest the ends of the spindle on two carefully levelled straight edges. If the wheel persists in rolling till it takes up a certain position, lighten the lower part of the wheel by scraping off solder, or by cutting away bits of the vanes below the circumference of the disc, or by drilling holes in the disc itself.

**Securing the Wheel.** -- When the wheel has been finally adjusted relatively to the nozzle, tighten up all the spindle nuts hard, and drill a hole for a pin through them and the disc parallel to the spindle, and another through N3 and the spindle. (Fig. 70.)

**Gearing.** -- The gear wheels should be of good width, not less than  $3/16$  inch, and the smaller of steel, to withstand prolonged wear. Constant lubrication is needed, and to this end the cover should make an oil-tight fit with the casing, so that the bottom of the big pinion may run in oil. To prevent overfilling, make a plug-hole at the limit level, and fit a draw-off cock in the bottom of the cover. If oil ducts are bored in the bearing inside the cover, the

splashed oil will lubricate the big pinion spindle automatically.

**General** -- The sides of the casing are held against

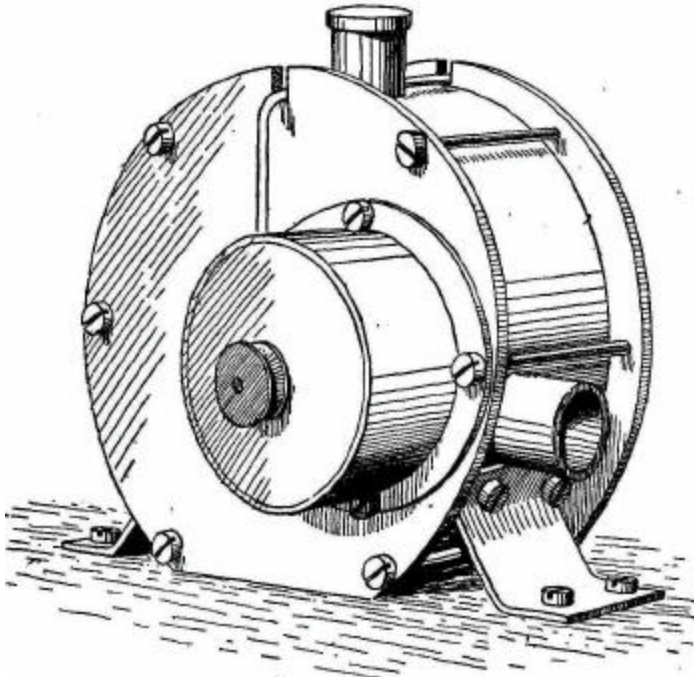

FIG. 72. -- Perspective view of completed turbine.

FIG. 73. -- Perspective view of completed turbine.

the drum by six screw bolts on the outside of the drum. The bottom of the sides is flattened as shown (Fig. 70), and the supports, S1 S2, made of such a

length that when they are screwed down the flattened part is pressed hard against the bed. The *oil box* on top of the casing has a pad of cotton wool at the bottom to regulate the flow of oil to the bearings. Fit a *drain pipe* to the bottom of the wheel-case.

**Testing.** -- If your boiler will make steam above its working pressure faster than the turbine can use it, the nozzle may be enlarged with a broach until it passes all the steam that can be raised; or a second nozzle may be fitted on the other end of the diameter on which the first lies. This second nozzle should have a separate valve, so that it can be shut off.

## XVII STEAM TOPS.

A very interesting and novel application of the steam turbine principle is to substitute for a wheel running in fixed bearings a "free" wheel pivoted on a vertical spindle, the point of which takes the weight, so that the turbine becomes a top which can be kept spinning as long as the steam supply lasts.

These toys, for such they must be considered, are very easy to make, and are "warranted to give satisfaction" if the following instructions are carried out.

**A Small Top.** -- Fig. 74 shows a small specimen, which is of the self-contained order, the boiler serving as support for the top.

For the boiler use a piece of brass tubing 4 inches or so in diameter and 3 inches long. (The case of an old brass "drum" clock, which may be bought for a few pence at a watchmaker's, serves very well if the small screw holes are soldered over.) The ends

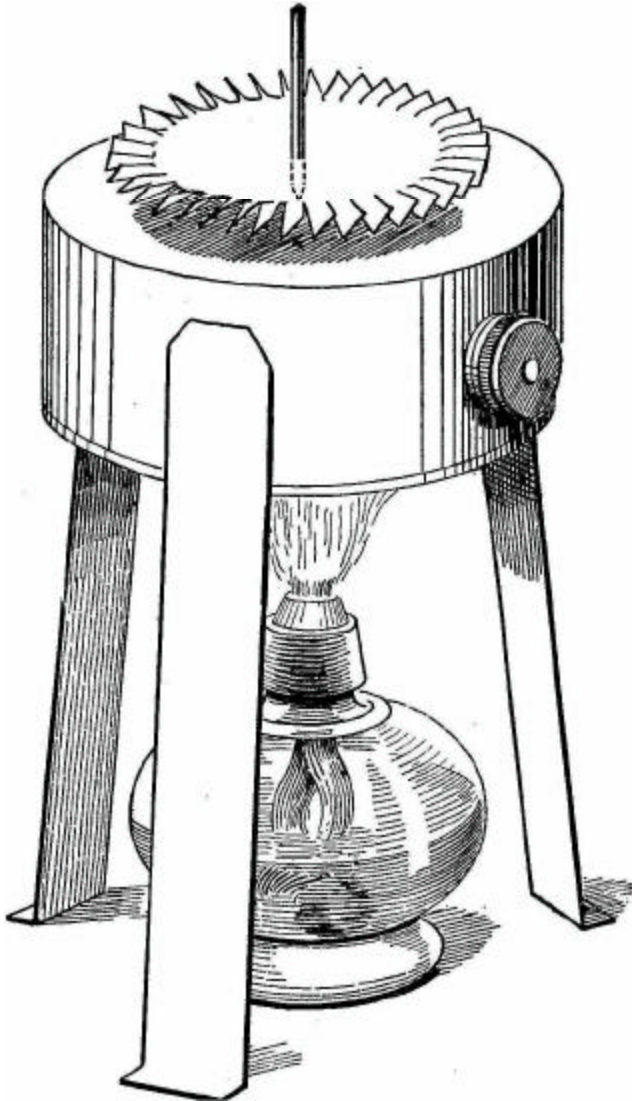

FIG. 74.-Simplest form of steam top. [1]

[Footnote 1: Spirit lamp shown for heating boiler.]

should be of brass or zinc, the one which will be uppermost being at least 1/16 inch thick. If you do not possess a lathe, lay the tube on the sheet metal, and with a *very* sharp steel point scratch round the angle between tube and plate on the inside. Cut out with cold chisel or shears to within 1/16 inch of the mark, and finish off carefully - testing by the tube now and then -- to the mark. Make a dent with a centre punch in the centre of the top plate for the top to spin in.

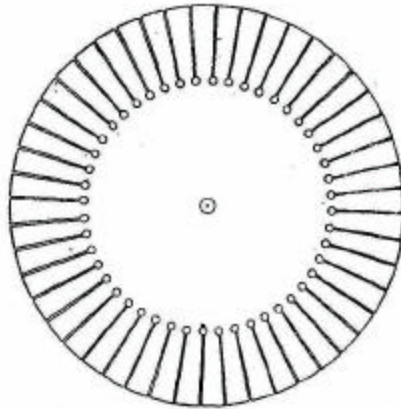

FIG. 75.—Wheel of steam top, ready for blades to be bent. A hole is drilled at the inner end of every slit to make bending easier.

FIG. 75. -- Wheel of steam top, ready for blades to be bent. A hole is drilled at the inner end of every slit to make bending easier.

Solder the plates into the tube, allowing an overlap of a quarter of an inch beyond the lower one, to help retain the heat.

The top wheel is cut out of a *flat* piece of sheet iron, zinc, or brass. Its diameter should be about 2-1/2 inches, the vanes 1/2 inch long and 1/4 inch wide at the circumference. Turn them over to make an angle of



about 45 degrees with the spindle. They will be more easily bent and give better results if holes are drilled, as shown in Fig. 75.

The spindle is made out of a bit of steel or wire -- a knitting-needle or wire-nail -- not more than 1 inch in diameter and 1-1/2 inches long. The hole for this must be drilled quite centrally in the wheel; otherwise the top will be badly balanced, and vibrate at high speeds. For the same reason, the spindle requires to be accurately pointed.

The steam ports are next drilled in the top of the boiler. Three of them should be equally spaced (120 degrees apart) on a circle of 1-inch radius drawn about the spindle poppet as centre. The holes must be as small as possible -- 1/40 to 1/50 inch -- and inclined at an angle of not more than 45 degrees to the top plate. The best drills for the purpose are tiny Morse twists, sold at from 2d. to 3d. each, held in a pin vice rotated by the fingers. The points for drilling should be marked with a punch, to give the drills a hold. Commence drilling almost vertically, and as the drill enters tilt it gradually over till the correct angle is attained.

If a little extra trouble is not objected to, a better job will be made of this operation if three little bits of brass, filed to a triangular section (Fig. 76 *a*), are

soldered to the top plate at the proper places, so that the drilling can be done squarely to one face and a perfectly clear hole obtained. The one drawback to these additions is that the vanes of the turbine may strike them. As an alternative, patches may be soldered to the under side of the plate (Fig. 76, *b*) before it is joined to the barrel; this will give longer holes and a truer direction to the steam ports.

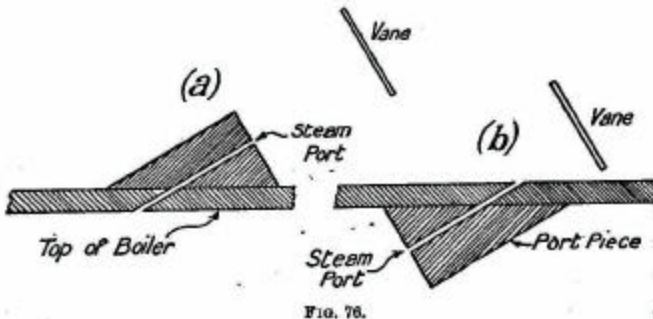

FIG. 76.

FIG. 76.

Note that it is important that the ports should be all of the same diameter and tangential to the circle on which they are placed, and all equally inclined to the plate. Differences in size or direction affect the running of the top.

Solder the spindle to the wheel in such a position that the vanes clear the boiler by an eighth of an inch or so. If tests show that the top runs quite

vertically, the distance might be reduced to half, as the smaller it is the more effect will the steam jets have.

A small brass filler should be affixed to the boiler halfway up. A filler with ground joints costs about 6d.

A wick spirit lamp will serve to raise steam. Solder to the boiler three legs of such a length as to give an inch clearance between the lamp wick and the boiler. If the wick is arranged to turn up and down, the speed of the top can be regulated.

**A Large Top** -- The top just described must be light, as the steam driving it is low-pressure, having free egress from the boiler, and small, as the steam has comparatively low velocity. The possessor of a high-pressure boiler may be inclined to make something rather more ambitious -- larger, heavier, and useful for displaying spectrum discs, etc.

The top shown in Fig. 77 is 3 inches in diameter, weighs 1 oz., and was cut out of sheet-zinc. It stands on a brass disc, round the circumference of which is soldered a ring of 5/32-inch copper tubing, furnished with a union for connection with a boiler.

The copper tubing must be well annealed, so as to bend quite easily. Bevel off one end, and solder this

to the plate. Bend a couple of inches to the curve of the plate, clamp it in position, and solder; and so on until the circle is completed, bringing the tube

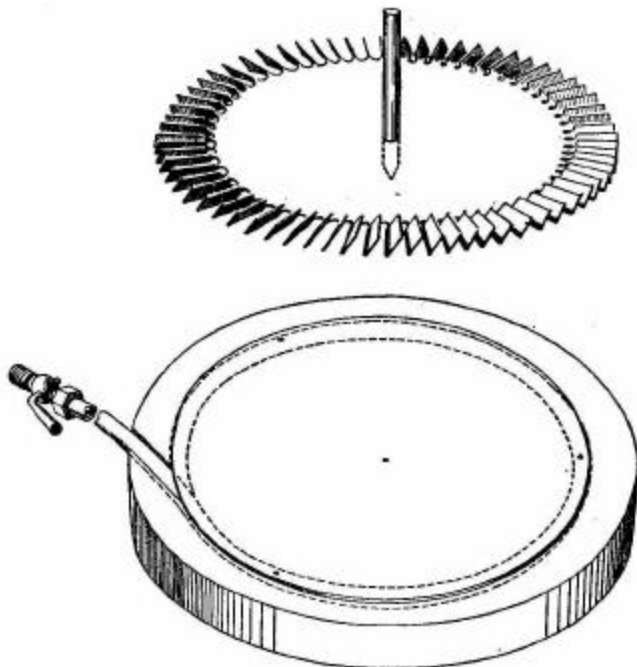

FIG. 77.—Large steam top and base.

FIG. 77. --- Large steam top and base.

snugly against the bevelled end. A hole should now be drilled through the tube into this end -- so that steam may enter the ring in both directions-and plugged externally.

By preference, the ring should be below the plate, as this gives a greater thickness of metal for drilling, and also makes it easy to jacket the tube by sinking the plate into a wooden disc of somewhat greater diameter.

Under 50 lbs. of steam, a top of this kind attains a tremendous velocity. Also, it flings the condensed steam about so indiscriminately that a ring of zinc 3 inches high and 18 inches in diameter should be made wherewith to surround it while it is running.

If a little bowl with edges turned over be accurately centred on the wheel, a demonstration of the effects of centrifugal force may be made with water, quicksilver, or shot, which fly up into the rim and disappear as the top attains high speed, and come into sight again when its velocity decreases to a certain figure. A perforated metal globe threaded on the spindle gives the familiar humming sound.

A spectrum disc of the seven primary colours -- violet, indigo, blue, green, yellow, orange, red -- revolved by the top, will appear more or less white, the purity of which depends on the accuracy of the tints used.

### XVIII. MODEL BOILERS.

A chapter devoted to the construction of model boilers may well open with a few cautionary words, as the dangers connected with steam-raisers are very real; and though model-boiler explosions are fortunately rare, if they do occur they may be extremely disastrous. Therefore the following warnings: --

- (1.) Do not use tins or thin sheet iron for boilers. One cannot tell how far internal corrosion has gone. The scaling of 1/100 inch of metal off a "tin" is obviously vastly more serious than the same diminution in the thickness of, say, a 1/4-inch plate. Brass and copper are the metals to employ, as they do not deteriorate at all provided a proper water supply be maintained.
- (2.) If in doubt, make the boiler much more solid than is needed, rather than run any risks.
- (3.) Fit a *steam gauge*, so that you may know what is happening.
- (4.) *Test* your boiler under steam, and don't work it at more than half the pressure to which it has been tested. (See p. 220.)

In the present chapter we will assume that the barrels of all the boilers described are made out of solid-drawn seamless copper tubing, which can be bought in all diameters up to 6 inches, and of any one of several thicknesses. Brass tubing is more easily soldered, but not so good to braze, and generally not so strong as copper, other things being equal. Solid-drawn tubing is more expensive than welded tubing or an equivalent amount of sheet metal, but is considerably stronger than the best riveted tube.

**Boiler ends** may be purchased ready turned to size.

Get stampings rather than castings, as the first are more homogeneous, and therefore can be somewhat lighter.

**Flanging Boiler Ends.** -- To make a good job, a plate for an end should be screwed to a circular block of hard wood (oak or boxwood), having an outside diameter less than the inside diameter of the boiler barrel by twice the thickness of the metal of the end, and a rounded-off edge. The plate must be annealed by being heated to a dull red and dipped in cold

water. The process must be repeated should the hammering make the copper stubborn.

**Stays** should be used liberally, and be screwed and nuted at the ends. As the cutting of the screw thread reduces the effective diameter, the strength of a stay is only that of the section at the *bottom* of the threads.

**Riveting**. -- Though stays will prevent the ends of the boiler blowing off, it is very advisable to rivet them through the flanges to the ends of the barrel, as this gives mutual support independently of soldering or brazing. Proper boiler rivets should be procured, and annealed before use. Make the rivet holes a good fit, and drill the two parts to be held together in one operation, to ensure the holes being in line. Rivets will not close properly if *too long*. Dies for closing the rivet heads may be bought for a few pence.

**Soldering, etc.** -- Joints not exposed directly to the furnace flames may be soldered with a solder melting not below 350 degrees Fahr. Surfaces to be riveted together should be "tinned" before riveting, to ensure the solder getting a good hold afterwards. The solder should be sweated right through the joint with a blow-lamp to make a satisfactory job.



All joints exposed to the flames should be *silver-soldered*, and other joints as well if the working pressure is to exceed 50 lbs. to the square inch. Silver-soldering requires the use of a powerful blow-lamp or gas-jet; ordinary soft soldering bits and temperatures are ineffective. *Brazing* is better still, but should be done by an expert, who may be relied on not to burn the metal. It is somewhat risky to braze brass, which melts at a temperature not far above that required to fuse the spelter (brass solder). Getting the prepared parts of a boiler silver-soldered or brazed together is inexpensive, and is worth the money asked.

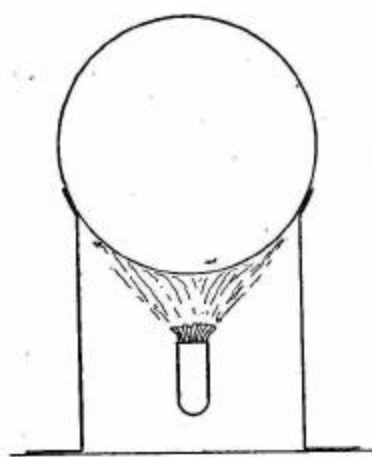

FIG. 78.

FIG. 78.

### Some Points in Design.

The *efficiency* of a boiler is governed chiefly (1) by the amount of heating surface exposed to the flames; (2) by the distribution of the heating surface; (3) by

the amount of fuel which can be burnt in the furnace in a given time; (4) by avoiding wastage of heat.

The simplest form of boiler, depicted in Fig. 78, is extremely inefficient because of its small heating surface. A great deal of the heat escapes round the sides and the ends of the boiler. Moreover, a good deal of the heat which passes into the water is radiated out again, as the boiler is exposed directly to the air.

Fig. 79 shows a great improvement in design. The boiler is entirely enclosed, except at one end, so that the hot gases get right round the barrel, and the effective heating surface has been more than doubled by fitting a number of water-tubes, *aaa*, *bbbb*, which lie right in the flames, and absorb much heat which would otherwise escape. The tubes slope upwards from the chimney end, where the heat is less, to the fire-door end, where the heat is fiercer, and a good circulation is thus assured. The Babcock and Wilcox boiler is the highest development of this system, which has proved very successful, and may be recommended for model boilers of all sizes. The heating surface may be increased indefinitely by multiplying the number of tubes. If a solid fuel-coal, coke, charcoal, etc.-fire is used,

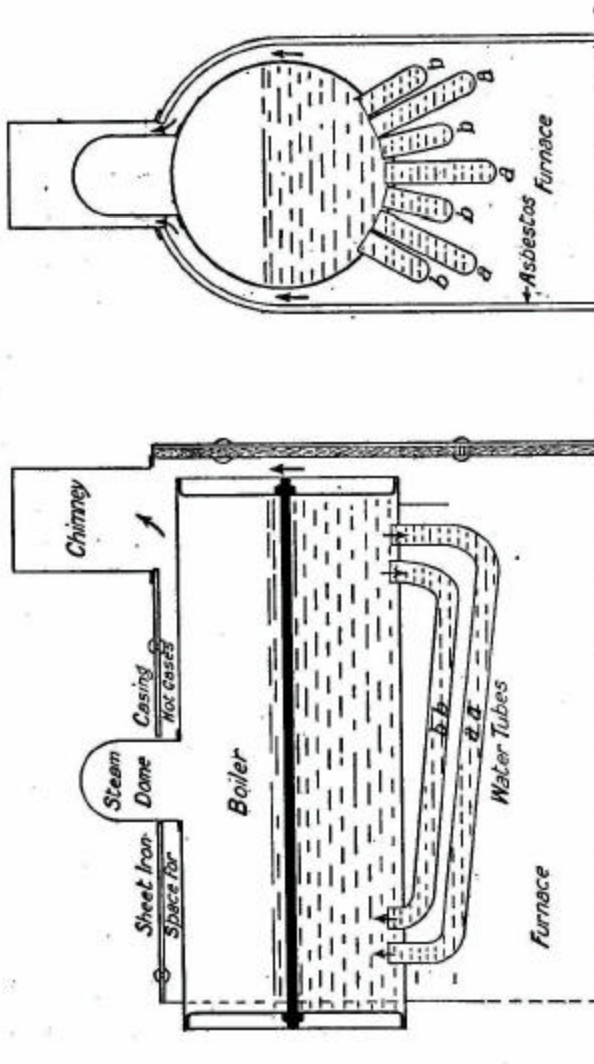

FIG. 79.—Side and end elevations of small water-tube boiler.

FIG. 79 -- Side and end elevations of a small water-tube boiler.

the walls of the casing should be lined with asbestos or fire-clay to prevent the metal being burnt away.

The horizontal boiler has an advantage over the vertical in that, for an equal diameter of barrel, it affords a larger water surface, and is, therefore, less subject to "priming," which means the passing off of minute globules of water with the steam. This trouble, very likely to occur if the boiler has to run an engine too large for it, means a great loss of efficiency, but it may be partly cured by making the steam pass through coils exposed to the furnace gases on its way to the engine. This "superheating" evaporates the globules and dries the steam, besides raising its temperature. The small water-tube is preferable to the small fire-tube connecting furnace and chimney, as its surface is exposed more directly to the flames; also it increases, instead of decreasing, the total volume of water in the boiler.

#### **A Vertical Boiler.**

The vertical boiler illustrated by Fig. 80 is easily made. The absence of a water jacket to the furnace is partly compensated by fitting six water-tubes in the bottom. As shown, the barrel is 8 inches long

and 6 inches in outside diameter, and the central flue 1-1/2 inches across outside solid-drawn 1/16-inch

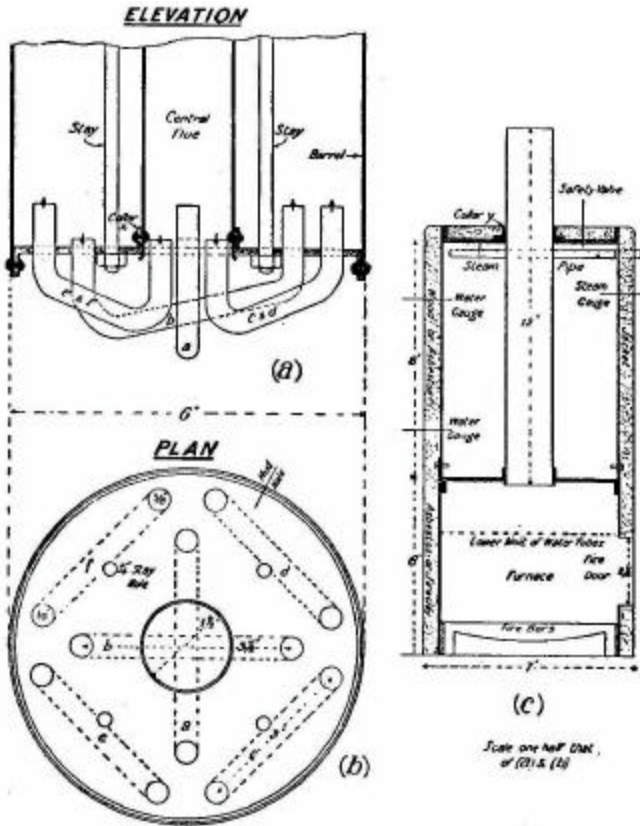

FIG. 80.—Details of vertical boiler.

FIG. 80. -- Details of vertical boiler.

tubing, flanged ends, and four 1/4-inch stays--disposed as indicated in Fig. 80 (a) and (b)--are used. The

5/16 or 3/8 inch water-tubes must be annealed and filled with lead or resin before being bent round wooden templates. After bending, run the resin or lead out by heating. The outflow end of each pipe should project half an inch or so further through the boiler bottom than the inflow end.

Mark out and drill the tube holes in the bottom, and then the flue hole, for which a series of small holes must be made close together inside the circumference and united with a fret saw. Work the hole out carefully till the flue, which should be slightly tapered at the end, can be driven through an eighth of an inch or so. The flue hole in the top should be made a good fit, full size.

Rivet a collar, *x* (Fig. 80, *a*), of strip brass 1/4 inch above the bottom of the flue to form a shoulder. Another collar, *y* (Fig. 80, *c*), is needed for the flue above the top plate. Put the ends and flue temporarily in place, mark off the position of *y*, and drill half a dozen 5/32-inch screw holes through *y* and the flue. Also drill screw holes to hold the collar to the boiler top.

The steam-pipe is a circle of 5/16-inch copper tube, having one end closed, and a number of small holes bored in the upper side to collect the steam from

many points at once. The other end is carried through the side of the boiler.

**Assembling.** -- The order of assembling is: -- Rivet

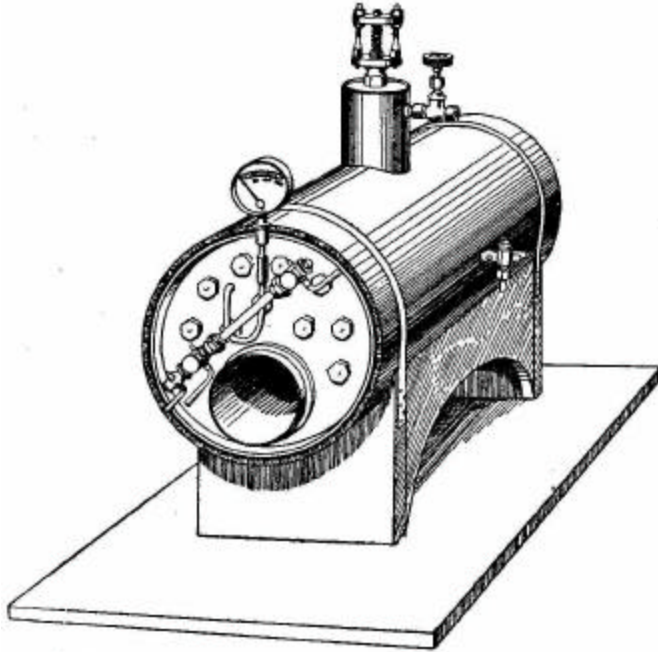

FIG. 81.—Perspective view of horizontal boiler mounted on wooden base.

FIG. 81. -- Perspective view of horizontal boiler mounted on wooden base.

in the bottom; put the steam-pipe in place; rivet in the top; insert the flue, and screw collar *y* to the top; expand the bottom of the flue by hammering so that it cannot be withdrawn; insert the stays and

screw them up tight; silver-solder both ends of the flue, the bottom ends of the stays, and the joint between bottom and barrel. The water-tubes are then inserted and silver-soldered, and one finishes by soft-soldering the boiler top to the barrel and fixing in the seatings for the water and steam gauges, safety-valve, mud-hole, filler, and pump-if the last is fitted.

The furnace is lined with a strip of stout sheet iron, 7 inches wide and 19-1/4 inches long, bent round the barrel, which it overlaps for an inch and a half. Several screws hold lining and barrel together. To promote efficiency, the furnace and boiler is jacketed with asbestos -- or fire-clay round the furnace -- secured by a thin outer cover. The enclosing is a somewhat troublesome business, but results in much better steaming power, especially in cold weather. Air-holes must be cut round the bottom of the lining to give good ventilation.

A boiler of this size will keep a 1 by 1-1/2 inch cylinder well supplied with steam at from 30 to 40 lbs. per square inch.

### **A Horizontal Boiler.**

The boiler illustrated by Fig. 81 is designed for heating with a large paraffin or petrol blow-lamp.



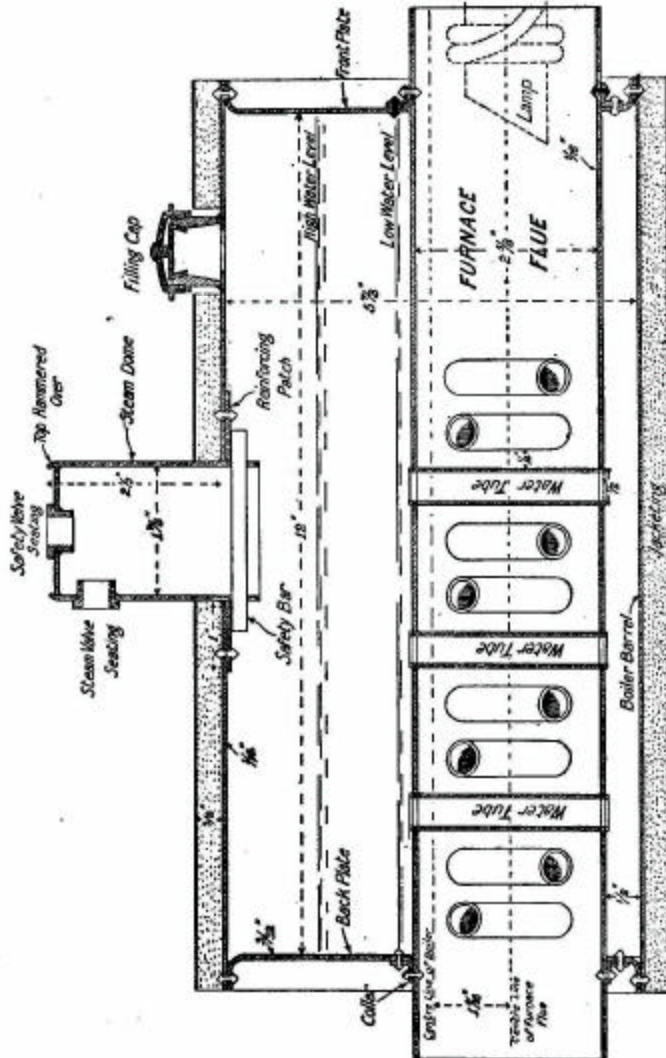

FIG. 82.—Longitudinal section of large water-tube boiler.

FIG. 82. -- Longitudinal section of large water-tube boiler

It has considerably greater water capacity, heating surface --the furnace being entirely enclosed -- and water surface than the boiler just described. The last at high-water level is about 60, and at low-water level 70, square inches.

The vertical section (Fig. 82) shows 1/16-inch barrel, 13 inches long over all and 12 inches long between the end plates, and 6 inches in diameter. The furnace flue is 2-1/2 inches across outside, and contains eleven 1/2-inch cross tubes, set as indicated by the end view (Fig. 83), and 3/4 inch apart, centre to centre. This arrangement gives a total heating surface of about 140 square inches. If somewhat smaller tubes are used and doubled (see Fig. 84), or even trebled, the heating surface may be increased to 180-200 square inches. With a powerful blow-lamp this boiler raises a lot of steam.

**Tubing the Furnace Flue.** -- Before any of the holes are made, the lines on which the centres lie must be scored from end to end of the flue on the outside. The positions of these lines are quickly found as follows: -- Cut out a strip of paper exactly as long as the circumference of the tube, and plot the centre lines on it. The paper is then applied to the tube again, and poppet marks made with a centre punch

opposite to or through the marks on the paper. Drive a wire-nail through a piece of square wood and sharpen the point. Lay the flue on a flat surface,

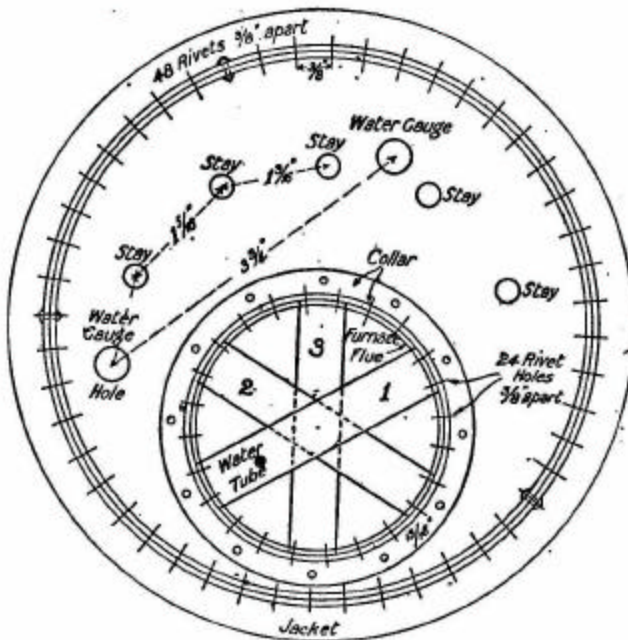

FIG. 83.—End of horizontal boiler, showing position of holes for stays and fittings.

FIG. 83.—End of horizontal boiler, showing position of holes for stays and fittings.

apply the end of the nail to one of the poppet marks, and draw it along the flue, which must be held quite firmly. When all the lines have been scored, the centring of the water tubes is a very easy matter.

The two holes for any one tube should be bored independently, with a drill somewhat smaller than the tube, and be opened to a good fit with a reamer or broach passed through both holes to ensure their sides being in line. Taper the tubes -- 2-7/8 inches long each -- slightly at one end, and make one of the holes a bit smaller than the other. The tapered end is passed first through the larger hole and driven home in the other, but not so violently as to distort the flue. If the tubes are made fast in this way, the subsequent silver-soldering will be all the easier.

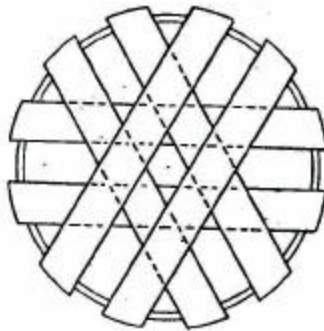

FIG. 84.—Doubled cross tubes in horizontal boiler flue.

FIG. 84. -- Doubled cross tubes In horizontal boiler flue.

**The Steam Dome.** -- The large holes -- 2 inches in diameter -- required for the steam dome render it necessary to strengthen the barrel at this point. Cut out a circular plate of metal 4 inches across, make a central hole of the size of the steam dome, and bend the plate to the curve of the inside of the barrel. Tin the contact faces of the barrel and "patch" and draw them together with screws or

rivets spaced as shown in Fig. 85, and sweat solder into the joint. To make it impossible for the steam dome to blowout, let it extend half an inch through the barrel, and pass a piece of 1/4-inch brass rod through it in contact with the barrel. The joint is secured with hard solder. Solder the top of the dome in 1/8 inch below the end of the tube, and burr the end over. The joint should be run again afterwards to ensure its being tight.

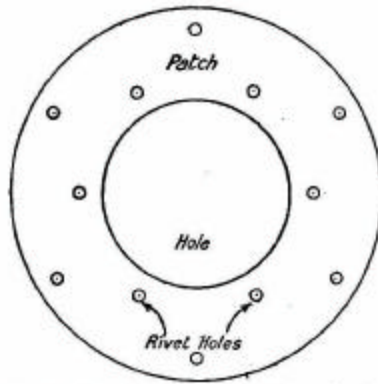

FIG. 85.—Showing how to mark out strengthening patch round steam dome hole.

FIG. 85. -- Showing how to mark out strengthening patch round steam dome hole

The positions of stays and gauges is shown in Fig. 83.

**Chimney.** -- This should be an elbow of iron piping fitting the inside of the flue closely, made up of a 9-inch and a 4-inch part. The last slips into the end of the flue; the first may contain a coil for superheating the steam.

**A Multitubular Boiler.**

Figs. 86 and 87 are respectively end and side elevations of a multitubular boiler having over 600

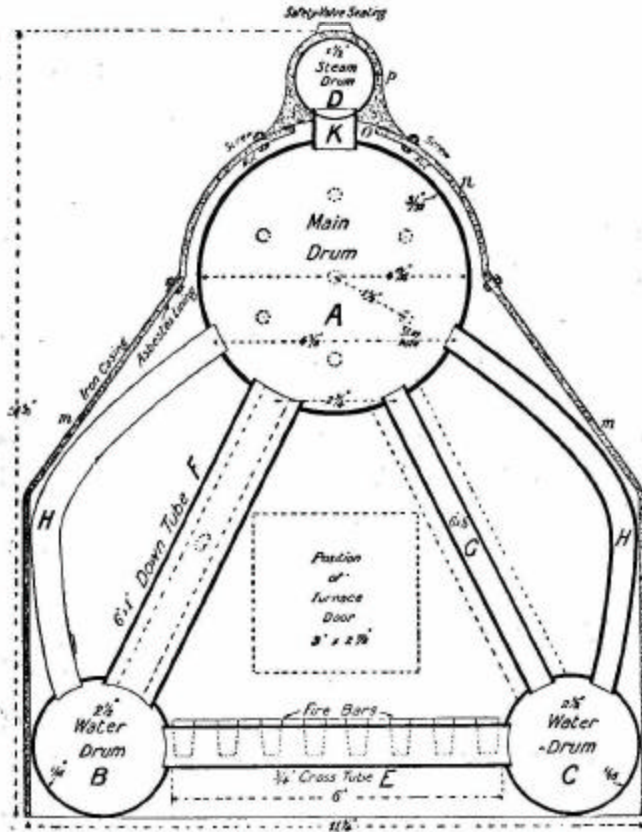

FIG. 86. -- Cross section of multitubular boiler.

FIG. 86. -- Cross section of multitubular boiler.

square inches of heating surface -- most of it contributed by the tubes -- and intended for firing with solid fuel.

The boiler has a main water-drum, A, 5 inches in diameter and 18 inches long, and two smaller water-drums, B and C, 2-1/2 by 18 inches, connected by two series of tubes, G and H, each set comprising 20 tubes. The H tubes are not exposed to the fire so directly as the G tubes, but as they enter the main drum at a higher point, the circulation is improved by uniting A to B and C at both ends by large 1-inch drawn tubes, F. In addition, B and C are connected by three 3/4-inch cross tubes, E, which prevent the small drums spreading, and further equalize the water supply. A 1-1/2-inch drum, D, is placed on the top of A to collect the steam at a good distance from the water.

**Materials.** -- In addition to 1-1/2 feet of 5 by 3/32 inch solid-drawn tubing for the main, and 3 feet of 2-1/2 by 1/16 inch tubing for the lower drums, the boiler proper requires 22-1/2 feet of 1/2-inch tubing, 19 inches of 3/4-inch tubing, 2-1/4 feet of 1-inch tubing, 1 foot of 1-1/2-inch tubing, and ends of suitable size for the four drums.

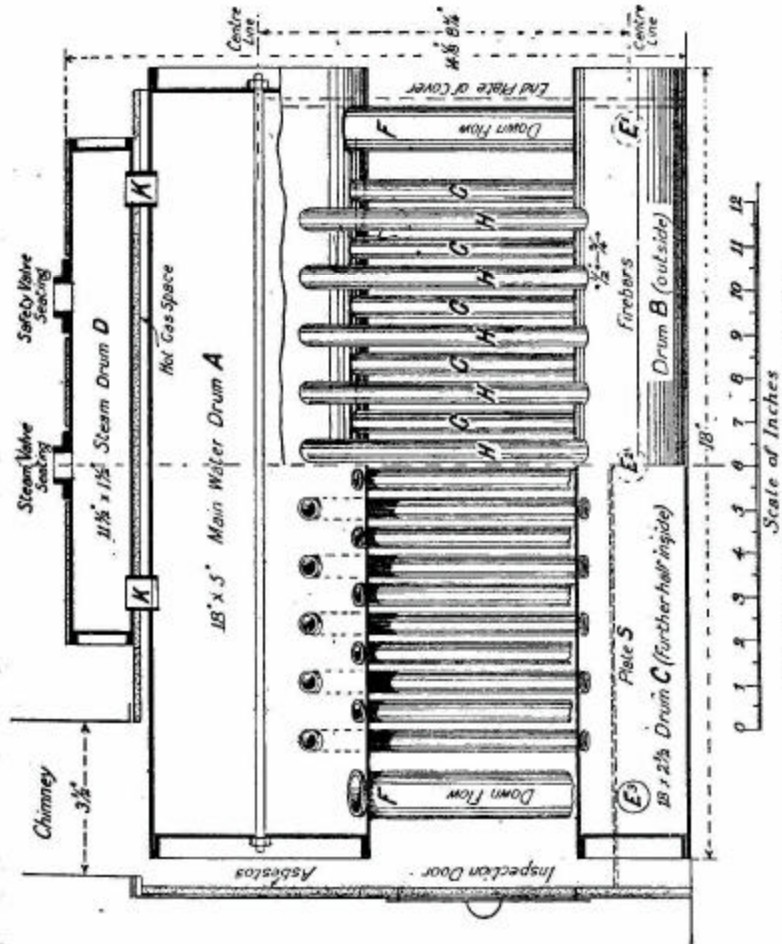

FIG. 87. -- Longitudinal section of multitubular boiler

FIG. 87.—Longitudinal section of multitubular boiler.



**CONSTRUCTION.**

The centres for the water-tubes, G and H, should be laid out, in accordance with Fig. 88, on the tops of B and C and the lower part of A, along lines scribed in the manner explained on p. 207. Tubes H must be bent to a template to get them all of the

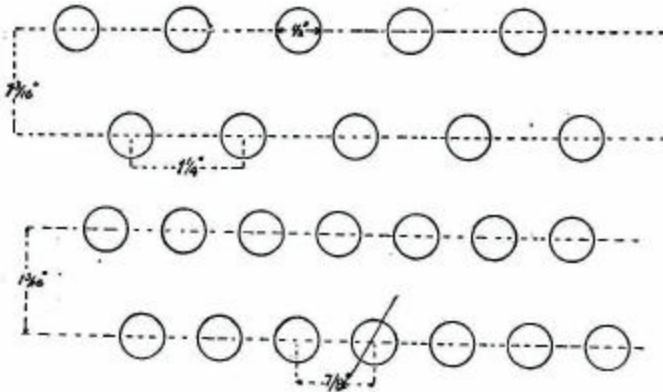

FIG. 88.—Two arrangements for tube holes in multitubular boiler.

FIG. 88.-Two arrangements for tube holes in multi tubular boiler.

same shape and length, and all the tubes be prepared before any are put in place. If the tubes are set  $\frac{7}{8}$  inch apart, centre to centre, instead of  $1\frac{1}{4}$  inches, the heating surface will be greatly increased and the furnace casing better protected.

**Assembling.** -- When all necessary holes have been made and are of the correct size, begin by riveting and silver-soldering in the ends of the drums. Next

fix the cross tubes, E, taking care that they and B and C form rectangles. Then slip the F, G, and H tubes half an inch into the main drum, and support A, by means of strips passed between the G and H tubes, in its correct position relatively to B and C. The E tubes can now be pushed into B and C and silver-soldered. The supports may then be removed, and the a and H tubes be got into position and secured. Drum D then demands attention. The connecting tubes, KK, should be silver-soldered in, as the boiler, if properly made, can be worked at pressures up to 100 lbs. per square inch.

The casing is of 1/20-inch sheet iron, and in five parts. The back end must be holed to allow A, B, and C to project 1 inch, and have a furnace-door opening, and an airway at the bottom, 5 inches wide and 1 inch deep, cut in it. The airway may be provided with a flap, to assist in damping down the fire if too much steam is being raised. In the front end make an inspection opening to facilitate cleaning the tubes and removing cinders, etc.

The side plates, *m m*, are bent as shown in Fig. 86, and bolted to a semicircular top plate, *n*, bent to a radius of 6 inches. A slot, 1-1/2 inches wide and 11-1/2 inches long, must be cut in the top, *n*, to allow it to

be passed over drum D; and there must also be a 3 or 3-1/2 inch hole for the chimney. A plate, *p*, covers in D. A little plate, *o*, is slipped over the slot in *n*, and asbestos is packed in all round D. The interior of the end, side, and the top plates should be lined with sheet asbestos held on by large tin washers and screw bolts. To protect the asbestos, movable iron sheets may be interposed on the furnace side. These are replaced easily if burnt away. The pieces *m m* are bent out at the bottom, and screwed down to a base-plate extending the whole length of the boiler.

The fire-bars fill the rectangle formed by the tubes B, E1, and E2. A plate extends from the top of E2 to the front plate of the casing, to prevent the furnace draught being "short circuited."

### **Boiler Fittings.**

**Safety Valves.** -- The best all-round type is that shown in Fig. 89. There is no danger of the setting being accidentally altered, as is very possible with a lever and sliding weight. The valve should be set by the steam gauge. Screw it down, and raise steam to the point at which you wish the safety valve to act, and then slacken off the regulating nuts

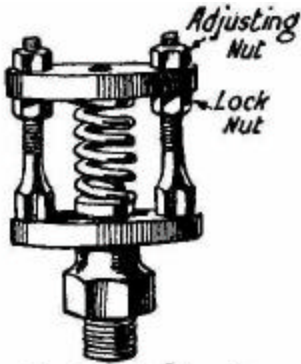

FIG. 89.—Safety valve.

until steam issues freely. The lock nuts under the cross-bar should then be tightened up. In the case of a boiler with a large heating surface, which makes steam quickly, it is important that the safety-valve should be large enough to master the steam. If the valve is too small, the pressure may rise to a dangerous height, even with the steam coming out as fast as the valve can pass it.

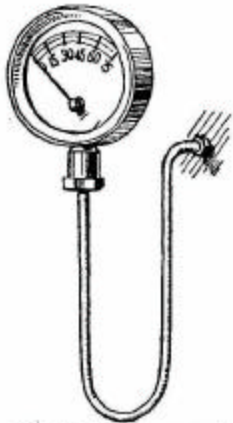

FIG. 90.—Steam gauge and siphon.

FIG. 90.-Steam gauge and siphon.

**Steam Gauges.** -- The steam gauge should register pressures considerably higher than that to be used, so that there may be no danger of the boiler being forced unwittingly beyond the limit registered. A siphon piece should be interposed between boiler and gauge (Fig. 90), to protect the latter from the direct action of the steam. Water condenses in the siphon, and does not become very hot.



FIG. 91.--Water gauge.

FIG. 91.-Water gauge.

**Water Gauges** should have three taps (Fig. 91), two between glass and boiler, to cut off the water if the glass should burst, and one for blowing off through. Very small gauges are a mistake, as the water jumps about in a small tube. When fitting a gauge, put packings between the bushes and the glass-holders, substitute a piece of metal rod for the glass tube, and pack the rod tightly. If the bushes are now sweated into the boiler end while thus directed, the gauge must be in line for the glass. This method is advisable in all cases, and is necessary if the boiler end is not perfectly flat.

**Pumps** . -- Where a pump is used, the supply should enter the boiler below low-water level through a non-return valve fitted with a tap, so that water can be prevented from blowing back through the pump. As regards the construction of pumps, the reader is referred to p. 164 and to Chapter XXII.

**Filling Caps** . - The filling cap should be large enough to take the nozzle of a good-sized funnel

with some room to spare. Beat the nozzle out of shape, to give room for the escape of the air displaced by the water.

The best form of filling cap has a self-seating ground plug, which, if properly made, is steam-tight without any packing. If needed, asbestos packing can easily be inserted between plug and cap.

**Mud-holes.** -- All but the smallest boilers should have a mud-hole and plug in the bottom at a point not directly exposed to the furnace. In Fig. 82 it is situated at the bottom of the barrel. In Figs. 86 and 87 there should be a mud-hole in one end of each of the three drums, A, B, and C. The plug may be bored at the centre for a blow-off cock, through which the boiler should be emptied after use, while steam is up, and after the fire has been "drawn." Emptying in this way is much quicker than when there is no pressure, and it assists to keep the boiler free from sediment.



FIG. 92.—Steam cock.

FIG. 92. -Steam cock.

**Steam Cocks.**-The screw-down type (Fig. 92) is very preferable to the "plug" type, which is apt to leak and stick.

**Testing Boilers.** -- The tightness of the joints of a boiler is best tested in the first instance by means of compressed air. Solder on an *all-metal* cycle valve, "inflate" the boiler to a considerable pressure, and submerge it in a tub of water. The slightest leak will be betrayed by a string of bubbles coming

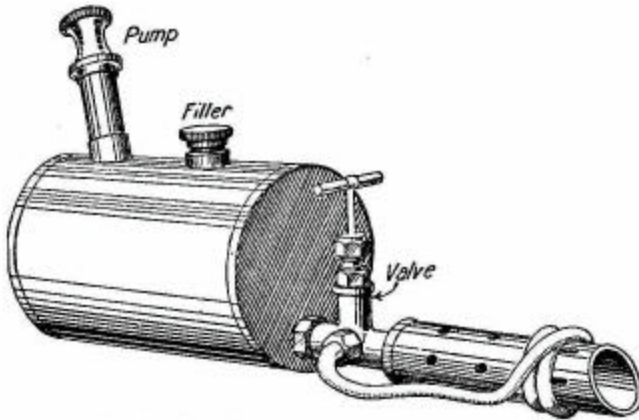

FIG. 94.—Benzoline lamp for model central-flue boiler.

FIG. 94. -- Benzoline lamp for model central-flue boiler.

directly from the point of leakage. Mark any leaks by plain scratches, solder them up, and test again.

The boiler should then be quite filled with cold water, and heated gradually until the pressure gauge has risen to over the working pressure. There is no risk of an explosion, as the volume of the water is increased but slightly.

The third test is the most important and most

risky of all-namely, that conducted under steam to a pressure well above the working pressure.

In order to carry out the test without risk, one needs to be able to watch the steam-gauge from a considerable distance, and to have the fire under control. My own method is to set the boiler out in the open, screw down the safety-valve so that it cannot lift, and raise steam with the help of a blow-lamp, to which a string is attached wherewith to pull it backwards along a board. If the boiler is to be worked at 50 lbs., I watch the steam gauge through a telescope until 100 lbs. is recorded, then draw the lamp away. After passing the test, the boiler, when pressure has fallen, say, 20 lbs., may safely be inspected at close quarters for leaks.

This test is the only quite satisfactory one, as it includes the influence of high temperature, which has effects on the metal not shown by "cold" tests, such as the hydraulic.

*Do not increase* your working pressure without first re-testing the boiler to double the new pressure to be used.

**Fuels.** -- For very small stationary boilers the methylated spirit lamp is best suited, as it is smell-less, and safe if the reservoir be kept well apart from



the burner and the supply is controllable by a tap or valve. (See Fig. 104.)

For medium-sized model boilers, and for small launch boilers, benzoline or petrol blow-lamps and paraffin stoves have become very popular, as they do away with stoking, and the amount of heat is easily regulated by governing the fuel supply. Fig. 94 is a sketch of a blow-lamp suitable for the horizontal boiler shown on pp. 204, and 206, while Fig.

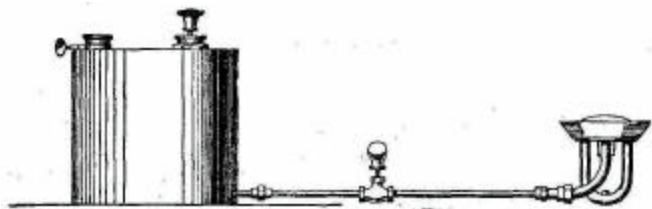

FIG. 95.—Paraffin burner for vertical boiler.

FIG. 95.-Paraffin burner for vertical boiler.

95 shows a convenient form of paraffin stove with silent "Primus" burner, which may be used for a horizontal with considerable furnace space or for vertical boilers. In the case of all these liquid fuel consumers, the amount of heat developed can be increased by augmenting the number of burners. Where a gas supply is available its use is to be recommended for small stationary boilers.

**Solid Fuels.** -- The chief disadvantages attaching to

these are smoke and fumes; but as a solid fuel gives better results than liquid in a large furnace, it is preferred under certain conditions, one of them being that steam is not raised in a living room. Charcoal, coke, anthracite coal, and ordinary coal partly burned are the fuels to use, the fire being started with a liberal supply of embers from an open fire. Every solid-fuel boiler should have a steam-blower in the chimney for drawing up the fire; and if a really fierce blaze is aimed at, the exhaust from the engine should be utilized for the same purpose.

[Transcriber's note: Do not use lead solder on articles associated with human or animal consumption.]

### **QUICK BOILING KETTLES.**

The principles of increasing the area of heating surface in model boilers may be applied very practically to the common kettle.

The quick-boiling kettle is useful for camping out, for heating the morning tea water of the very early riser, and for the study "brew," which sometimes has to be made in a hurry; and, on occasion, it will be so welcome in the kitchen as to constitute a very useful present to the mistress of the house.

As the putting in of the tubes entails some trouble, it is worth while to select a *good* kettle for treatment. Get one that is made of *thick* tinned sheet iron (cast-iron articles are unsuitable), or even of copper, if you are intent on making a handsome gift which will last indefinitely. The broad shallow kettle is best suited for tubing, as it naturally has a fair heating surface, and its bottom area gives

room for inserting plenty of tubes. Also, the tubes can be of good length. Let us, therefore, assume that the kettle will be of at least 8 inches diameter.

In Figs. 96 (*a*) and 96 (*b*) are shown two forms of *fire-tube* kettles (*a* and *b*) and two of *water-tube* (*c* and *d*). For use over a spirit or Swedish petroleum stove the first two types are most convenient; the third will work well on a stove or an open fire; and the last proves very efficient on an open fire. One may take it that, as a general rule, areas of heating surface being equal, the water-tube kettle will boil more quickly than the fire-tube.

### **Fire-tube Kettles.**

The tubing of Figs. 96 (*a*) and 96 (*b*) presents a little difficulty in each case. The straight tube is the more difficult to insert, owing to the elliptical shape of the ends; whereas the bent tube requires only circular holes, but must be shaped on a template.

The tubing used for (*a*) should have at least 5/8-inch internal diameter, for (*b*) 1/2 inch, and be of thin copper. Hot gases will not pass willingly through tubes much smaller than this, in the absence of induced or forced draught.

For convenience in fitting, the tubes should run at an angle of 45 degrees to the bottom and side of the kettle, as this gives the same bevel at each end. Find the centre of the bottom, and through it scratch plainly four diameters 45 degrees apart. From their ends draw perpendiculars up the side of the kettle.

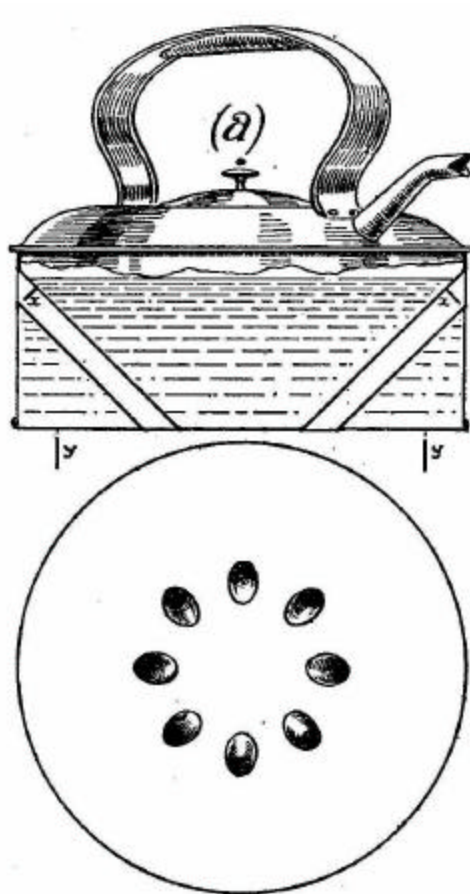

FIG. 96 (a).

FIG. 96 (a).

Now draw on a piece of paper a section of the kettle, and from what is selected as a convenient water-level run a line obliquely, at an angle of 45 degrees, from the side to the bottom. Measuring off from this diagram, you can establish the points in the side and bottom at which the upper and longer side of the tubes should emerge. Mark these off.

Next bevel off a piece of tubing to an angle of 45 degrees, cutting off roughly in the first instance and finishing up carefully with a file till the angle is exact. Solder to the end a piece of tin, and cut and file this to the precise shape of the elliptical end. Detach by heating, scribe a line along its longest axis, and attach it by a small countersunk screw to the end of a convenient handle.

Place this template in turn on each of the eight radii, its long axis in line with it, being careful that the plate is brought up to the marks mentioned above, and is on the bottom corner side of it. Scratch round plainly with a fine steel point.

To remove the metal for a tube hole, it is necessary to drill a succession of almost contiguous holes as near the scratch as possible without actually cutting it. When the ring is completed, join the holes with a cold chisel held obliquely. Then file carefully with a round file, just not cutting the scratch. As the side of the hole nearest to the bottom corner should run obliquely to enable the tube to pass, work this out with the file held at an angle.

As soon as a pair of holes (one in the bottom, the other in the side) have been made, true up the side hole until a piece of tubing will run through it at the correct angle. Then bevel off the end to 45 degrees and pass the tube through again, bringing the bevel up against the bottom hole from the inside. If it is a trifle difficult to pass, bevel off the edge slightly on the inside to make a fairly easy driving fit. (Take care not to bulge the bottom of the kettle.) Mark off the tube beyond the side hole, allowing an eighth of an inch extra. Cut at the mark, and number tube and hole, so that they may be paired correctly later on.

When all the tubes are fitted, "tin" the ends with a wash of solder before returning them to their holes. If there is a gap at any point wide enough to let the solder run through, either beat out the tube from the inside into contact, or, if this is impracticable, place a bit of brass wire in the gap. Use powdered resin by preference as flux for an iron kettle, as it does not cause the rusting produced by spirit of salt. If the latter is used, wipe over the solder with a strong ammonia or soda solution, in order to neutralize the acid.

As the hot gases may tend to escape too quickly through large tubes, it is well to insert in the upper

end of each a small "stop," *x* -- a circle of tin with an arc cut away on the bottom side. To encourage the gases to pass up the tubes instead of along the bottom, a ring of metal, *y*, may be soldered beyond the bottom holes, if an oil or spirit stove is to be used. This ring should have notches cut along the kettle edge, so as not to throttle the flame too much.

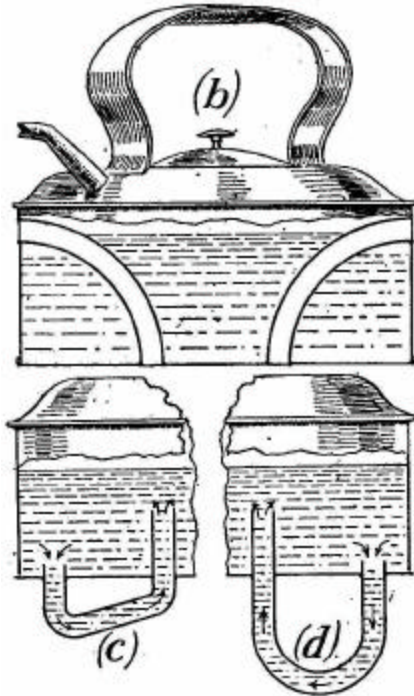

FIG. 96--(b), (c), and (d).

FIG. 96 -- (b), (c), and (d).

As the tubes for these require bending to shape in each case, the three types may be grouped together. The tubes of *c* and *d*, which require bending to somewhat sharp curves, may be of 3/8-inch internal diameter. In the last two cases the direction of the water



travel is shown. The up-flow end, which projects farther through the bottom than the down-flow, is nearer the centre, where, if a gas stove is used, the heat is more intense than at the circumference of the bottom. (*Note.*-If type *c* is for use on a three-support stove, increase the number of tubes to 9, equally spaced, 40 degrees apart, so that the kettle may be adjusted easily.)

The copper tubing should be annealed or softened by heating to a dull red and plunging in cold water. Cut a wooden template of the exact outline of the *inside* line of the shape that the tube is to assume, and secure this firmly to a board. Fill the tube with melted resin, to prevent, as much as possible, "buckling" or flattening on the curves. The tube must be kept up to the template by a stop of hard wood, at the end at which bending commences. Don't cut the tube into lengths before bending, as short pieces are more difficult to handle. When a piece sufficient for a tube has been bent, cut it oft, and remove the resin by heating.

The fitting of the tubes is an easy matter, as the holes are circular. Pair off a tube with its holes and number it. A fluted reamer will be found invaluable for enlarging them to the correct size.

Tin all tubes at points where they are to be attached to the kettle.

In Fig. 96 (*c*) and (*d*) care should be taken to make all the tubes project the same distance, so that the kettle may be level when resting on them.

## XX. A HOT-AIR ENGINE.

The pretty little toy about to be described is interesting as a practical application to power-producing purposes of the force exerted by expanding air. It is easy to make, and, for mere demonstration purposes, has an advantage over a steam-engine of the same size in that it can be set working in less than a minute, and will continue to act as long as a small spirit flame is kept burning beneath it; it cannot explode; and its construction is a simpler matter than the building of a steam-engine.

**Principles of the Hot-air Engine.** -- Fig. 97 gives a sectional view of the engine. The place of what would be the boiler in a steam-engine of similar shape is taken by an air chamber immediately above the lamp, and above that is a chamber through which cold water circulates. In what we will call the heating chamber a large piston, known as the *displacer*, is moved up and down by a rod D and a connecting rod CR1. This piston does not touch the sides of the chamber, so that the bulk of the air is

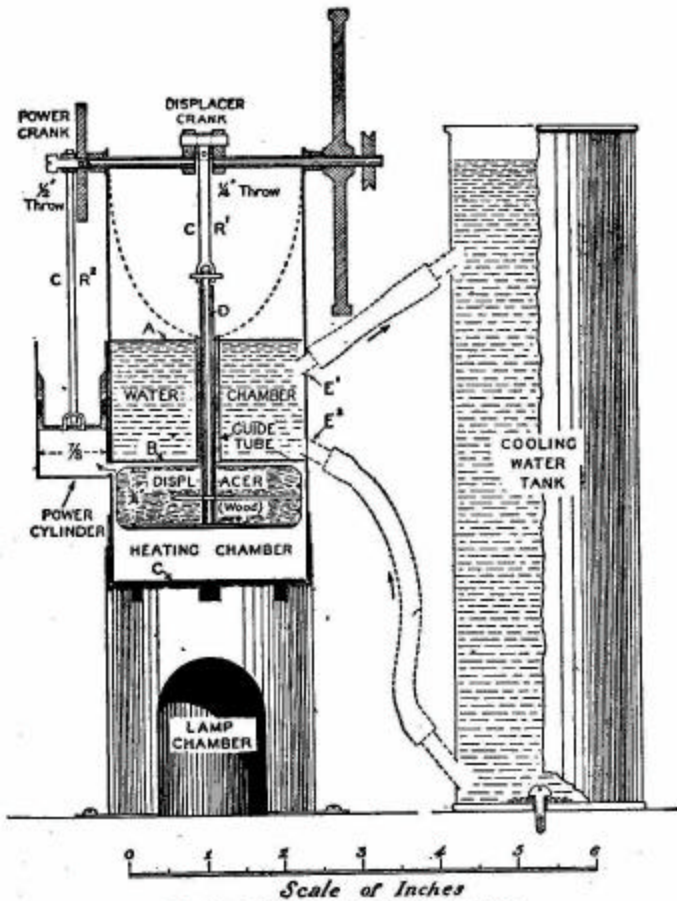

FIG. 97.—Vertical section of hot-air engine.

FIG. 97. -- Vertical section of hot-air engine.

pushed past it from one end of the chamber to the other as the piston moves. When the displacer is in the position shown -- at the top of its stroke -- the air is heated by contact with the hot plate C, and expands, forcing up the piston of the power cylinder, seen on the left of the engine. (The power crank and the displacer crank are, it should be mentioned, set at right angles to one another.) During the second half of the power stroke the displacer is moved downwards, causing some of the air to pass round it into contact with the cold plate D. It immediately contracts, and reduces the pressure on the power piston by the time that the piston has finished its stroke. When the power piston has reached the middle of its downward stroke, the displacer is at its lowest position, but is halfway up again when the power piston is quite down. The air is once again displaced downwards, and the cycle begins anew. The motive power is, therefore, provided by the alternate heating and cooling of the same air.

**Construction.** -- The barrel and supports were made out of a single piece of thin brass tubing, 2-7/16 inch internal diameter and 5-5/8 inch long. The heating end was filed up true, the other cut and filed to the shape indicated in Fig. 98 by dotted lines. The

marking out was accomplished with the help of a strip of paper exactly as wide as the length of the tube, and as long as the tube's circumference. This strip had a line ruled parallel to one of its longer edges, and 2-1/2 inches from it, and was then folded twice, parallel to a shorter edge. A design like the

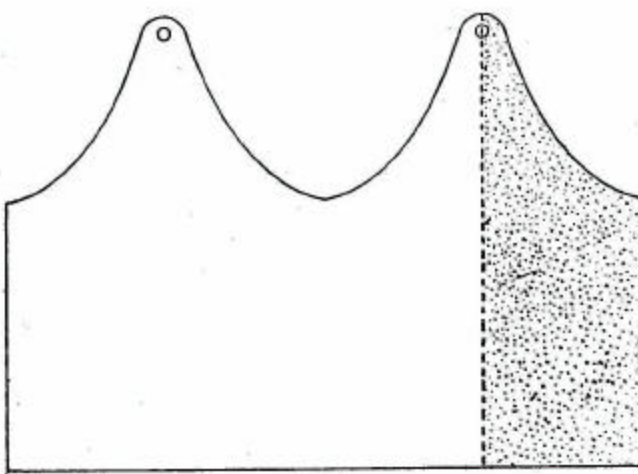

FIG. 98-

shaded part of Fig. 98 was drawn on an end fold, and all the four folds cut through along this line with a pair of scissors. When opened out, the paper appeared as in Fig. 98.

We now -- to pass into the present tense -- wrap this pattern round the tube and scratch along its

edges. The metal is removed from the two hollows by cutting out roughly with a hack saw and finishing up to the lines with a file.

The next things to take in hand are the displacer rod D and the guide tube in which it works. These must make so good a fit that when slightly lubricated they shall prevent the passage of air between them and yet set up very little friction. If you cannot find a piece of steel rod and brass tubing which fit close enough naturally, the only alternative is to rub down a rod, slightly too big to start with, until it will just move freely in the tube. This is a somewhat tedious business, but emery cloth will do it. The rod should be 3-3/8 inches, the tube 2-1/8 inches, long. I used rod 3/16 inch in diameter; but a smaller rod would do equally well.

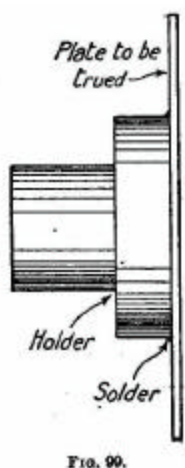

FIG. 99.

The two plates, A and B, are next prepared by filing or turning down thin brass[1] discs to a tight fit. (Note.-- For turning down, the disc should be soldered centrally to a piece of accurately square

[Footnote 1: Thin iron plate has the disadvantage of soon corroding.]

brass rod, which can be gripped in a chuck. I used a specially-made holder like that shown in Fig. 99 for this purpose.)

When a good fit has been obtained, solder the two discs together so that they coincide exactly, and bore a central hole to fit the guide tube tightly. Before separating the plates make matching marks, so that the same parts may lie in the same direction when they are put in position. This will ensure the guide tube being parallel to the barrel.

The power cylinder is a piece of brass tubing 2 inches long and of 7/8-inch internal diameter. The piston is of 7/8-inch tubing, fitting the cylinder easily, and thick enough to allow a shallow packing recess to be turned in the outside. Brass washers turned or filed to size form the ends of cylinder and piston. The connecting rod CR2 is a piece of strip brass, 3-3/16 inches long, between centres of holes. This had better be cut off a bit long in the first instance, and be fitted to the little stirrup which attaches its lower end to the piston. The drilling of the crank pinhole should be deferred till the cylinder and crank are in position.

**Putting in the Water-chamber Discs.** -- Clean the inside of the barrel thoroughly with sandpaper;



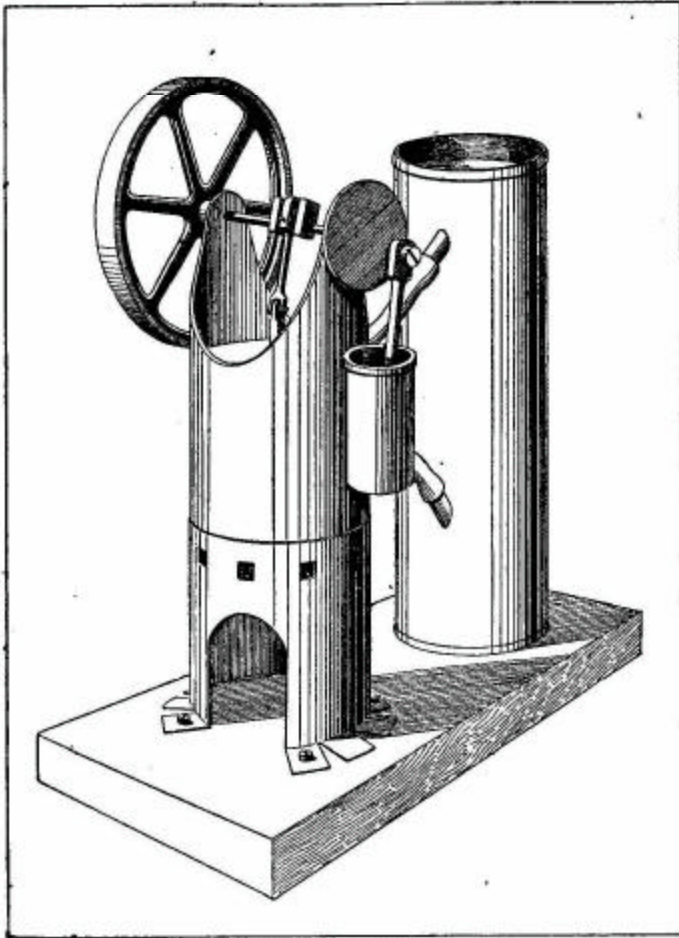

FIG. 100.—Exterior view of hot-air engine.

FIG. 100. -- Exterior view of hot air engine.

also discs A and B round the edges and the central holes. Disc A is forced in from the crank end a little further down than it is to be finally, and then driven up from below until at all points its lower side is exactly three inches from the bottom edge of the barrel. Disc B is then forced up 1-1/2 inches from the bottom end. The guide tube - which should have been cleaned -- having been driven into place, solder is run all round the joints. If the barrel is heated over a spirit lamp, this operation is performed very quickly. ("Tinol" soldering paste is recommended.) Before soldering in B, drill a small hole in the barrel between A and B to allow the air to escape.

**Attaching the Cylinder.** -- Scratch a bold line through the centre of one of the crank holes to the bottom of the barrel, to act as guide. Drill a 5/32-inch hole in the barrel on this line just below plate B, and a similar hole in the bottom of the cylinder. (The cylinder end should be put in position temporarily while this is done to prevent distortion.) Flatten down the cylinder slightly on the line of the hole, so that it may lie snugly against the barrel, and clean the outside of the barrel. Lay the cylinder against the barrel with the holes opposite one another, and push a short piece of wood through to exclude solder from the holes and keep the holes in line.

Half a dozen turns of fine wire strained tightly round cylinder and barrel will hold the cylinder in place while soldering is done with a bit or lamp. The end of the cylinder should then be made fast.

**The Displacer.** -- This is a circular block of wood -- well dried before turning --  $5/8$  inch thick and  $3/32$  inch less in diameter than the inside of the barrel. The rod hole in it should be bored as truly central as possible. A hole is drilled edgeways through the block and through the rod to take a pin to hold the two together. To prevent it splitting with the heat, make a couple of grooves in the sides to accommodate a few turns of fine copper wire, the twisted ends of which should be beaten down flush with the outside of the block. The bottom of the block is protected by a disc of asbestos card held up to the wood by a disc of tin nailed on.

**The Crank Shaft and Crank.** -- The central crank of the crank shaft -- that for the displacer -- has a "throw" of  $1/4$  inch, as the full travel of the displacer is  $1/2$  inch. If the bending of a rod to the proper shape is beyond the reader's capacity, he may build up a crank in the manner shown in Fig. 101. Holes for the shaft are bored near the tops of the supports, and the shaft is put in place. After this has been

done, smoke the shaft in a candle flame and solder two small bits of tubing, or bored pieces of brass, to the outside of the supports to increase the length of the bearing. The power-crank boss is a 1-1/2-inch brass disc. This crank has a "throw" of 1/2 inch.

**Connecting Rods.** -- Put a piece of card 1/16 inch thick in the bottom of the cylinder and push the piston home. Turn the power crank down and

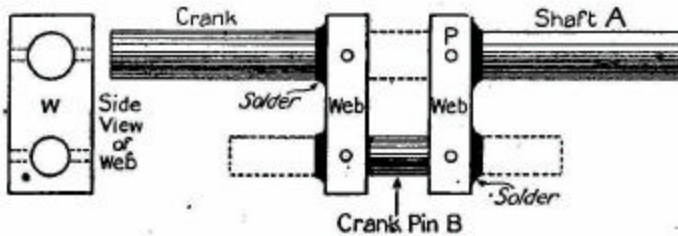

FIG. 101.—Details of built-up crank.

mark off the centre of the hole for the crank pin in the connecting rod CR2. Solder a piece of strip brass on each side of the rod at this point; measure again, and drill.

The top of the displacer rod D is now filed flat on two sides and drilled. Slip a ring 1/16 inch thick over the rod and push the rod upwards through the guide tube till the displacer can go no farther. Turn the displacer crank up and measure from the centre of the hole in the rod to the centre of the crank.

The top of the connecting rod should be filed to fit the under side of the crank, against which it should be held by a little horseshoe-shaped strap pinned on. (Fig. 102). (Be sure to remove the ring after it has served its purpose.)

**The Water Circulation.** -- The water chamber is connected by two rubber tubes with an external tank. In Fig. 97 the cooling water tank is shown, for illustrative purposes, on the fly-wheel side of the engine, but can be placed more conveniently behind the engine, as it were. Two short nozzles, E1 and E2, of 1/4-inch tube are soldered into the water chamber near the top and bottom for the rubber pipes to be slipped over, and two more on the water tank. For the tank one may select a discarded 1 lb. carbide tin. Cut off the top and solder on a ring of brass wire; make all the joints water-tight with solder, and give the tin a couple of coatings of paint inside and outside.

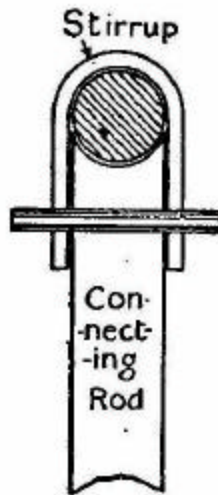

FIG. 102.

FIG. 102.

**Closing the Hot-air Chamber.** -- When all the parts except the lamp chamber have been prepared, assemble them to make sure that everything is in order. The lower end of the hot-air chamber has then to be made air-tight. Soldering is obviously useless here, as the heat of the lamp would soon cause the solder to run, and it is impossible to make a brazed joint without unsoldering the joints in the upper parts of the engine. I was a bit puzzled over the problem, and solved it by means of the lower part of an old tooth-powder box stamped out of a single piece of tin. This made a tight fit on the outside of the barrel, and as it was nearly an inch deep, I expected that if it were driven home on the barrel and soldered to it the joint would be too near the water chamber to be affected by the lamp. This has proved to be the case, even when the water is nearly at boiling point. If a very close-fitting box is not procurable, the space between box and barrel must be filled in with a strip of tin cut off to the correct length.

**The Lamp Chamber.** -- Cut out a strip of tin 4 inches wide and 1 inch longer than the circumference of the lower end of the hot-air chamber. Scratch a line  $\frac{1}{2}$  inch from one of the sides, a line  $\frac{3}{4}$  inch from the other, and a line  $\frac{1}{2}$  inch from each of the ends.

A lamp hole is cut in the centre, and ventilation holes 1 inch apart, as shown in Fig. 103. If the

latter holes are made square or triangular (base uppermost), and the metal is cut with a cold chisel so as to leave the side nearest the edge unsevered, the parts may be turned up to form supports for the barrel.

The slit lower side of the plate is splayed out into a series of "feet," by three or more of which, the chamber is secured to the base. Bend the plate

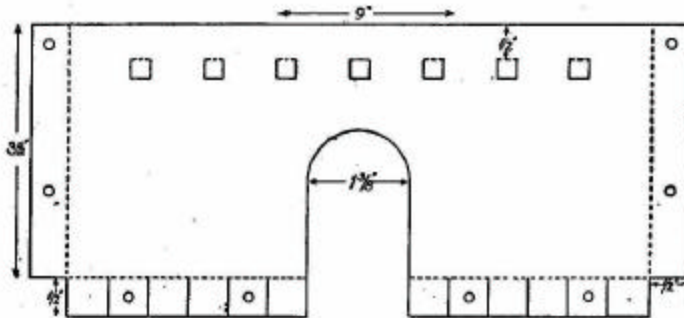

FIG. 103.—Plate for lamp chamber cut out ready for bending.

FIG. 103. -- Plate for lamp chamber cut out ready for bending.

round the barrel and put the two screws and bolts which hold the ends in place, and tighten them until the barrel is gripped firmly. Screw the engine to its base, fit on the rubber water connections, and fasten down the tank by a screw through the centre of the bottom. The screw should pass through a brass washer, between which and the tank should be interposed a rubber washer to make a water-tight joint.

**The Lamp.** -- The lamp shown in Fig. 104 was made out of a truncated brass elbow, a piece of 5/16-inch brass tube, and a round tin box holding about 1/3- pint of methylated spirit. A tap interposed between the reservoir and burner assists regulation of the flame, and prevents leakage when the lamp is not in use.

**Running the Engine.** -- The power and displacer cranks must be set exactly at right angles to one another, and the first be secured by soldering or

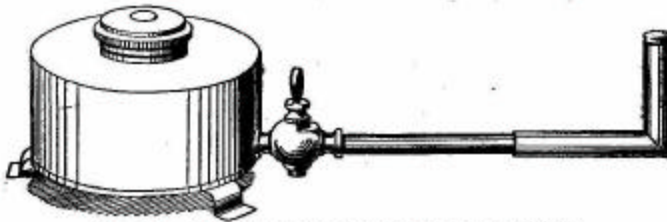

FIG. 104.—Spirit lamp for hot-air engine, with regulating tap.

FIG. 104.-Spirit lamp for hot-air engine, with regulating tap.

otherwise to the crank shaft. The fly wheel will revolve in that direction in which the displacer crank is 90 degrees ahead of the other.

The packing of the piston should be sufficiently tight to prevent leakage of air, but not to cause undue friction. When the packing has settled into place, an occasional drop of oil in the cylinder and guide tube will assist to make the piston and slide air-tight.



The engine begins to work a quarter of a minute or so after the lamp is lit, and increases its speed up to a certain point, say 300 revolutions per minute. When the water becomes very hot it may be changed. The power might be applied, through demultiplying gear, to a small pump drawing water from the bottom of the tank and forcing it through the water chamber and a bent-over stand pipe into the tank again. This will help to keep the water cool, and will add to the interest of the exhibit by showing "work being done."

**XXI.**  
**A WATER MOTOR.**

FIG. 105 is a perspective view of a simple water motor which costs little to make, and can be constructed by anybody able to use carpenter's tools and a soldering iron. It will serve to drive a very small dynamo, or do other work for which power on a small scale is required. A water supply giving a pressure of 40 lbs. upwards per square inch must be available.

We begin operations by fashioning the case, which consists of three main parts, the centre and two sides, held together by brass screws. For the centre, select a piece of oak 1 inch thick. Mark off a square, 7 inches on the side; find the centre of this, and describe a circle 5 inches in diameter. A bulge is given to the circle towards one corner of the square, at which the waste-pipe will be situated.

Cut out along the line with a keyhole saw. Then saw out the square of wood. A 5/8-inch hole is now

bored edgeways through the wood into the "bulge" for the escape, and in what will be the top edge is drilled a 1/4-inch hole to allow air to enter.

Cut out the sides, and screw them on to the centre at the four corners, taking care that the grain runs the same way in all three pieces, so that they may

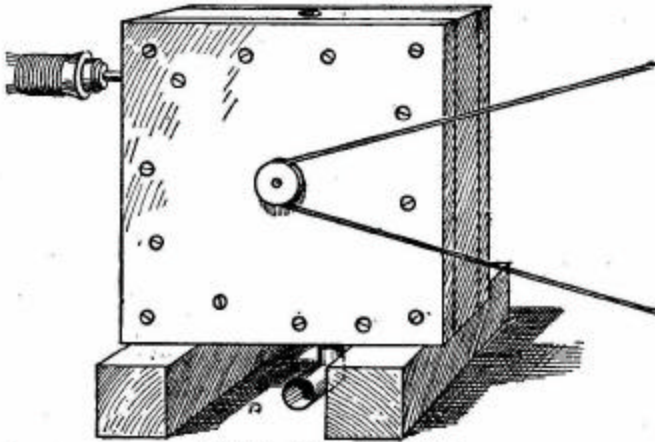

FIG. 105.—Simple water turbine.

FIG. 105. - Simple water turbine.

all expand or contract in the same direction. Plane off the edges of the sides flush with the centre.

The parts should now be separated, after being marked so that they can be reassembled correctly, and laid for a quarter of an hour in a pan of melted paraffin wax, or, failing this, of vaseline, until the wood is thoroughly impregnated. Reassemble the

parts, and put in the rest of the holding screws, which should have their heads countersunk flush with the wood.

For the shaft select a piece of steel rod  $\frac{5}{32}$  inch in

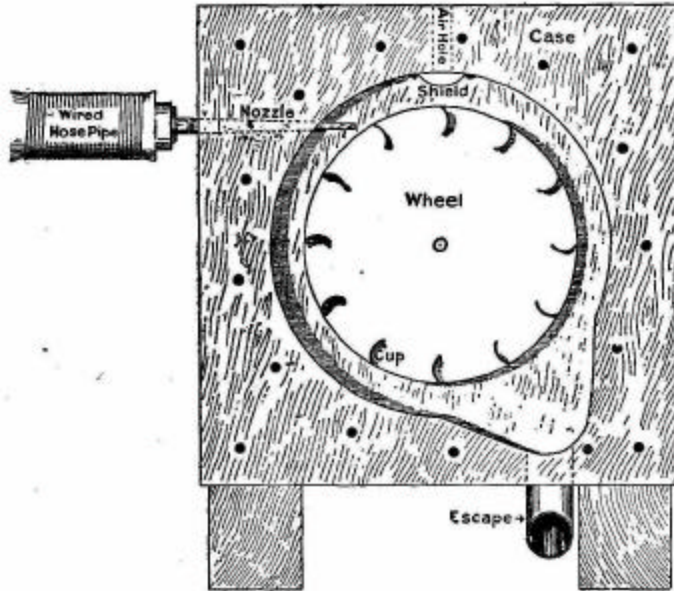

FIG. 106.—Water turbine, with pulley side of casing removed.

FIG. 106.- Water turbine, with pulley side of casing removed.

diameter, and 3 or 4 inches long; for the bearings use two pieces,  $\frac{3}{4}$  inch long each, of close-fitting brass tube. Now take a drill, very slightly smaller in diameter than the bearings, and run holes right through the centres of, and square to, the sides. Both

holes should be drilled at one operation, so that they may be in line.

With a wooden mallet drive the bearings, which should be tapered slightly at the entering end, through the sides. Push the shaft through them. If it refuses to pass, or, if passed, turns very unwillingly, the bearings must be out of line; in which case the following operation will put things right. Remove the bearing on the pulley side, and enlarge the hole slightly. Then bore a hole in the centre of a metal disc, 1 inch in diameter, to fit the bearing; and drill three holes for screws to hold the disc against the case. Rub disc and bearing bright all over.

Replace the bearing in its hole, slip the disc over it, and push the shaft through both bearings. Move the disc about until the shaft turns easily, mark the screw holes, and insert the screws. Finally, solder the bearing to the disc while the shaft is still in place.

The wheel is a flat brass disc 4 inches in diameter. Polish this, and scratch on one side twelve equally spaced radii. At the end of each radius a small cup, made by bending a piece of strip brass 1/4 inch wide and 1/2 inch long into an arc of a circle, is soldered with its extremities on the scratch. A little "Tinol"

soldering lamp (price 1s. 6d.) comes in very handy here.

To fix the wheel of the shaft requires the use of a third small piece of tubing, which should be turned off quite square at both ends. Slip this and the wheel on the shaft, and make a good, firm, soldered joint. *Note.* -- Consult Fig. 107 for a general

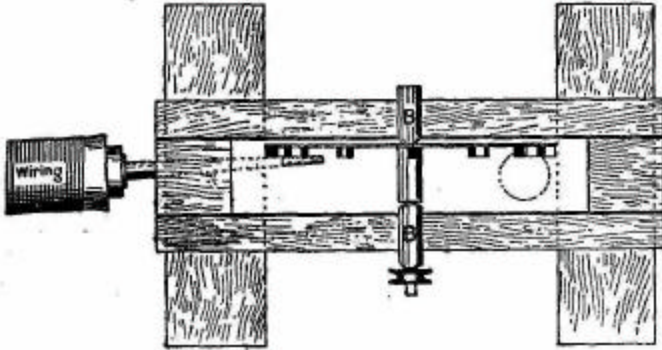

FIG. 107.—Plan of water turbine, showing arrangement of nozzle.

FIG. 107. -- Plan of water turbine, showing arrangement of nozzle.

idea of the position of the wheel, which must be kept just clear of the case by the rear bearing.

The nozzle should be a straight, tapered tube of some kind -- the nose of a large oil can will serve the purpose. The exit must be small enough to allow the water to leave it at high velocity; if too large, the efficiency of the wheel will be diminished. To the rear end of the nozzle should be soldered a piece

of brass tubing, which will make a tight fit with the hose pipe leading from the water supply. A few small brass rings soldered round this piece will prevent the hose blowing off if well wired on the outside.

Now comes the boring of the hole for the nozzle. Fig. 106 shows the line it should take horizontally, so that the water shall strike the uppermost bucket just below the centre; while Fig. 107 indicates the obliquity needed to make the stream miss the intervening bucket. A tapered broach should be used to enlarge the hole gradually till the nozzle projects sufficiently. If the line is not quite correct, the tip should be bent carefully in the direction required. One must avoid distorting the orifice, which should be perfectly circular; clean it out with a small twist drill of the proper size.

A brass elbow, which may be purchased for a few pence, should be driven into the waste hole, and a small shield be nailed under the air hole. A couple of screwed-on cross pieces are required to steady the motor sideways and raise the elbow clear of the ground.

The motor may be geared direct to a very small dynamo, if the latter is designed to run at high

speeds. If a geared-down drive is needed, a small pulley--such as is used for blinds, and may be bought for a penny -- should be attached to the shaft, and a bootlace be employed as belt. Avoid overloading the wheel, for if it is unable to run at a high speed it will prove inefficient.

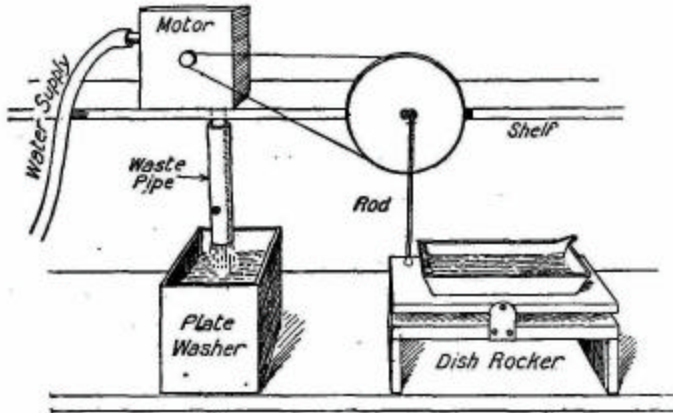

FIG. 108.—Water motor working a photographic dish-rocker.

FIG. 108.—Water motor working a photographic dish-rocker.

**Lubrication.** -- The water will keep the bearings cool, but the bearings should be well lubricated. The most convenient method of effecting this is to bore holes in the bearings, and from them run small pipes to an oil reservoir on the top of the case (as in Fig. 70), where they are fed on the siphon principle through strands of worsted.

**Alternative Construction.** -- If an all-metal case is



preferred, the reader might utilize the description given of a steam turbine on pp. 170-178. The details there given will apply to water as well as steam, the one exception being that a nozzle of the kind described above must be substituted for the steam pipe and small ports.

## XXII. MODEL PUMPS.

Every steam boiler which has to run for long periods and evaporate considerable quantities of water should be in connection with a pump capable of forcing water in against the highest pressure used. On a previous page (p. 158) we have described a force pump driven directly off the crank shaft of an engine. As the action of this is dependent on the running of the engine, it is advisable, in cases where the boiler may have to work an engine not provided with a pump of its own, to install an independent auxiliary pump operated by hand or by steam, and of considerable capacity, so that in an emergency water may be supplied quickly.

**Making a Hand pump.** -- Fig. 109 shows the details of a hand pump which is easy to make. The barrel is a length of brass tubing; the plunger a piece of brass or preferably gun-metal rod, which fits the tube closely, but works easily in it. The gland at the top of the barrel, E, is composed of a piece, D, of

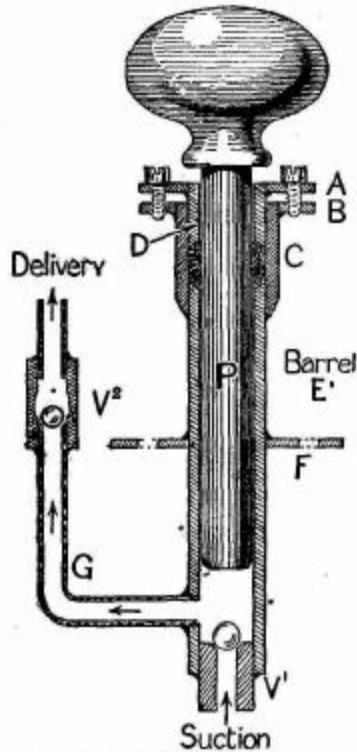

FIG. 109.—Vertical section of force pump.

FIG. 109.—Vertical section of force pump.

the same tubing as the barrel, sliding in a collar, C, soldered to E. The bottom of D and top of E are bevelled to force the packing against the plunger. The plates A and B, soldered to D and C respectively, are drawn together by three or more screws. A brass door-knob makes a convenient top for the plunger. When the knob touches A, the bottom of the plunger must not come lower than the top of the delivery pipe, lest the water flow should be impeded and the valve, V, injured. Round off the end of the plunger, so that it

may be replaced easily and without disarranging the packing if pulled out of the pump.

The valves are gun-metal balls, for which seats have been prepared by hammering in steel cycle balls of the same size. Be careful to select balls considerably larger than the bore of the pipes on which they rest, to avoid all possibility of jamming. An eighth of an inch or so above the ball, cross wires should be

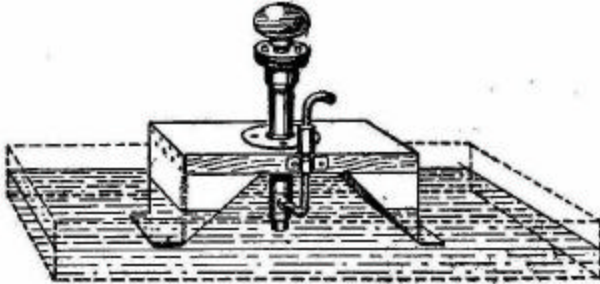

FIG. 110.

FIG. 110.

soldered in to prevent the ball rising too far from its seat.

A convenient mounting for a hand pump is shown in Fig. 110. The plate, F, of the pump is screwed to a wooden base resting on a framework of bent sheet zinc, which is attached to the bottom of a zinc water tray. The delivery pipe, G, will be protected against undue strains if secured by a strap to the side of the wooden base.

The same pump is easily adapted to be worked by

a lever, which makes the work of pumping easier. Fig. 111 gives details of the top of the plunger and the links, B. A slot must be cut in the plunger for the lever, A, to pass through, and the sides bored for a pivot pin. The links are straddled (see sketch of end view) to prevent the back end of the lever wobbling from side to side.

**A Steam Pump.** -- The pump illustrated in Fig. 112

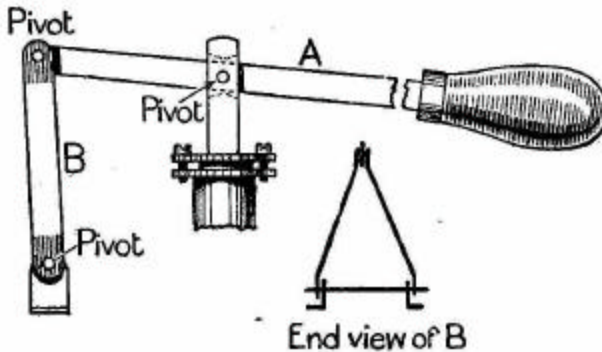

FIG. 111.—Details of lever for force pump.

FIG. 111. -- Details of lever for force pump.

belongs to what is probably the simplest self-contained type, as no fly wheel, crank, or eccentric is needed for operating the valve.

The steam cylinder and the pump are set in line with one another (in the case shown, horizontally), and half as far apart again as the stroke of the cylinder. The plunger is either a continuation of the piston rod, or attached to it.

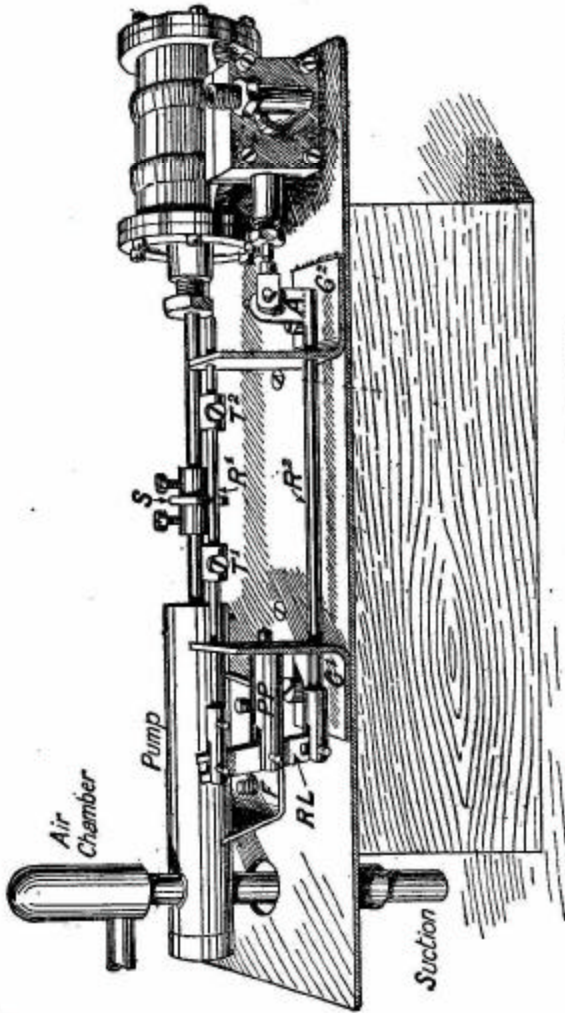

FIG. 112.—View of steam pump, showing details.

FIG. 112 -- View of steam pump, showing details.

An arm, S, fixed at right angles to the piston rod, has a forked end which moves along the rod. This rod is connected with the slide valve through the rocking arm, R1 and the rod, R2. On it are two adjustable stops, T1 T2, which S strikes alternately towards the end of a stroke, causing the valve to shift over and expose the other side of the piston to steam pressure. The absence of the momentum of a fly wheel makes it necessary for the thrust exerted by the piston to be considerably greater than the back pressure of the water, so that the moving parts may work with a velocity sufficient to open the valve. If the speed falls below a certain limit, the valve opens only part way, the speed falls, and at the end of the next stroke the valve is not shifted at all.

The diameter of the plunger must be decided by the pressure against which it will have to work. For boiler feeding it should not exceed one-third that of the piston; and in such case the piston rod and plunger may well be one.

A piston valve, being moved more easily than a box valve, is better suited for a pump of this kind, as friction should be reduced as much as possible.

**CONSTRUCTION.**

The cylinder will not be described in detail, as hints on making a slide-valve cylinder have been given on earlier pages. The piston rod should be three times as long as the stroke of the cylinder, if it is to serve as pump plunger; and near the pump end an annular groove must be sunk to take a packing.

The pump, if designed to work horizontally, will have the valves arranged like the pump illustrated in Fig. 65; if vertically, like the pump shown in Fig. 109. Both suction and delivery pipes should be of ample size, as the pump works very fast. The pump is mounted on a foot, F, made by turning up the ends of a piece of brass strip, and filing them to fit the barrel.

The bed can be fashioned out of stout sheet brass or zinc. Let it be of ample size to start with, and do not cut it down until the pump is complete. Rule a centre line for cylinder and pump, and mount the cylinder. Pull out the piston rod plunger as far as it will go, and slip the pump barrel on it. The foot of the pump must then be brought to the correct height by filing and spreading the ends until the



plunger works quite easily in the pump, when this is pressed down firmly against the bed. When adjustment is satisfactory, mark the position of the foot on the bed, solder foot to barrel, and drill and tap the foot for the holding-down screws. Don't forget that the distance between pump and cylinder gland must be at least 1-1/3 times the stroke.

The valve motion can then be taken in hand. Cut off for the guides, G1 G2, two pieces of stout brass strip, 2-1/2 inches long and 3/4 inch wide. Lay them together in a vice, and bore the holes (Fig. 113) 1-1/4 inches apart, centre to centre, for the 1/8-inch rods, R1 R2. The feet are then turned over and a third hole bored in G1, midway between those previously made, to take the end of the support, PP, of the rocking lever.

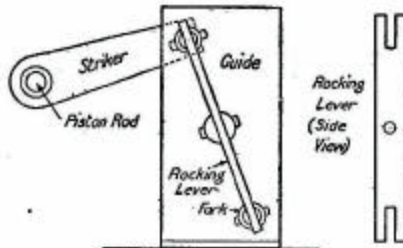

FIG. 113.—End view of striking mechanism of steam pump.

FIG. 113. -- End view of striking mechanism of steam pump.

Screw G1 G2 down to the bedplate, 3/4 inch away from the cylinder centre line. G1 is abreast of the mouth of the pump, G2 about half an inch forward of the end of the cylinder.

**The striker, S**, is a piece of brass strip soldered to 1/2 inch of tubing fitting the piston rod. (See Fig. 113.) Its length is decided by running a rod through the upper holes in G1 G2, allowance being made for the notch in the end. The collar is tapped for two screws, which prevent S slipping on the piston rod. The rods for R1 R2 are now provided with forks, made by cutting and filing notches in bits of brass tubing. The notches should be half as deep again as the rocking lever is wide, to give plenty of room for movement. Solder the forks to the rods, and put the rods in place in the guides, with the forks as far away from G1 as the travel of the slide valve. Then measure to get the length of the rocking lever support. One end of this should be filed or turned down to fit the hole drilled for it; the other should be slotted to fit the lever accurately.

The rocking lever, RL, which should be of steel, is slotted at each end to slide on the pins in the forks, and bored for the pivot pin, which, like those in the forks, should be of hardened steel wire. Assemble the rocking lever in its support and the rod forks, and solder on the support.

To the back end of R2 solder a steel plate, A, which must be bored for the pin in the valve fork,

after the correct position has been ascertained by careful measurement.

The stops, T1 T2, are small, adjustable collars, kept tightly in place on R1 by screws.

**Setting the Striker.** -- Assemble all the parts. Pull out the piston rod as far as it will go, and push the slide valve right back. Loosen the striker and the forward stop, and slide them along in contact until the striker is close to the pump. Tighten up their screws. Then push the piston rod fully in, draw the valve rod fully out, and bring the rear stop up against the striker, and make it fast. Each stop may now be moved 1/16 inch nearer to a point halfway between them to cause "cushioning" of the piston, by admitting steam before the stroke is quite finished.

A pump made by the author on this principle, having a 1-1/4 inch stroke and a 1/2-inch bore, will deliver water at the rate of half a gallon per minute against a head of a few feet.

*Note.* -- To steady the flow and prevent "water hammer," a small air-chamber should be attached to the delivery pipe.

**An Alternative Arrangement.** -- If the reader prefers a steam pump which will work at slow speeds, and be available, when not pumping, for driving purposes,

the design may be modified as shown diagrammatically in Fig. 114. The striker becomes a cross head, and is connected by a forked rod passing on each side of the pump with the crank of a fly wheel overhanging the base. The valve is operated in the ordinary manner by an eccentric on the crankshaft. The steadying effect of the fly wheel and the positive action of the valve make it possible to use a larger pump plunger than is advisable with the striking gear. With a pump piston of considerably greater diameter than the piston rod, the pump may be made

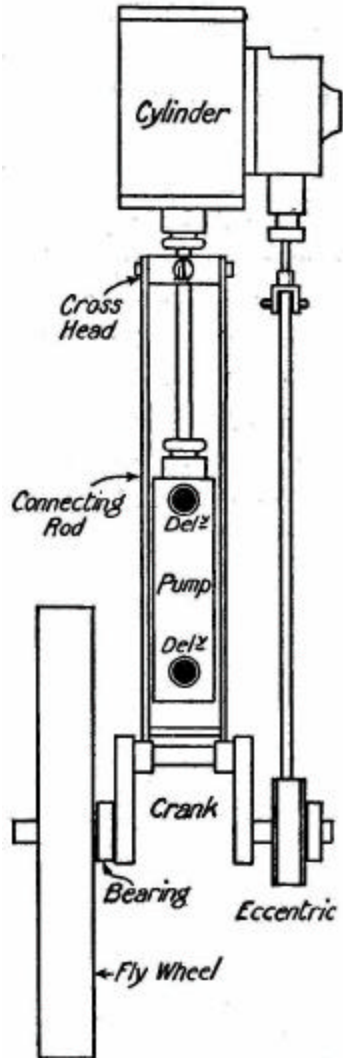

FIG. 114.—Plan of steam pump with fly wheel.

Fig. 114. -- Plan of steam pump with fly wheel.

double-acting, a gland being fitted at the front end for the piston rod to work through, and, of course, a second set of valves added.

#### **A SUGGESTION.**

For exhibition purposes a small, easily running, double-action pump might be worked by the spindle of a gramophone. A crank of the proper throw and a connecting rod must be provided. Both delivery pipes feed, through an air-chamber, a fountain in the centre of a bowl, the water returning through an overflow to the source of supply, so that the same water may be used over and over again.

**XXIII.  
KITES.**

**Plain Rectangular Box Kites.** -- The plain box kite is easy to make and a good flier. Readers should try their hands on it before attempting more complicated models.

Lifting pressure is exerted only on the sides facing the wind, but the other sides have their use in steadying the kite laterally, and in holding in the wind, so that they justify their weight.

**Proportions of Box.** -- Each box has wind faces one and a third times as long as the sides, and the vertical depth of the box is about the same as its fore and aft dimensions. That is, the ends of the boxes are square, and the wind faces oblong, with one-third as much area again as the ends. Little advantage is to be gained from making the boxes proportionately deeper than this.

The distance between the boxes should be about equal to the depth of each box.

### CONSTRUCTION.

After these general remarks, we may proceed to a practical description of manufacture, which will apply to kites of all dimensions. It will be prudent to begin on small models, as requiring small outlay.

Having decided on the size of your kite, cut out two pieces of material as wide as a box is to be deep, and as long as the circumference of the box *plus* an inch and a half to spare. Machine stitch  $\frac{5}{8}$  inch tapes along each edge, using two rows of stitching about  $\frac{1}{8}$  inch from the edges of the tape. Then double the piece over, tapes inside, and machine stitch the ends together, three quarters of an inch from the edge. *Note.* -- All thread ends should be tied together to prevent unravelling, and ends of stitching should be hand-sewn through the tape, as the greatest strain falls on these points.

The most convenient shape for the rods is square, as fitting the corners and taking tacks most easily. The sectional size of the rods is governed by the dimensions of the kite, and to a certain extent by the number of stretchers used. If four stretchers are

employed in each box, two near the top and two near the bottom, the rods need not be so stout as in a case where only a single pair of central stretchers is preferred.

Lay the two boxes flat on the floor, in line with one another, and the joints at the same end. Pass two rods through, and arrange the boxes so that the outer edges are 1/2 inch from the ends of the rods. (These projections protect the fabric when the kite strikes the ground).

Lay the rods on one corner, so that the sides make an angle of 45 degrees with the floor, pull the boxes taut -- be careful that they are square to the rods -- and drive three or four tacks through each end of the box into the rods. Then turn them over and tack the other sides similarly. Repeat the process with the other rods after measuring to get the distances correct.

The length of the stretchers is found approximately by a simple arithmetical sum, being the square root of the sum of the squares of the lengths of two adjacent sides of the box. For example, if each box is 20 by 15 inches, the diagonal is the square root of (20 squared plus 15 squared) = square root of 625 = 25 inches. The space occupied by the vertical rods will about offset the stretch of the material, but to be on



the safe side and to allow for the notches, add another half-inch for small kites and more proportionately for large ones. It is advisable to test one pair of stretchers before cutting another, to reduce the effect of miscalculations.

The stretcher notches should be deep enough to grip the rods well and prevent them twisting, and one must take care to have those on the same stretcher exactly in line, otherwise one or other cannot possibly "bed" properly. A square file is useful for shaping the notches.

Ordinarily stretchers do not tend to fall out, as the wind pressure puts extra strain on them and keeps them up tight. But to prevent definitely any movement one may insert screw eyes into the rods near the points at which the stretchers press on them, and other eyes near the ends of the stretchers to take string fastenings. These attachments will be found useful for getting the first pair of stretchers into position, and for preventing the stretchers getting lost when the kite is rolled up.

The bridle is attached to four eyes screwed into the rods near the tops of the boxes. (See Fig. 118.) The top and bottom elements of the bridle must be paired off to the correct length; the top being

considerably shorter than the bottom. All four parts may be attached to a brass ring, and all should be taut when the ring is pulled on. The exact adjustment must be found by experiment. In a very high wind it is advisable to shorten the top of the bridle if you have any doubt as to the strength of your string, to flatten the angle made by the kite with the wind.

**Diamond Box Kites.** -- In another type of box kite

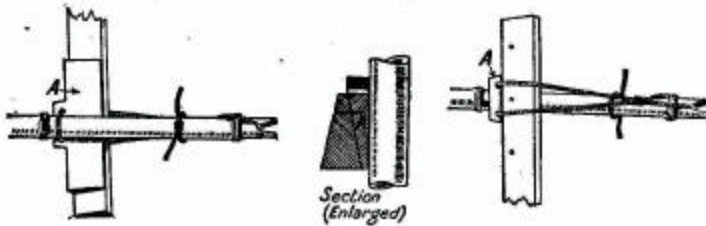

FIG. 115.—Details of stretcher attachment for diamond-shaped box kites.

FIG. 115. -- Details of stretcher attachment for diamond-shaped box kites.

the boxes have four equal sides, but the boxes are rhombus-shaped, as in Fig. 116, the long diagonal being square to the wind, and the bridle attached at the front corner.

For particulars of design and construction I am much indebted to Mr. W. H. Dines, F.R.S., who has used the diamond box kite for his meteorological experiments to carry registering meteorographs several thousands of feet into the air.

The longitudinal sticks used at the corners have the section shown in Fig. 115. They are about four times as wide at the front edge, which presses against the fabric, as at the back, and their depth is about twice the greater width. This shape makes it easy to attach the shorter stretchers, which have their ends notched and bound to prevent splitting.

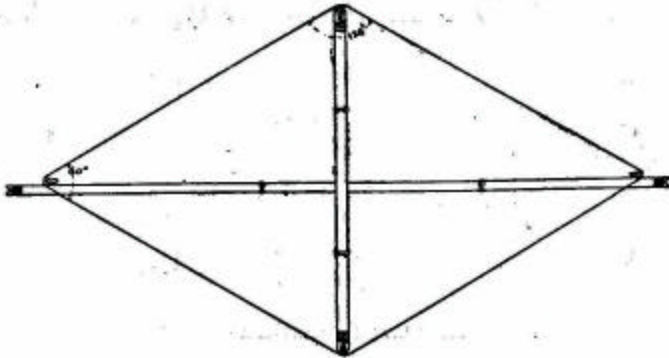

FIG. 116.—Plan of diamond box kite, showing arrangement of stretchers.

FIG. 116. -- Plan of diamond box kite, showing arrangement of stretchers.

Fig. 117 is a perspective diagram of a kite. The sail of each box measures from top to bottom one-sixth the total circumference of the box, or, to express the matter differently, each face of the box is half as long again as its depth. The distance separating the boxes is equal to the depth of a box.

The sides of a box make angles of 60 degrees and 120 degrees with one another, the depth of the space enclosed from front to back being the same as the length of a side. With these angles the *effective* area of the sails is about six-sevenths of the total area. Therefore a kite of the dimensions given in Fig. 117 will have an effective area of some thirty square feet.

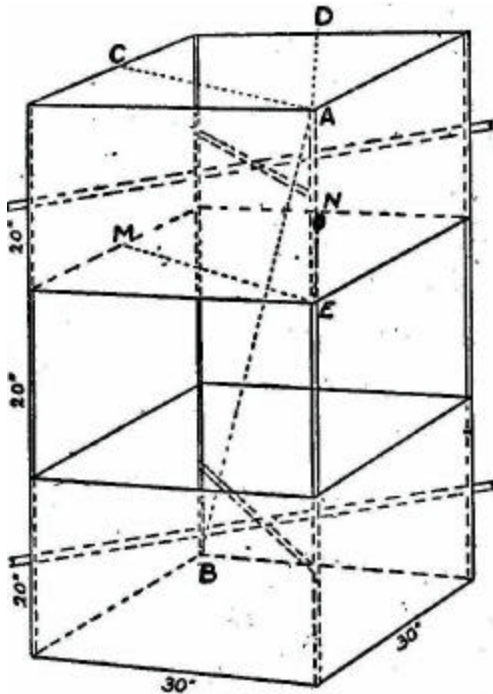

FIG. 117.—Diamond box kite in perspective. Ties are indicated by fine dotted lines.

FIG. 117. -- Diamond box kite in perspective. Ties are indicated by fine dotted lines.

The long stretchers pass through holes in the fabric close to the sticks, and are connected with the sticks by stout twine. Between stretcher and stick is interposed a wedge-shaped piece of wood (A in Fig. 115), which prevents the stick being drawn out of line. This method of attachment enables the boxes to be kept tight should the fabric stretch at all--as generally happens after some use; also it does away

with the necessity for calculating the length of the stretchers exactly.

The stretchers are tied together at the crossing points to give support to the longer of the pair.

The dotted lines AB, AC, AD, EM, and EN in Fig. 117 indicate ties made with wire or doubled and hemmed strips of the fabric used for the wings. AB, running from the top of the front stick to the bottom of the back stick, should be of such a length that, when the kite is stood on a level surface, the front and back sticks make right angles with that surface, being two sides of a rectangle whereof the other two sides are imaginary lines joining the tops and bottoms of the sticks. This tie prevents the back of the kite drooping under pressure of the wind, and increases the angle of flight. The other four ties prevent the back sails turning over at the edges and spilling the wind, and also keep them flatter. This method of support should be applied to the type of kite described in the first section of this chapter.

**String Attachment.** -- A box kite will fly very well if the string is attached to the top box only. The tail box is then free to tilt up and trim the kite to varying pressures independently of the ascent of the kite as a whole. When the bottom box also is

connected to the string it is a somewhat risky business sending a kite up in a high wind, as in the earlier part of the ascent the kite is held by the double

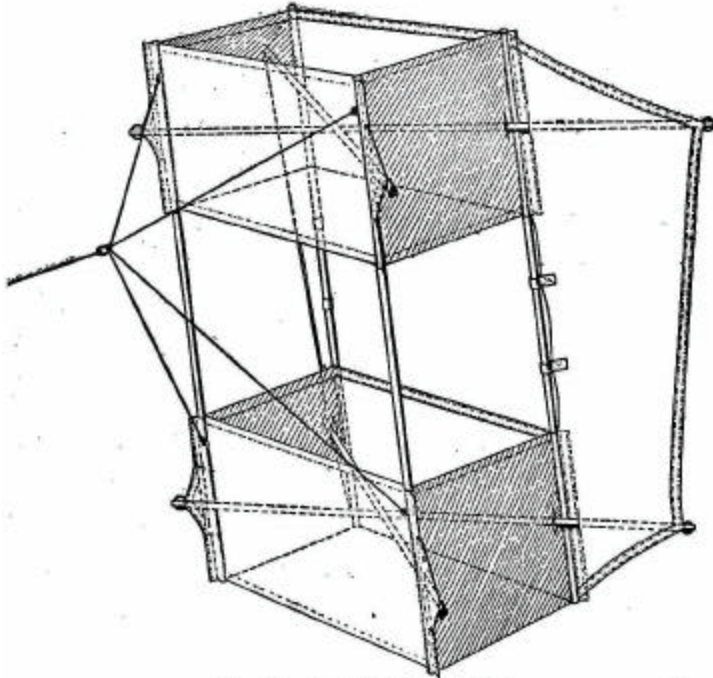

FIG. 118.—Box kite with rear wings.

FIG. 118. -- Box kite with rear wings.

bridle fairly square to the wind. If any doubt is entertained as to the ability of the string to stand the pressure, the one-box attachment is preferable, though possibly it does not send the kite to as great a height

as might be attained under similar conditions by the two-box bridle.

When one has to attach a string or wire to a large kite at a single point, the ordinary method of using an eye screwed into the front stick is attended by obvious risks. Mr. Dines employs for his kites (which measure up to nine feet in height) an attachment which is independent of the front stick. Two sticks, equal in length to the width of the sail, are tacked on to the inner side of the sail close to the front stick. Rings are secured to the middle of the sticks and connected by a loop of cord, to which the wire (in this case) used for flying the kite is made fast.

**A Box Kite with Wings.** -- The type of kite shown in Fig. 118 is an excellent flyer, very easy, to make and very portable. The two boxes give good longitudinal stability, the sides of the boxes prevent quick lateral movements, and the two wings projecting backwards from the rear corners afford the "dihedral angle" effect which tends to keep the kite steadily facing the wind. The "lift," or vertical upward pull, obtained with the type is high, and this, combined with its steadiness, makes the kite useful for aerial photography, and, on a much larger scale, for man-lifting.

The materials required for the comparatively small example with which the reader may content himself in the first instance are:-

8 wooden rods or bamboos, 4 feet long and 1/2 inch in diameter.

4 yards of lawn or other light, strong material, 30 inches wide.

12 yards of unbleached tape, 5/8 inch wide.

8 brass rings, 1 inch diameter.

**The Boxes.** -- Cut off 2 yards 8 inches of material quite squarely, fold down the middle, crease, and cut along the crease. This gives two pieces 80 by 15 inches.

Double-stitch tape along the edges of each piece.

Lay the ends of a piece together, tapes inside, and stitch them together half an inch from the edge. Bring a rod up against the stitching on the inside, and calculate where to run a second row of stitching parallel to the first, to form a pocket into which the rod will slip easily but not loosely. (See Fig. 119, *a*.)

Remove the rod and stitch the row.

Now repeat the process at the other end of the folded piece. The positions of the other two rod



pockets must be found by measuring off 15 inches from the inner stitching of those already made. (Be careful to measure in the right direction in each case, so that the short and long sides of the box shall be opposite.) Fold the material *beyond* the 15-inch

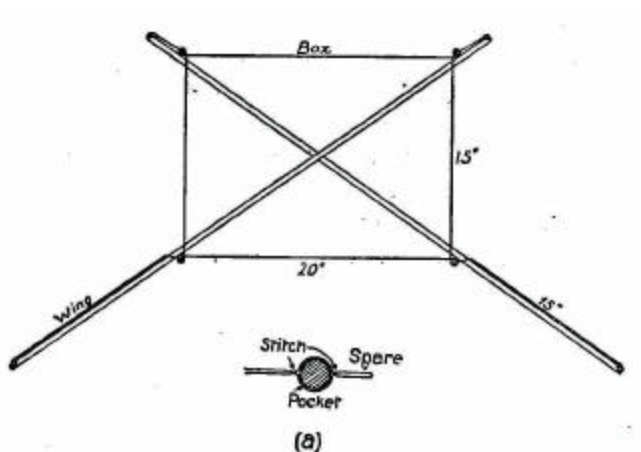

FIG. 119.—Plan of box kite with rear wings.

FIG. 119. -- Plan of box kite with rear wings.

lines to allow for the pockets and the 1/2-inch "spare," and make the two rows of stitching.

Repeat these operations with the second strip of material, and you will have prepared your two boxes, each measuring, inside the pockets, 15 by about 20 inches. (See Fig. 119.)

Now cut out the wings in accordance with the dimensions given in Fig. 120. Each is 47-1/2 inches long and 15 inches across at the broadest point. It is advisable to cut a pattern out of brown paper, and to mark off the material from this, so arranging the pattern that the long 47-1/2-inch side lies on a selvedge. [The edge of a fabric that is woven so that it will not fray or ravel.]

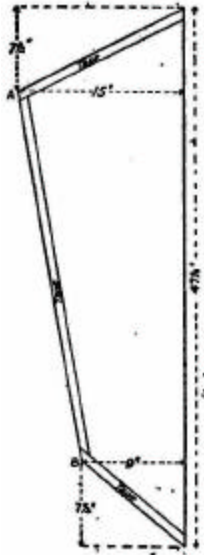

FIG. 120.—Wing for box kite.

FIG. 120. -- Wing for box kite.

Double stitch tapes along the three shorter sides of each wing, finishing off the threads carefully. Then sew the wings to what will be the back corners of the boxes when the kite is in the air--to the "spares" outside the rod pockets of a long side.

Take your needle and some strong thread, and make all corners at the ends of pockets quite secure. This will prevent troublesome splitting when the kite is pulling hard.

Sew a brass ring to each of the four wing angles, AA, BB, at the back, and as many on the front of the spares of the rod pockets diagonally opposite to those to which the wings are attached, halfway up the boxes. These rings are to take the two stretchers in each box.

Slip four rods, after rounding off their ends slightly,

through the pockets of both boxes, and secure them by sewing the ends of the pockets and by the insertion of a few small tacks. These rods will not need to be removed.

The cutting and arrangement of the stretchers and the holes for the same require some thought. Each stretcher lies behind its wing, passes in front of the rod nearest to it, and behind that at the corner diagonally opposite. (See Fig. 119.) The slits through which it is thrust should be strengthened with patches to prevent ripping of the material.

Two persons should hold a box out as squarely as possible while a stretcher is measured. Cut a nick  $\frac{3}{8}$  inch deep in one end of the stretcher, and pass the end through the fabric slits to the ring not on the wing. Pull the wing out, holding it by its ring, and cut the stretcher off 1 inch from the nearest point of the ring. The extra length will allow for the second nick and the tensioning of the material. Now measure off the second stretcher by the first, nick it, and place it in position. If the tension seems excessive, shorten the rods slightly, but do not forget that the fabric will stretch somewhat in use.

Make the stretchers for the second box, and place them in position. The wings ought to be pretty taut

if the adjustments are correct, but should they show a tendency to looseness, a third pair of stretchers of light bamboo may be inserted between the other two,

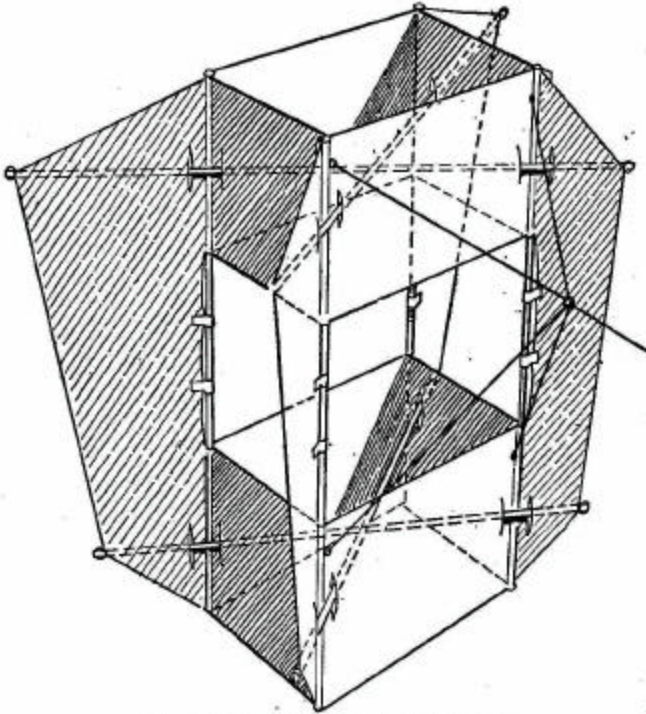

FIG. 121.—Box kite with front and back wings.

FIG. 121. -- Box kite with front and back wings.

being held up to the rods by loops of tape. In order to be able to take up any slackness, the wing end of each stretcher may be allowed to project a couple of

inches, and be attached by string to the near ring, as described on p. 271. The bridle to which the flying string is attached is made up of four parts, two long, two short, paired exactly as regards length. These are attached to eyes screwed into the front rods three inches below the tops of the boxes. Adjustment is made very easy if a small slider is used at the kite end of each part. These sliders should be of bone or some tough wood, and measure 1 inch by 3/8 inch. The forward ends of the bridle are attached to a brass ring from which runs the flying string.

It is advisable to bind the stretchers with strong thread just behind the notches to prevent splitting, and to loosen the stretchers when the kite is not in use, to allow the fabric to retain as much as possible of its elasticity.

The area of the kite affected by wind is about 14 square feet; the total weight, 1-1/2 lb. The cost of material is about 2s.

The experience gained from making the kite described may be used in the construction of a larger kite, six or more feet high, with boxes 30 by 22 by 22 inches, and wings 24 inches wide at the broadest point. If a big lift is required, or it is desired to have a kite usable in very light breezes, a

second pair of wings slightly narrower than those at the back may be attached permanently to the front of the boxes, or be fitted with hooks and eyes for use on occasion only. (Fig. 121.) In the second case two sets of stretchers will be needed.

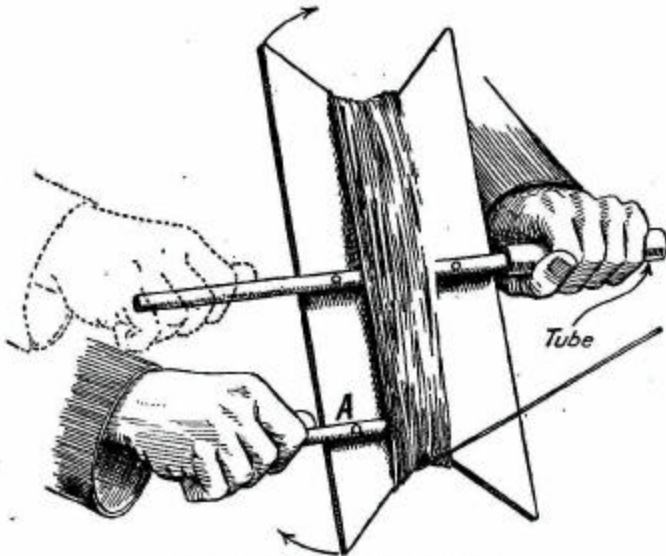

FIG. 122.—Simple string winder for kite.

FIG. 122. -- Simple string winder for kite.

*Note.* -- If all free edges of boxes and wings are cut on the curve, they will be less likely to turn over and flap in the wind; but as the curvature gives extra trouble in cutting out and stitching, the illustrations have been drawn to represent a straight-edged kite.

**Kite Winders.** -- The plain stick which small children flying small kites on short strings find sufficient for winding their twine on is far too primitive a contrivance for dealing with some hundreds of yards, may be, of string. In such circumstances one needs a quick-winding apparatus. A very fairly effective form of winder, suitable for small pulls, is illustrated in Fig. 122.

Select a sound piece of wood, 3/8-inch thick, 5 inches wide, and about 1 foot long. In each end cut a deep V, the sides of which must be carefully smoothed and rounded with chisel and sandpaper. Nail a wooden rod, 15 inches long and slightly flattened where it makes contact, across the centre of the board, taking care not to split the rod, and clinch the ends of the nails securely. The projecting ends of the rods are held in the hands while the string runs out. The projecting piece, A, which must also be well secured, is for winding in. The winding hand must be held somewhat obliquely to the board to clear the spindle. Winding is much less irksome if a piece of tubing is interposed between the spindle and the other hand, which can then maintain a firm grip without exercising a braking effect.

This kind of winder is unsuited for reeling in a

string on which there is a heavy pull, as the hands are working at a great disadvantage at certain points of a revolution.

A far better type is shown in Figs. 123 and 124.

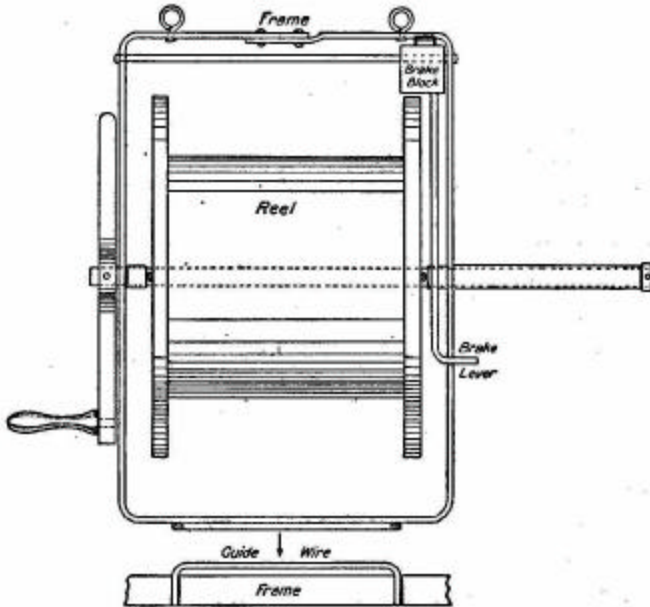

FIG. 123.—Plan of string-winding drum, frame, and brake.

FIG. 123. -- Plan of string-winding drum, frame, and brake.

Select a canister at least 6 inches in diameter, and not more than 6 inches long, with an overlapping lid. Get a turner to make for you a couple of wooden discs,  $\frac{3}{8}$  inch thick, and having a diameter 2 inches



greater than that of the tin. Holes at least  $\frac{3}{8}$  inch across should be bored in the centre of each. Cut holes 1 inch across in the centre of the lid and the bottom of the canister, and nail the lid concentrically to one disc, the canister itself to the other. Then push the lid on the tin and solder them together. This gives you a large reel. For the spindle you will require a piece of brass tubing or steel bar 1 foot long and large enough to make a hard driving fit with the holes in the wood. Before driving it in, make a framework of  $\frac{3}{4}$ -inch strip iron (Fig. 123),  $\frac{3}{32}$  or  $\frac{1}{8}$  inch thick, for the reel to turn in. The width of this framework is 1 inch greater than the length of the reel; its length is twice the diameter of the canister. Rivet or solder the ends together. Halfway along the sides bore holes to fit the spindle.

Make a mark 1 inch from one end of the spindle, a second  $\frac{1}{8}$  inch farther away from the first than the length of the reel. Drill  $\frac{3}{16}$ -inch holes at the marks. Select two wire nails which fit the holes, and remove their heads. Next cut two  $\frac{1}{4}$ -inch pieces off a tube which fits the spindle. The reel, spindle, and framework are now assembled as follows:

Push the end of the spindle which has a hole nearest

to it through one of the framework holes, slip on one of the pieces of tubing, drive the spindle through the reel until half an inch projects; put on the second piece of tubing, and continue driving the spindle till the hole bored in it shows. Then push the nails half-

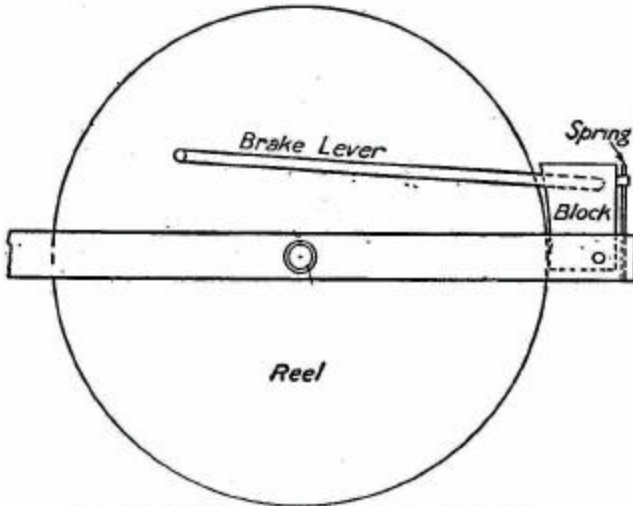

FIG. 124.--End view of string winder, showing brake and lever.

FIG. 124. -- End view of string winder, showing brake and lever.

way through the holes in the spindle, and fix them to the ends of the reel by small staples. A crank is made out of 1/2-inch wood (oak by preference) bored to fit the spindle, to which it must be pinned. A small wooden handle is attached at a suitable distance away. If there is any fear of the wood splitting near the

spindle, it should be bound with fine wire. An alternative method is to file the end of the spindle square, and to solder to it a piece of iron strip in which a square hole has been made to fit the spindle. The crank should be as light as is consistent with sufficient strength, and be balanced so that there shall not be unpleasant vibration when the string runs out fast, and of course it must be attached very securely to the spindle.

What will be the front of the framework must be rounded off on the top edge, which has a wire guide running parallel to it (Fig. 123) to direct the string on to the reel; and into the back are riveted a couple of eyes, to which are attached the ends of a cord passing round the body, or some stationary object.

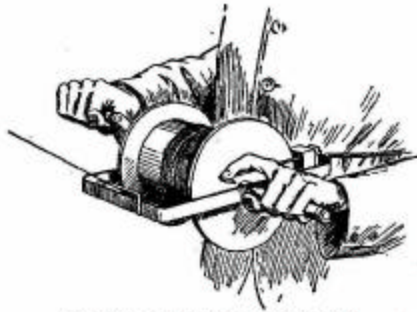

FIG. 125.—String winder in operation.

FIG. 125. -- String winder in operation.

A pin should be provided to push into a hole at one end of the reel and lock the reel by striking the framework, and it will be found a great convenience to have a brake for controlling the reel when the kite

is rising. Such a brake is easily fitted to the side of the frame, to act on the left end of the reel when a lever is depressed by the fingers. There should be a spring to keep it off the reel when it is not required. The diagrams show where the brake and brake lever are situated.

*Note.* -- To obtain great elevations a fine wire (piano wire  $1/32$  inch in diameter) is generally used, but to protect the user against electric shocks the wire must be connected with an "earthed" terminal, on the principle of the lightning conductor.

**XXIV.**  
**PAPER GLIDERS.**

In this chapter are brought to your notice some patterns of paper gliders which, if made and handled carefully, prove very satisfactory. Gliders are sensitive and "moody" things, so that first experiments may be attended by failure; but a little persistence will bring its reward, and at the end of a few hours you will, unless very unlucky, be the possessor of a good specimen or two.

The three distinguishing features of a good glider are stability, straightness of flight, and a small gliding angle. If the last is as low as 1 in 10, so that the model falls but 1 foot vertically while progressing 10 feet horizontally, the glider is one to be proud of.

**Materials.** -- The materials needed for the gliders to be described are moderately stout paper -- cream-laid notepaper is somewhat heavy for the purpose -- and a little sealing wax or thin sheet metal for weighting.

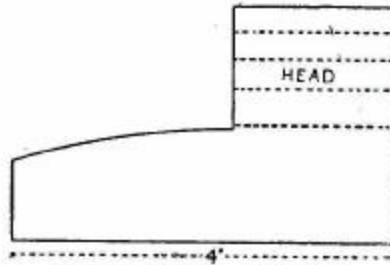

FIG. 126.—Paper glider: Model "A."

FIG. 126. -- Paper glider: Model "A."

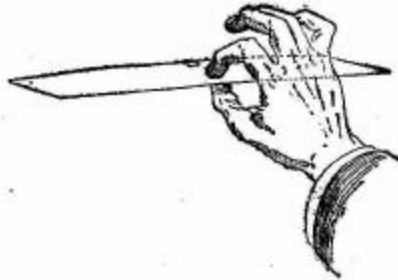

FIG. 127.—How to launch Model "A."

FIG. 127. -- How to launch Model "A."

**Model "A."** -- Double a piece of paper 8 inches long and 2-1/2 inches wide, and cut out, through both folds, the shape shown in Fig. 126. Flatten the piece and fold the "head" inwards four times on the side away from the direction in which the paper was folded before being cut out. Flatten the folds and fix to the centre a little clip formed by doubling a piece of thin metal 3/16 by 1/2 inch. Make certain that the wings are quite flat, and then, holding the glider between thumb and first finger, as shown in Fig. 127, push it off gently. If the balance is right, it will fly quite a long way with an undulating motion. If too heavy in front, it will dive; if too light, it will rise suddenly and slip backwards to the ground. The clip or the amount of paper in the head must

be modified accordingly. This type is extraordinarily efficient if the dimensions, weighting, and shape are correct, and one of the easiest possible to make.

**Model "B."** -- The next model (Fig. 128), suggesting by its shape the Langley steam-driven aeroplane, has two sets of wings tandem. Double a piece of paper and cut out of both folds simultaneously a figure of the shape indicated by the solid lines in the diagram. The portion A is square, and forms the head weight; B indicates the front planes, C the rear planes. Bend the upper fold of each pair into the positions B1, C1, marked by dotted lines. Their front edges make less than a right angle with the keel, to ensure the wings slanting slightly upwards towards the front when expanded.

The model is now turned over, and the other wings are folded exactly on top of their respective fellows. Then the halves of the head are folded twice inwards, to bring the paper into as compact a form as possible. It remains to open out the wings at right angles to the keel, and then raise their tips slightly so that the two planes of a pair shall make what is called a "dihedral" angle with one another.

Before launching, look at your model endways and make sure that the rear planes are exactly in line

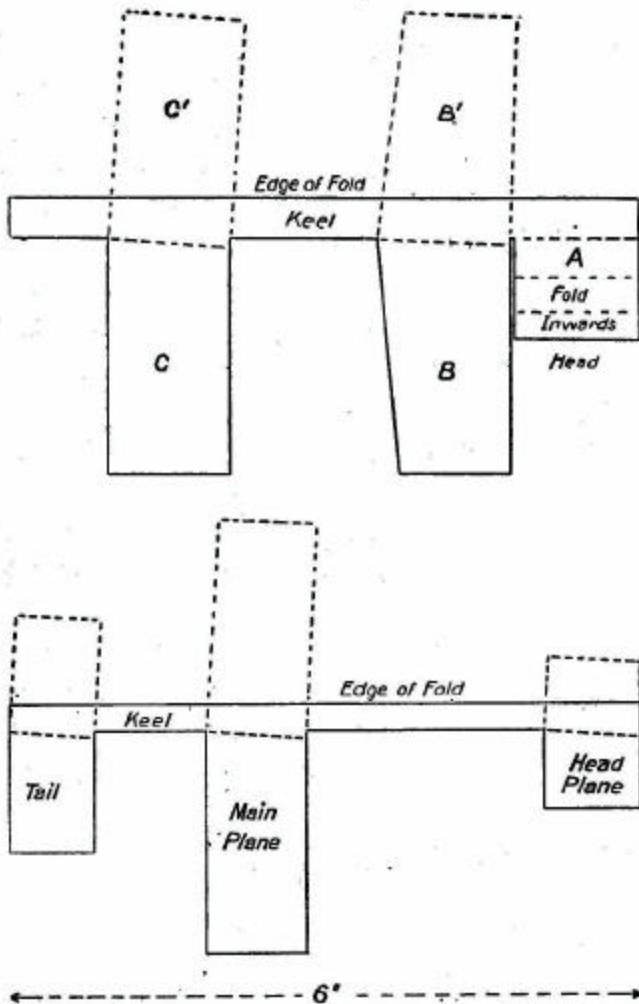

FIG. 128.—Details of paper gliders: Model "B" above, Model "C" below.

FIG. 128. -- Details of paper gliders: Model "B" above, Model "C" below.



with those in front. It is essential that they should be so for straight flight. Then grip the keel at its centre between finger and thumb and launch gently. Mark how your glider behaves. If it plunges persistently, trim off a very little of the head. If, on the contrary, it settles almost vertically, weight must be added in front. The position of the weight is soon found by sliding a metal clip along the keel until a good result is obtained.

Note that if the leading edges of the front wings are bent slightly downwards the glider may fly much better than before.

A good specimen of this type is so stable that if launched upside down it will right itself immediately and make a normal flight.

**Model "C."** -- This is cut out of doubled paper according to the solid lines of Fig. 128. The three sets of planes are bent back in the manner already described, but the front planes are given a somewhat steeper angle than the others. This type is very stable and very fairly efficient.

**General Remarks.** -- Always pick up a glider by the keel or middle, not by one of the wings, as a very little distortion will give trouble.

The merits of a glider depend on length, and on

straightness of flight; so in competition the launching height should be limited by a string stretched across the room, say 6 feet above the floor. If the room be too short for a glider to finish its flight, the elevation at which it strikes the wall is the measure of its efficiency.

Out-of-door flights are impracticable with these very frail models when there is the slightest breeze blowing. On a perfectly calm day, however, much better fun can be got out of doors than in, owing to the greater space available. A good glider launched from a second-floor window facing a large lawn should travel many yards before coming to grass.

Large gliders of the types detailed above can be made of very stout paper stiffened with slips of cane or bamboo; but the time they demand in construction might perhaps be more profitably spent on a power-driven aeroplane such as forms the subject of the next chapter.

**XXV.****A SELF-LAUNCHING MODEL AEROPLANE.**

By V. E. Johnson, M.A.

This article deals not with a scale model -- a small copy of some full-sized machine -- but with one designed for actual flight; with one not specially intended to create records either of length or duration, but which, although small details must perforce be omitted, does along its main lines approximate to the "real thing."

Partly for this reason, and partly because it proves a far more interesting machine, we choose a model able to rise from the ground under its own power and make a good flight after rising, assuming the instructions which we give to have been carefully carried out. It is perhaps hardly necessary to add that such a machine can always be launched by hand when desired.

Before entering into special details we may note some broad principles which must be taken into account if success is to attend our efforts.

**Important Points.** -- It is absolutely essential that the *weight be kept down* as much as possible. It is quite a mistake to suppose that weight necessarily means strength. On the contrary, it may actually be a cause of weakness if employed in the wrong place and in the wrong way. The heavier the machine, the more serious the damage done in the event of a bad landing. One of the best and easiest ways of ensuring lightness is to let the model be of very simple construction. Such a model is easier to build and more efficient when constructed than one of more complicated design. *Weigh* every part of your model as you construct it, and do not be content until all symmetrically arranged parts which should weigh the same not only *look* alike but do actually *balance one another*. (*Note.* -- The writer always works out the various parts of his models in grammes, not ounces.) If a sufficiently strong propeller bearing weighing only half a gramme can be employed, so much the better, as you have more margin left for some other part of the model in which it would be inadvisable to cut down the weight to a very fine limit.

**Details.** -- To pass now to details, we have four distinct parts to deal with:--

1. The *framework*, or fuselage.
2. The *supporting surfaces*, consisting of the main plane, or aerofoil, behind, and the elevator in front.
3. The *propellers*.
4. The *motor*, in this case two long skeins of rubber; long, because we wish to be able to give our motor many turns, from 700 to, say, 1,000 as a limit, so that the duration of flight may be considerable.



**FIG. 129.**—Sections of backbone for model aeroplane.

FIG. 129.-Sections of backbone for model aeroplane.

**The Backbone.** -- For the backbone or central rod take a piece of pitch pine or satin walnut 52 inches long,  $\frac{5}{8}$  inch deep, and  $\frac{1}{2}$  inch broad, and plane it down carefully until it has a T-shaped section, as shown in Fig. 129, and the thickness is not anywhere more than  $\frac{1}{8}$  inch. It is quite possible to reduce the thickness to even  $\frac{1}{16}$  inch and still have a sufficient reserve of strength to withstand

the pull of 28 strands of 1/16-inch rubber wound up 1,000 times; but such a course is not advisable unless you are a skilful planer and have had some experience in model-making.

If you find the construction of the T-shaped rod too difficult, two courses are open--

- (1) to get a carpenter to do the job for you, or
- (2) to give the rod the triangular section shown in Fig. 129, each side of the equilateral triangle being half an inch long.

The top of the T or the base

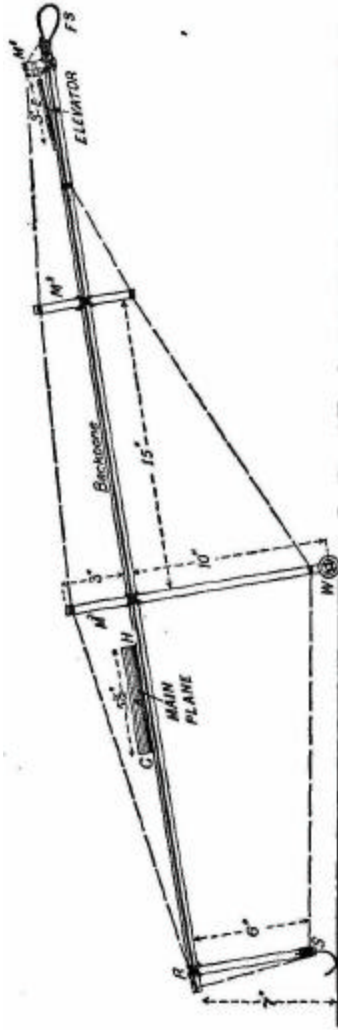

FIG. 130.—Side elevation of model aeroplanes.

FIG. 130 -- Side elevation of model aeroplane

of the triangle, as the case may be, is used uppermost. This rod must be pierced in three places for the vertical masts employed in the bracing of the rod, trussing the main plane, and adjusting the elevator. These are spaced out in Fig. 130, which shows a side elevation of the model. Their sectional dimensions are 1/16 by 1/4 inch; their respective lengths are given in Fig. 130. Round the front edges and sharpen the rear.

In Fig. 130 is shown the correct attitude or standing pose necessary to make the model rise quickly and sweep boldly up into the air without skimming the ground for some 10 to 20 yards as so many models do. E is the elevator (7 by 3 inches); A the main plane (5-1/2 by 29 inches); W the wheels; and RS the rear skid, terminating in a piece of hooked steel wire. The vertical bracing of these masts is indicated. The best material to use for the purpose is Japanese silk gut, which is very light and strong. To brace, drill a small, neat hole in the mast and rod where necessary, pass through, and tie. Do the same with each one.

To return to the central mast, which must also form the chassis. This is double and opened out beneath as shown in Fig. 131, yz being a piece similar

to the sides, which completes, the triangle  $xyz$  and gives the necessary rigidity.

Attach this piece by first binding to its extremities two strips of aluminium, or by preference very thin tinned iron, T1 and T2. Bend to shape and bind to  $xy$ ,  $xz$  as shown in Fig. 131.

**The Wheels and Chassis.**

-- WW are the two wheels on which the model runs. They are made of hollow brass curtain rings, 1 inch in diameter, such as can be bought at four a penny. For spokes, solder two strips of thin tinned iron to the rings, using as little solder as possible. (Fig. 132.) To connect these wheels with the chassis, first bind to the lower ends of  $xy$ ,  $xz$  two strips of thin tinned iron, T3 and T4, after drilling in them two holes of sufficient size to allow a piece of steel wire of "bonnet pin" gauge to pass

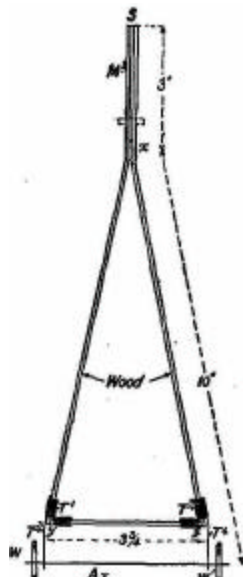

FIG. 131.—Front elevation of chassis.

FIG. 131. -- Front elevation of chassis.

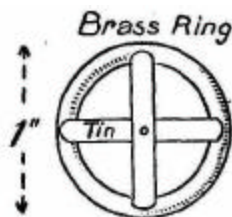

FIG. 132.—Wheel for model aeroplane chassis.

FIG. 132.-Wheel for model aeroplane chassis.



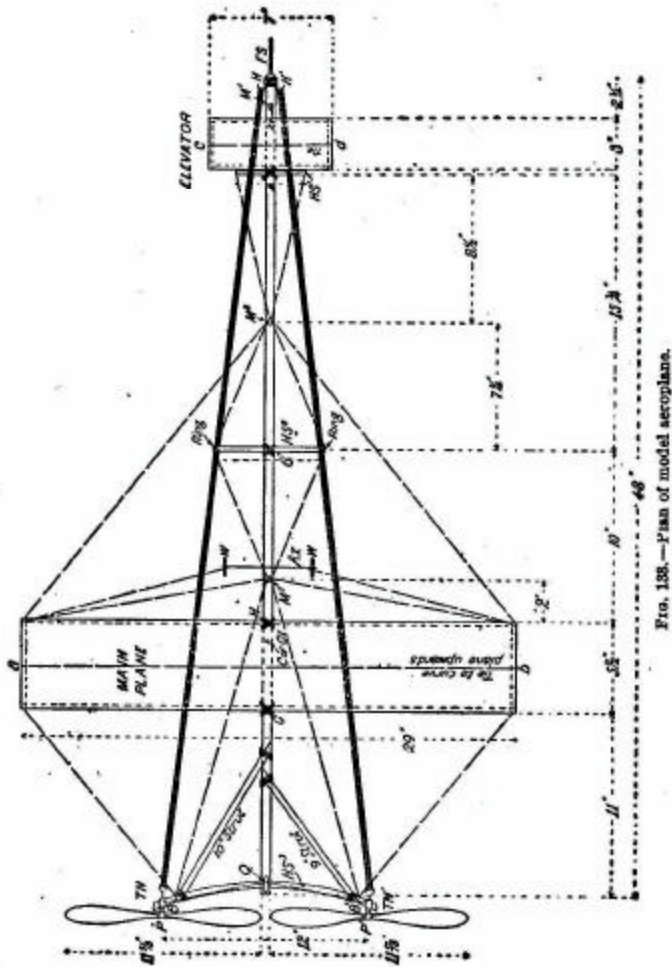

FIG. 133.—Plan of model aeroplane.

FIG. 133. -- Plan of model aeroplane.

freely, but not loosely, through them. Soften the wire by making it red hot and allowing it to cool slowly, and solder one end of this wire (which must be quite straight and 5-1/4 inches long) to the centre of the cross pieces or spokes of one wheel. Pass the axle through the holes in the ends of *xy*, *xz*, and solder on the other wheel. Your chassis is then finished.

The rear skid (RS in Fig. 130) is attached to the central rod by gluing, and drilling a hole through both parts and inserting a *wooden* peg; or the upright may be mortised in. On no account use nail, tack, or screw. Attach the vertical masts and the horizontal ones about to be described by gluing and binding lightly with thread, or by neatly glued strips of the Hart's fabric used for the planes.

**Horizontal Spars, etc.** -- To consider now the horizontal section or part plan of the model, from which, to avoid confusion, details of most vertical parts are omitted. Referring to Fig. 133, it will be seen that we have three horizontal masts or spars--HS1, 4 inches; HS2, 6 inches; and HS3, slightly over 12 inches long. The last is well steamed, slightly curved and left to dry while confined in such a manner as to conform to the required shape. It should so remain

at least twenty-four hours before being fixed to the model. All the spars are attached by glue and neat cross bindings. If the central rod be of triangular instead of T section, the join can be made more neatly. The same remarks apply to the two 9 and 10 inch struts at the propeller end of the rod, which have to withstand the pull of the rubber motor on PPI. These two pieces will have a maximum strength and minimum weight if of the T section used for the rod. If the work is done carefully, 1/4 inch each way will be sufficient.

**Main Plane and Elevator.** -- The framework of each plane is simply four strips of satin walnut or other suitable wood, 1/4 inch broad and 1/16 inch or even less in thickness for the main plane, and about 1/16 by 1/16 inch for the elevator. These strips are first glued together at the corners and left to set. The fabric (Hart's fabric or some similar very light material) is then glued on fairly tight--that is, just sufficiently so to get rid of all creases. The main plane is then fixed *flat* on to the top of the central rod by gluing and cross binding at G and H. (A better but rather more difficult plan is to fasten the rectangular frame on first and then apply the fabric.) The same course is followed in dealing with the elevator, which is

fixed, however, not to the rod, but to the 4-inch horizontal spar, HS1, just behind it, in such a manner as to have a slight hinge movement at the back. This operation presents no difficulty, and may be effected in a variety of ways. To *set* the elevator, use is made of the short vertical mast, M1. A small hole is pierced in the front side of the elevator frame at Z, and through this a piece of thin, soft iron wire is pushed, bent round the spar, and tied. The other end of the wire is taken forward and wrapped three or four times round the mast M1, which should have several notches in its front edge, to assist the setting of the elevator at different angles. Pull the wire tight, so that the elevator shall maintain a constant angle when once set. H H1 is a piece of 25 to 30 gauge wire bent as shown and fastened by binding. It passes round the front of the rod, in which a little notch should be cut, so as to be able to resist the pull of the twin rubber motors, the two skeins of which are stretched between H H1 and the hooks formed on the propeller spindles. If all these hooks are covered with cycle valve tubing the rubber will last much longer. The rubber skeins pass through two little light wire rings fastened to the underside ends of HS2. (Fig. 133.)

The front skid or protector, FS, is made out of a piece of thin, round, jointless cane, some 9 inches in length, bent round as shown in Fig. 134, in which A B represents the front piece of the T-shaped rod and  $x y z a$  the cane skid; the portion  $x y$  passing on the near side of the vertical part of the T, and  $z a$  on the far side of the same. At E and F thread is bound right round the rod. Should the nose of the machine strike the ground, the loop of cane will be driven along the underside of the rod and the shock be minimized. So adjust matters that the skid slides fairly stiff. Note that the whole of the cane is on the *under* side of the top bar of the T.

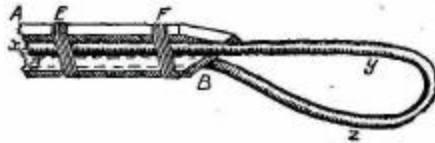

FIG. 134.—Front skid and attachment to backbone.

FIG. 134. -- Front skid and attachment to backbone.

**Bearings.** -- We have still to deal with the propellers and their bearings. The last, TN and TN1 (Fig. 133), are simply two tiny pieces of tin about half a gramme in weight, bent round the propeller spar HS3 at B and B1. Take a strip of thin tin 1/4 inch wide and of sufficient length to go completely round the spar (which is 1/4 by 1/8 inch) and overlap slightly. Solder the ends together, using a minimum amount of solder.

Now bore two small holes through wood and tin from rear to front, being careful to go through the centre. The hole must be just large enough to allow the propeller axle to run freely, but not loosely, in it. Primitive though such a bearing may seem, it answers admirably in practice. The wood drills out or is soon worn more than the iron, and the axle runs quite freely. The pull of the motor is thus directed through the thin curved spar at a point where the resistance is greatest--a very important matter in model aeroplane construction. To strengthen this spar further against torsional forces, run gut ties from B and B1 down to the bottom of the rear vertical skid post; and from B to B1 also pass a piece of *very thin* piano wire, soldered to the tin strips over a little wooden bridge, Q, like a violin bridge, on the top of the central rod, to keep it quite taut.



FIG. 135.  
"Centrale"  
wooden propeller.

FIG. 135 -- "Centrale" wooden propeller.

**Propellers.** -- To turn now to the propellers. Unless the reader has already had fair experience in making model propellers, he should purchase a couple, one right-handed and one left-handed, as they have to revolve in opposite directions. It would be quite impossible to give in the compass of this article such

directions as would enable a novice to make a really efficient propeller, and it *must* be efficient for even a decent flight with a self-launching model. The diameter of the two propellers should be about 11-1/2 to 11-3/4 inches, with a pitch angle at the extremities of about 25 to 30 degrees as a limit. The "centrale" type (Fig. 135) is to be preferred. Such propellers can be procured at Messrs. A. W. Gamage, Ltd., Holborn, E.C.; Messrs. T. W. K. Clarke and Co., Kingston-on-Thames; and elsewhere.

For the particular machine which we are considering, the total weight of the two propellers, including axle and hook for holding the rubber, should not exceed 3/4 oz. This means considerable labour in cutting and sandpapering away part of the boss, which is always made much too large in propellers of this size. It is wonderful what can be done by care and patience. The writer has in more than one case reduced the weight of a propeller by more than one-half by such means, and has yet left sufficient strength.

The combined axle and hook should be made as follows:--Take a piece of thin steel wire, sharpen one end, and bend it as shown at C (Fig. 136). Pass the end B through a tight-fitting hole in the centre of

the small boss of the propeller, and drive C into the wood. Solder a tiny piece of 1/8-inch brass tubing to the wire axle at A, close up to the rubber hook side of the propeller, and file quite smooth. The only things now left to do are to bend the wire into the form of a hook (as shown by the dotted line), and to cover this hook, as already advised, with a piece of valve tubing to prevent fraying the rubber skeins.

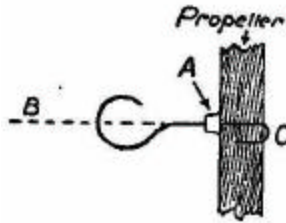

FIG. 136.—Axle and hook for propeller.

FIG. 136. -- Axle and hook for propeller.

**Weight.** -- The weight of a model with a T-shaped central rod 1/16 inch thick should be 4-1/2 oz. Probably it will be more than this--as a maximum let us fix 6 oz.--although 4-1/2 oz. is quite possible, as the writer has proved in actual practice. In any case the centre of gravity of the machine without the rubber motor should be situated 1 inch behind the front or entering edge of the main plane. When the rubber motor (14 strands of 1/16-inch rubber for each propeller, total weight 2 oz.) is in position, the centre of gravity will be further forward, in front of the main plane. The amount of rubber mentioned is for a total weight of 6-1/2 oz. If the weight of the model alone be 6 oz., you will probably have to use 16 strands, which again adds to the weight, and makes one travel in a



vicious circle. Therefore I lay emphasis on the advice, *Keep down the weight.*

The front edge of the elevator should be set about  $\frac{3}{8}$  inch higher than the back, and the model be tried first as a glider, with the rubber and propellers in position. If it glides satisfactorily, wind up the motor, say 500 turns, and launch by hand. When a good flight has been obtained, and the correct angle of the elevator has been determined, place the model on a strip of linoleum, wind up, and release the propellers. The model should rise in its own length and remain in the air (if wound up 900 turns) at least three quarters of a minute. Choose a calm day if possible. If a wind blows, let the model face the breeze. Remember that the model flies high, and select a wide open space. Do not push the model forward; just release the propellers, held one in each hand near the boss by the fingers and thumb. As a *lubricant* for the rubber use *pure* glycerine. It is advisable to employ a geared-up mechanical winder, since to make 1,800 turns with the fingers is rather fatiguing and very tedious.

Simple as this model may seem in design, one built by the writer on exactly the lines given has met the most famous flying models of the day in open competition and proved successful against them.

**XXVI.**  
**APPARATUS FOR SIMPLE SCIENTIFIC**  
**EXPERIMENTS.**

**Colour Discs for the Gramophone.** -- The gramophone, by virtue of its table revolving at a controllable speed, comes in useful for a series of optical experiments made with coloured discs bearing designs of different kinds.

The material needed for these discs is cardboard, covered with white paper on one side, or the Bristol board used by artists. The discs on which the designs are drawn should be made as large as the gramophone table will take conveniently, so as to be viewed by a number of people at once. To encourage readers who do not possess a gramophone, it may be pointed out that a gramophone, is merely a convenience, and not indispensable for turning the discs, which may be revolved on a sharpened pencil or any other spindle with pointed ends.

**The Vanishing Spirals**  
(Fig. 137). -- This design, if spun slowly in a clockwise direction, gives one the impression that the lines all move in towards the centre. If the disc is turned in an anti-clockwise direction, the lines seem to move towards the circumference and disappear. To get the proper effect the gaze should be fixed and not attempt to follow the lines round.



FIG. 137.

FIG. 137.

**The Rolling Circles.** --  
Figs. 138 and 139 are variations of the same idea. In Fig. 138 two large circles are described cutting one another and enclosing a smaller circle concentric with the disc.

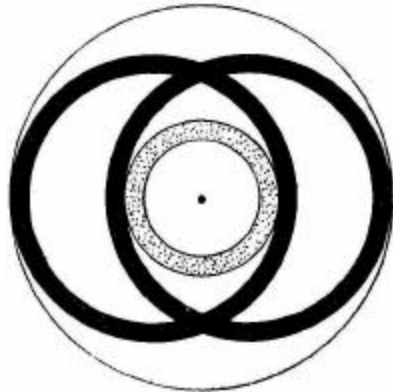

FIG. 138.

FIG. 138.

When spun at a certain rate the larger circles will appear to run independently round the small. The effect is heightened if the circles are given different colours. If black only is used for the large circles, the eyes should be kept half closed.

In Fig. 139 two pairs of circles are described about two centres, neither of which is the centre of the disc. The pairs appear to roll independently.

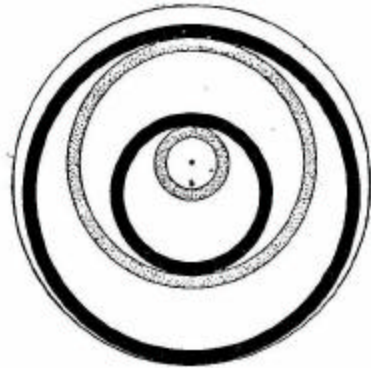

FIG. 139.

FIG. 139.

**The Wriggling Line** (Fig. 140). -- If this design is revolved at a low speed and the eye is fixed on a point, the white (or coloured) line will seem to undulate in a very extraordinary manner. The line is made up



FIG. 140.

FIG. 140.

of arcs of circles, and as the marking out is somewhat of a geometrical problem, a diagram (Fig. 141) is added to show how it is done. The dotted curves are those parts of the circles which do not enter into the design.

Begin by marking out the big circle A for the disc. The circumference of this is divided into six equal parts (chord equal to radius), and through the points of division are drawn the six lines from the centre. Describe circles *aaa*, each half the diameter of A. The circles *bbb* are then drawn from centres on the lines RRR, and with the same radius as *aaa*., The same centres are used for describing the circles *a1 a1 a1* and *b1 b1 b1*, parts of which form the inner boundary of the line. The background should be blackened and the belt left white or be painted some bright colour.

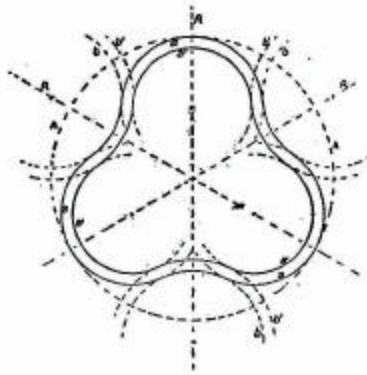

FIG. 141.

FIG. 141.

Another optical illusion is afforded by Fig. 142. Two sets of circles are described about different centres, and the crescent-shaped areas between them coloured, the remainder of the disc being left white. The disc is revolved about the centre of the white areas, and one gets the impression that the coloured parts are portions of separate discs separated by white discs.



FIG. 142.

FIG. 142.

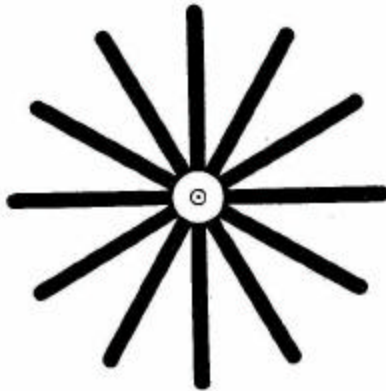

FIG. 143.

FIG. 143.

**The Magic Spokes (Fig. 143).** -- Place a design like this on the gramophone and let it turn at high speed. The radial lines seem but a blur. Now punch a hole one-eighth of an inch in diameter in a piece of blackened card, and, standing well away from the

gramophone, apply your eye to the hole and move the card quickly to and fro. The extreme briefness of the glimpses obtained of the moving lines seems to rob them of motion, or even make them appear to be moving in the direction contrary to the actual. Instead of a single hole, one may use a number of holes punched at equal intervals round a circle, and revolve the card on the centre. If a certain speed be maintained, the spokes will appear motionless.

The substitution of a long narrow slit for a circular hole gives other effects.

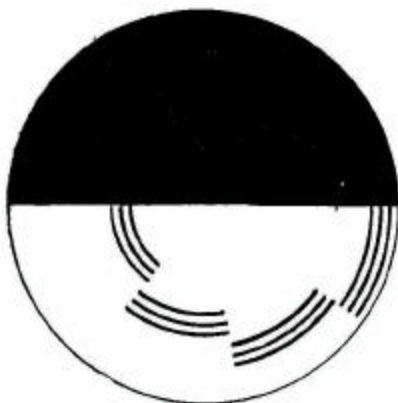

FIG. 144.

**A Colour Top.** -- Cut a 4-inch disc out of white cardboard and blacken one-half with Indian ink. On the other half draw four series of concentric black lines, as shown in Fig. 144. If the disc is mounted on a knitting needle and spun in a horizontal plane, the black lines will appear of different colours. A clockwise rotation makes the outermost lines appear

a greenish blue, those nearest the centre a dark red, and the intermediate groups yellow and green. A reversal of the motion reverses the order of the colours, the red lines now being farthest from the centre. The experiment is generally most successful by artificial light, which contains a larger proportion of red and yellow rays than does sunlight. The speed at which the top revolves affects the result considerably. It should be kept moderate, any excess tending to neutralize the colours.

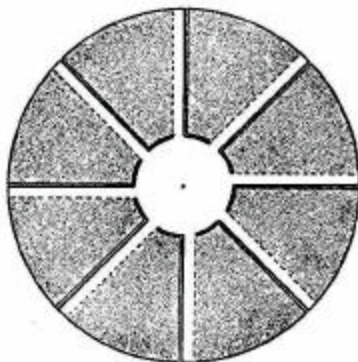

FIG. 145.

**The Magic Windmill.** -- Mark a circle 2-1/2 inches in diameter on a piece of notepaper, resting the centre leg [of the compass] so lightly that it dents without piercing the paper. With the same centre describe a 3/4-inch circle. Join the circles by eight equally spaced radial lines, and an eighth of an inch away draw dotted parallel lines, all on the same side of their fellow lines in order of rotation. Cut out along the large circle, and then with a sharp knife



follow the lines shown double in Fig. 145. This gives eight little vanes, each of which must be bent upwards to approximately the same angle round a flat ruler held with an edge on the dotted line. Next make a dent with a lead pencil at the exact centre on the vane side, and revolve the pencil until the dent is well polished.



FIG. 146.

FIG. 146.

Hold a pin, point upwards, in the right hand, and with the left centre the mill, vanes pointing downwards, on the pin (Fig. 146). The mill will immediately commence to revolve at a steady pace, and will continue to do so indefinitely; though, if the head of the pin be stuck in, say, a piece of bread, no motion will occur. The secret is that the heat of the hand causes a very slight upward current of warmed air, which is sufficient to make the very delicately poised windmill revolve.

**A Pneumatic Puzzle.** -- For the very simple apparatus illustrated by Fig. 147 one needs only half a cotton reel, three pins, and a piece of glass or metal tubing which fits the hole in the reel. Adjust a halfpenny centrally over the hole and stick the pins into the reel at three equidistant points, so that they do not quite touch the coin, and with their ends sloping slightly outwards to allow the halfpenny to fall away.

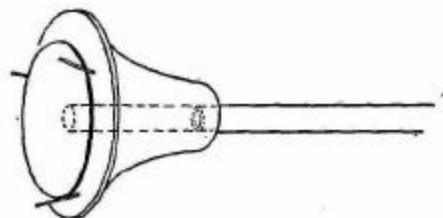

FIG. 147.--Apparatus for illustrating an apparent scientific paradox.

FIG. 147. -- Apparatus for illustrating an apparent scientific paradox.

Press the coin against the reel and blow hard through the tube. One would expect the coin to fall; but, on the contrary, the harder you blow the tighter will it stick, even if the reel be pointed downwards. Only when you stop blowing will it fall to the floor.

This is a very interesting experiment, and will mystify onlookers who do not understand the reason for the apparent paradox, which is this. The air blown through the reel strikes a very limited part of the nearer side of the halfpenny. In order to escape, it has to make a right-angle turn and pass between coin and reel, and, while travelling in this

direction, loses most of its repulsive force. The result is that the total pressure on the underside of the coin, plus the effect of gravity, is exactly balanced by the atmospheric pressure on the outside, and the coin remains at that distance from the reel which gives equilibrium of forces. When one stops blowing, the air pressure on both sides is the same, and gravity makes the coin fall away.

The function of the pins is merely to keep the halfpenny centred on the hole. If steam is used instead of human breath, a considerable weight may be hung from the disc without dislodging it.

**The Magic Swingers.** -- The easily made toy illustrated on p. 321 is much more interesting than would appear from the mere picture, as it demonstrates a very striking physical phenomenon, the transference of energy. If two pendulums are hung close together from a flexible support and swung, their movements influence one another in a somewhat remarkable way--the swing of the one increasing as that of the other dies down, until a certain point is reached, after which the process is reversed, and the "dying" or "dead" pendulum commences to come to life again at the expense of the other. This alternation is

repeated over and over again, until all the energy of both pendulums is exhausted.

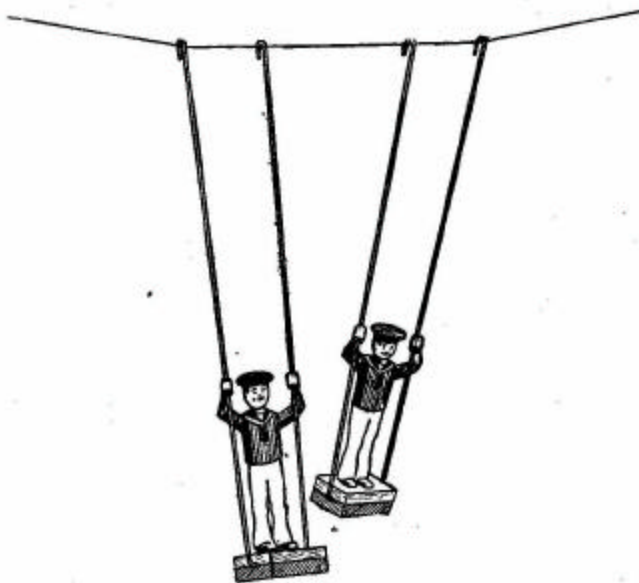

FIG. 148.—Magic pendulums.

FIG. 148.-Magic pendulums.

To make the experiment more attractive, we substitute for the simplest possible pendulums--weights at the end of strings--small swings, each containing a figure sitting or standing on a seat, to the underside of which is attached a quarter of a pound of lead. To prevent the swings twisting, they are best made of strong wire bent as shown in Fig. 148,

care being taken that the sides are of equal length, so that both hooks may press equally on the strings. Eighteen inches is a good length. The longer the swing, and the heavier the weight, the longer will the experiment last.

The swings are hung, six inches apart, from a stout string stretched tightly between two well-weighted chairs or between two fixed points. The string should be at least 4 feet long.

With two equally long and equally weighted pendulums, the three following experiments may be carried out:--

1. Let one, A, start from rest. The other, B will gradually die, and A swing to and fro more and more violently, till B at last comes to a dead stop. Then A will die and B in turn get up speed. The energy originally imparted to B is thus transferred through the string from one pendulum to the other an indefinite number of times, with a slight loss at every alternation, until it is finally exhausted by friction.

2. Swing them in *opposite* directions, but start A from a higher point than B. They will each alternately lose and gain motion, but will never come to rest, and will continue to swing in opposite directions--that is, while A swings north or east B will be swinging south or west, and *vice versa*.

3. Start them both in the *same* direction, but one from a higher point than the other. There will be the same transference of energy as in (2), but neither will come to rest between alternations, and they will always swing in the *same* direction.

*Unequal Lengths.* -- If for one of the original pendulums we substitute one a couple of inches *longer* than the other, but of the *same weight*, the same set of three experiments will provide six variations among them, as in each case either the longer or the shorter may be started first or given the longer initial swing, as the case may be. The results are interesting throughout, and should be noted.

*Three or more Pendulums.* -- If the number of pendulums be increased to three or more, the length of all being the same, a fresh field for observation is opened. With an increase of number a decrease in the individual weighting is advisable, to prevent an undue sagging of the string.

In conclusion, we may remark that a strong chain stretched between two trees and a suitable supply of rope will enable the reader and his friends to carry out all the experiments on a life-size scale.

**A Smoke-ring Apparatus.** -- Get a large tin of the self-opening kind and cut a hole 2 inches across in the bottom. Then make a neat circular hole  $1\frac{1}{4}$  inches in diameter in the centre of a paper disc somewhat smaller than the bottom of the tin, to which it is pasted firmly on the outside.

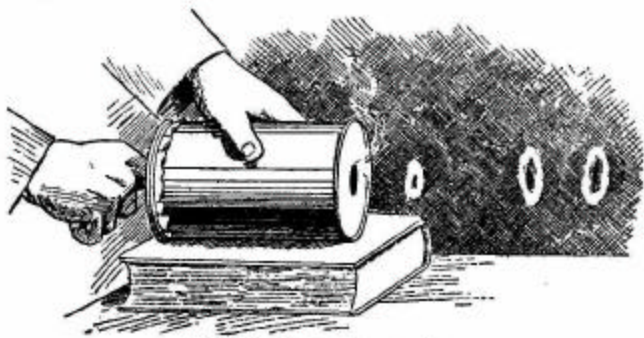

FIG. 149.—Smoke-ring apparatus.

FIG. 149. -- Smoke-ring apparatus.

The other end--from which the lid is removed--must be covered with a piece of sheet rubber stretched fairly tight and secured to the tin by string passed over it behind the rim. An old cycle or motor car air tube, according to the size of the tin, will furnish the rubber needed; but new material, will cost only a few pence (Fig. 149).

A dense smoke is produced by putting in the tin two small rolls of blotting paper, one soaked in

hydrochloric acid, the other in strong ammonia. The rolls should not touch. To reduce corrosion of the tin by the acid, the inside should be lined with thin card.

A ring of smoke is projected from the hole in the card if the rubber diaphragm is pushed inwards. A slow, steady push makes a fat, lazy ring come out; a smart tap a thinner one, moving much faster. Absolutely still air is needed for the best effects, as

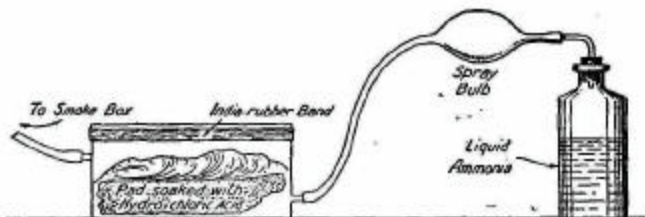

FIG. 150.—Smoke-making apparatus.

FIG. 150. -- Smoke-making apparatus.

draughts make the rings lose shape very quickly and move erratically. Given good conditions, a lot of fun can be got out of the rings by shooting one through another which has expanded somewhat, or by destroying one by striking it with another, or by extinguishing a candle set up at a distance, and so on. The experimenter should notice how a vortex ring rotates in itself while moving forward, like a rubber ring being rolled along a stick.



A continuous supply of smoke can be provided by the apparatus shown in Fig. 150. The bulb of a scent spray is needed to force ammonia gas through a box, made air-tight by a rubber band round the lid, in which is a pad soaked with hydrochloric acid. The smoke formed in this box is expelled through a pipe into the ring-making box.

*Caution.* -- When dealing with hydrochloric acid, take great care not to get it on your skin or clothes, as it is a very strong corrosive.

**XXVII.**  
**A RAIN-GAUGE.**

The systematic measurement of rainfall is one of those pursuits which prove more interesting in the doing than in the prospect. It enables us to compare one season or one year with another; tells us what the weather has been while we slept; affords a little mild excitement when thunderstorms are about; and compensates to a limited extent for the disadvantages of a wet day.

The general practice is to examine the gauge daily (say at 10 a.m.); to measure the water, if any, collected during the previous twenty-four hours; and to enter the record at once. Gauges are made which record automatically the rainfall on a chart or dial, but these are necessarily much more expensive than those which merely catch the water for measurement.

This last class, to which our attention will be confined chiefly, all include two principal parts--a metal

receiver and a graduated glass measure, of much smaller diameter than the receiver, so that the divisions representing hundredths of an inch may be far enough apart to be distinguishable. It is evident that the smaller the area of the measure is, relatively to that of the receiver, the more widely spaced will the graduation marks of the measure be, and the more exact the readings obtained.

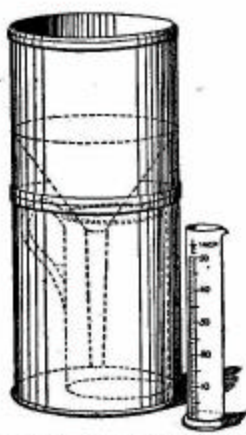

FIG. 151.—Standard rain-gauge.

FIG. 151. -- Standard rain-gauge.

The gauge most commonly used is that shown in Fig. 151. It consists of an upper cylindrical part, usually 5 or 8 inches in diameter, at the inside of the rim, with its bottom closed by a funnel. The lower cylindrical part holds a glass catcher into which the funnel delivers the water for storage until the time when it will be measured in a graduated glass. The upper part makes a good fit with the lower, in order to reduce evaporation to a minimum.

Such a gauge can be bought for half a guinea or so, but one which, if carefully made, will prove approximately accurate, can be constructed at very

small expense. One needs, in the first place, a cylindrical tin, or, better still, a piece of brass tubing, about 5 inches high and not less than 3 inches in diameter. (Experiments have proved that the larger the area of the receiver the more accurate are the results.) The second requisite is a piece of stout glass tubing having an internal diameter not more than one-quarter that of the receiver. This is to serve as measuring glass.

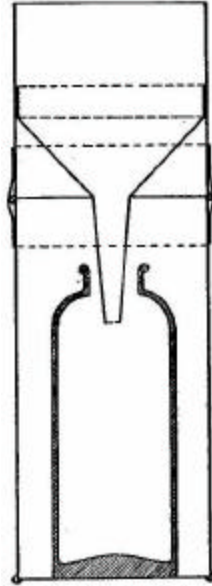

FIG. 152.—Section of home-made rain-gauge.

FIG. 152. -- Section of homemade rain-gauge.

The success of the gauge depends entirely upon ascertaining accurately how much of the tube will be filled by a column of water 1 inch deep and having the same area as the receiver. This is easily determined as follows:--If a tin is to be used as receiver, make the bottom and side joints watertight with solder; if a tube, square off one end and solder a flat metal to it temporarily. The receptacle is placed on a perfectly level base, and water is poured in until it reaches exactly to a mark made 4 inches from the

end of a fine wire held perpendicularly. Now cork one end of the tube and pour in the water, being careful not to spill any, emptying and filling again if necessary. This will give you the number of tube inches filled by the 4 inches in the receiver. Divide the result by 4, and you will have the depth unit in the measure representing 1 inch of rainfall. The measuring should be done several times over, and the average result taken as the standard. If the readings all agree, so much the better.

**Preparing the Scale.** -- The next thing is to graduate a scale, which will most conveniently be established in indelible pencil on a carefully smoothed strip of white wood 1 inch wide. First make a zero mark squarely across the strip near the bottom, and at the unit distance above it a similar mark, over which "One Inch" should be written plainly. The distance between the marks is next divided by 1/2-inch lines into tenths, and these tenths by 1/4-inch lines into hundredths, which, if the diameter of the receiver is four times that of the tube, will be about 3/16 inch apart. For reading, the scale is held against the tube, with the zero mark level with the top of the cork plugging the bottom. It will, save time and trouble if both tube and scale are attached permanently

to a board, which will also serve to protect the tube against damage.

**Making the Receiver.** -- A tin funnel, fitting the inside of the receiver closely, should be obtained, or, if the exact article is not available, a longer one should be cut down to fit. Make a central hole in the bottom of the receiver large enough to allow the funnel to pass through up to the swell, and solder the rim of the funnel to the inside of the receiver, using as little heat as possible.

If you select a tin of the self-opening kind, you must now cut away the top with a file or hack-saw, being very careful not to bend the metal, as distortion, by altering the area of the upper end of the tin, will render the gauge inaccurate.

The receiver should be supported by another tin of somewhat smaller diameter, and deep enough to contain a bottle which will hold 3 or 4 inches of rainfall. In order to prevent water entering this compartment, tie a strip of rubber (cut out of an old cycle air tube) or other material round the receiver, and projecting half an inch beyond the bottom (Fig. 152).

All tinned iron surfaces should be given a couple of thin coats or paint.

The standard distance between the rain gauge and the ground is one foot. The amount caught decreases with increase of elevation, owing to the greater effect of the wind. The top of the gauge must be *perfectly level*, so that it may offer the same catchment area to rain from whatever direction it may come.

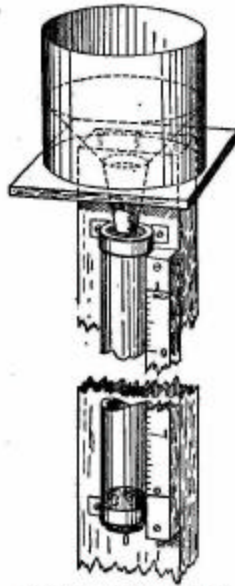

FIG. 153.—Self-measuring gauge.

FIG. 153. -- Self-measuring gauge.

**Another Arrangement.** -- To simplify measurement, the receiver and tube may be arranged as shown in Fig. 153. In this case the water is delivered directly into the measure, and the rain fall may be read at a glance. On the top of the support is a small platform for the receiver, its centre directly over the tube. The graduations, first made on a rod as already described, may be transferred, by means of a fine camel's hair brush and white paint, to the tube itself. To draw off the water after taking a reading, a hole should be *burnt* with a hot wire through the bottom cork. This hole is plugged with a piece of slightly tapered

brass rod, pushed in till its top is flush with the upper surface of the cork.

If the tube has small capacity, provision should be made for catching the overflow by inserting through the cork a small tube reaching to a convenient height—say the 1-inch mark. The bottom of the tube projects into a closed storage vessel. Note that the tube must be in position before the graduation is determined, otherwise the readings will exaggerate the rainfall.

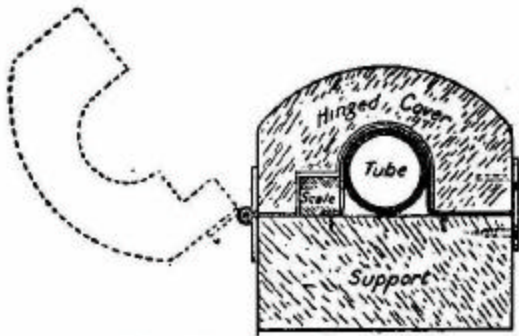

· FIG. 154.—Gauge in case.

FIG. 154. -- Gauge in case.

**Protection against the Weather.** -- A rain-gauge of this kind requires protection against frost, as the freezing of the water would burst the tube. It will be sufficient to hinge to the front of the support a piece of wood half an inch thicker than the diameter of the tube, grooved out so as to fit the tube when shut round it (Fig 154).



**XXVIII.**  
**WIND VANES WITH DIALS.**

It is difficult to tell from a distance in which direction the arrow of a wind vane points when the arrow lies obliquely to the spectator, or points directly towards or away from him. In the case of a vane set up in some position where it will be plainly visible from the house, this difficulty is overcome by making the wind vane operate an arrow moving round a vertical dial set square to the point of observation. Figs. 155 to 157 are sketches and diagrams of an apparatus which does the work very satisfactorily. The vane is attached to the upper end of a long rod, revolving freely in brackets attached to the side of a pole. The bottom end of the rod is pointed to engage with a nick in a bearer, in which it moves with but little friction. Near the end is fixed a horizontal bevel-wheel, engaging with a vertical bevel of equal size and number of teeth attached to a short rod running

through a hole in the post to an arrow on the other side. Between arrow and post is room for a dial on which the points of the compass are marked.

The construction of the apparatus is so simple as to call for little comment. The tail of the vane is made of two pieces of zinc, tapering from 8 inches wide at the rear to 4 inches at the rod, to which they are clipped by 4 screws and nuts. A stay soldered between them near the stern keeps the broader ends a couple of inches apart, giving to the vane a wedge shape which is more sensitive to the wind than a single flat plate. The pointer also is cut out of sheet metal, and is attached to the tail by means of the screws already mentioned. It must, of course, be arranged to lie in a line bisecting the angle formed by the two parts of the tail.

The rod should preferably be of brass, which does not corrode like iron. If the uppermost 18 inches or so are



FIG. 165.—Wind vane with dial.

FIG. 165 -- Wind vane with dial

of 1/4-inch diameter, and assigned a bracket some distance below the one projecting from the top of the pole, the remainder of the rod need not exceed 1/8 to 5/32 inch in diameter, as the twisting strain on it is small. Or the rod may be built up of wooden rods, well painted, alternating with brass at the points where the brackets are.

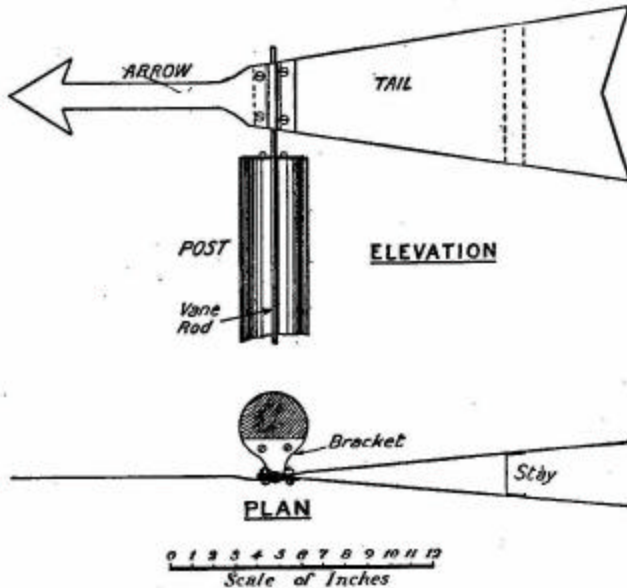

FIG. 156.—Elevation and plan of vane.

FIG. 156. -- Elevation and plan of vane.

**The Bevel Gearing.** -- Two brass bevel wheels, about 1 inch in diameter, and purchasable for a couple of

shillings or less, should be obtained to transmit the vane movements to the dial arrow. Grooved pulleys, and a belt would do the work, but not so positively, and any slipping would, of course, render the dial readings incorrect. The arrow spindle (of brass) turns in a brass tube, driven tightly into a hole of suitable size bored through the centre of the post (Fig. 157). It will be well to fix a little metal screen over the bevel gear to protect it from the weather.

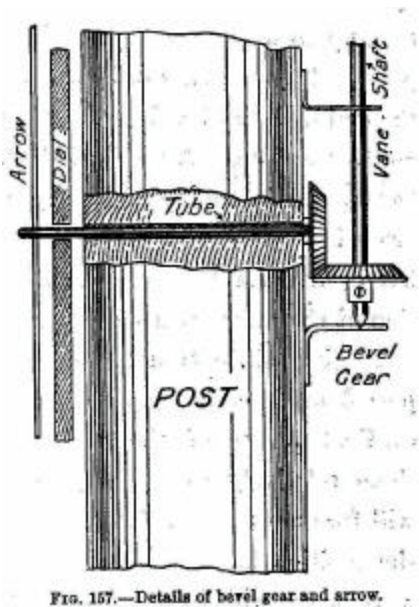

FIG. 157.—Details of bevel gear and arrow.

FIG. 157. -- Details of bevel gear and arrow.

**The Dial** -- This is made of tinned iron sheet or of 1/4-inch wood nailed to 1/2-inch battens. It is held up to the post by 3-inch screws passing through front and battens. At the points of contact, the pole is slightly flattened to give a good bearing; and, to prevent the dial being twisted off by the wind, strip

iron or stout galvanized wire stays run from one end of a batten to the other behind the post, to which they are secured.

The post should be well painted, the top protected by a zinc disc laid under the top bracket, and the bottom, up to a point 6 inches above the ground level, protected by charring or by a coat of boiled tar, before the dial and the brackets for the vane rod to turn in are fastened on. A white dial and black arrow and letters will be most satisfactory against a dark background; and *vice versa* for a light background. The letters are of relatively little importance, as the position of the arrow will be sufficient indication.

It gives little trouble to affix to the top of the pole 4 arms, each carrying the initial of one of the cardinal points of the compass. The position of these relatively to the direction in which the dial will face must be carefully thought out before setting the position in the ground. In any case the help of a compass will be needed to decide which is the north.

Having set in the post and rammed the earth tightly round it, loosen the bracket supporting the vane rod so that the vane bevel clears the dial bevel. Turn the vane to true north, set the dial arrow also

to north, and raise the bevel so that it meshes, and make the bracket tight.

*Note.* -- In the vicinity of London true north is 15 degrees east of the magnetic north.

The pole must be long enough to raise the vane clear of any objects which might act as screens, and its length will therefore depend on its position. As for the height of the dial above the ground, this must be left to individual preference or to circumstances. If conditions allow, it should be near enough to the ground to be examined easily with a lamp at night, as one of the chief advantages of the system is that the reading is independent of the visibility of the vane.

**A Dial Indoors.** -- If some prominent part of the house, such as a chimney stack, be used to support the pole--which in such a case can be quite short--it is an easy matter to connect the vane with a dial indoors, provided that the rod can be run down an outside wall.

**An Electrically Operated Dial.** -- Thanks to the electric current, it is possible to cause a wind vane, wherever it may be set, to work a dial situated anywhere indoors. A suggested method of effecting this is illustrated in Figs. 158 to 161, which are sufficiently explicit to enable the reader to fill in details for himself.

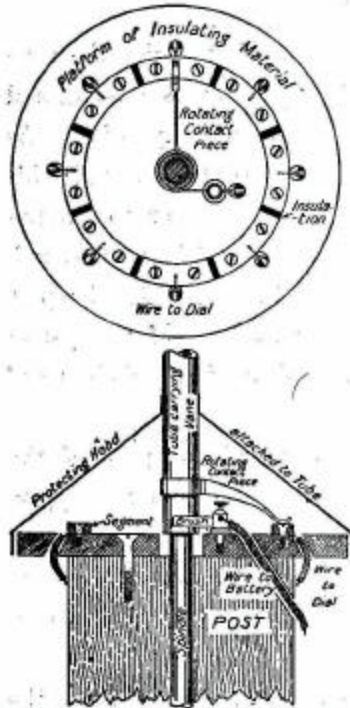

FIG. 158.—Plan and elevation of electric contact on vane post.

FIG. 158. -- Plan and elevation of electric contact on vane post.

In this case the vane is attached (Fig. 158) to a brass tube, closed at the upper end, and supported by a long spike stuck into the top of the pole. A little platform carries a brass ring, divided into as many insulated segments as the points which the vane is to be able to register. Thus, there will be eight segments if the half-points as well as the cardinal points are to be shown on the dial. The centre of each of these segments lies on a line running through the centre of the spike to the compass point to which the segment belongs. The tube moves with it a rotating contact piece, which rubs against the tops of the segments.

Below it is a "brush" of strip brass pressing against the tube. This brush is connected with a wire running to one terminal of a battery near the dial.

**The Dial.** -- This may be either vertical or horizontal, provided that the arrow is well balanced. The arrow, which should be of some light non-magnetic material, such as cardboard or wood, carries on its lower side, near the point, a piece of soft iron.

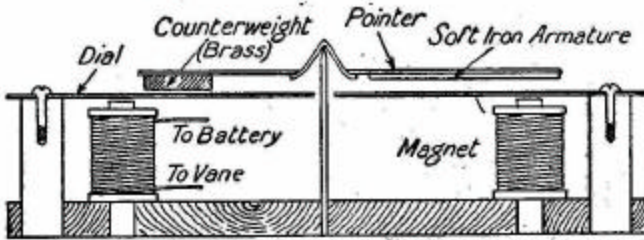

FIG. 159. -- Magnetic recording dial.

FIG. 159. -- Magnetic recording dial.

Under the path of this piece is a ring of equally spaced magnets, their number equaling that of, the segments on the vane. Between arrow and magnets is the dial on which the points are marked (Fig. 159).

Each segment is connected by a separate wire with the corresponding dial magnet, and each of these, through a common wire and switch, with the other terminal of the battery (Fig. 161).

In order to ascertain the quarter of the wind, the



switch is closed. The magnet which is energized will attract the needle to it, showing in what direction the vane is pointing. To prevent misreading, the dial may be covered by a flap the raising of which closes the battery circuit. A spring should be arranged to close the flap when the hand is removed, to prevent waste of current.

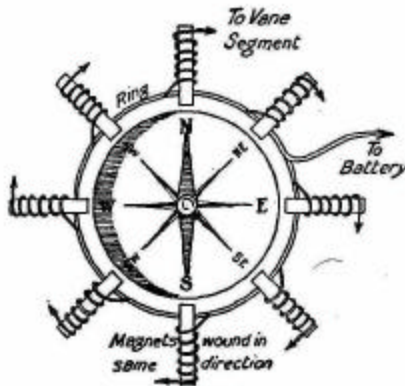

FIG. 160.—Another type of electric dial with compass needle for pointer.

FIG. 160. -- Another type of electric dial with compass needle for pointer.

The exactitude of the indication given by the arrow depends on the number of vane segments used. If these are only four, a N. reading will be given by any position of the vane between N.E. and N.W.; if eight, N. will mean anything between N.N.E. and N.N.W. Telephone cables, containing any desired number of insulated wires, each covered by a braiding of a distinctive colour, can be obtained at a cost only slightly exceeding that of an equal total amount of single insulated wire. The cable form is to be preferred, on account of its greater convenience in fixing.

The amount of battery power required depends on the length of the circuit and the delicacy of the dial. If an ordinary compass needle be used, as indicated in Fig. 160, very little current is needed. In this case the magnets, which can be made of a couple of dozen turns of fine insulated wire round a 1/8-in soft iron bar, should be arranged spokewise round the compass case, and care must be taken that all the cores are wound in the same direction, so as to have the same polarity. Otherwise some will attract the N. end of the needle and others repel it. The direction of the current flow through the circuit will decide the polarity of the magnets, so that, if one end of the needle be furnished with a little paper arrow-head, the "correspondence" between vane and dial is easily established. An advantage attaching to the use of a compass needle is that the magnet repels the wrong end of the needle.

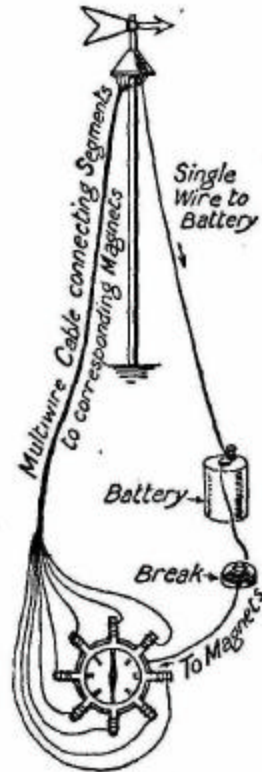

FIG. 161.—General arrangement of electric wind recorder.

FIG. 161. -- General arrangement of electric wind recorder.

The brush and segments must be protected from the weather by a cover, either attached to the segment platform or to the tube on which the vane is mounted.

The spaces between the segments must be filled in flush with some non-conducting material, such as fibre, vulcanite, or sealing-wax; and be very slightly wider than the end of the contact arm, so that two segments may not be in circuit simultaneously. In certain positions of the vane no contact will be made, but, as the vane is motionless only when there is no wind or none to speak of, this is a small matter.

**XXIX.**  
**A STRENGTH-TESTING MACHINE.**

The penny-in-the-slot strength-testing machine is popular among men and boys, presumably because many of them like to show other people what their muscles are capable of, and the opportunity of proving it on a graduated dial is therefore tempting, especially if there be a possibility of recovering the penny by an unusually good performance.

For the expenditure of quite a small number of pence, one may construct a machine which will show fairly accurately what is the value of one's grip and the twisting, power of the arms; and, even if inaccurate, will serve for competitive purposes. The apparatus is very simple in principle, consisting of but five pieces of wood, an ordinary spring balance registering up to 40 lbs., and a couple of handles.

The total cost is but a couple of shillings at the outside.

Fig. 162 is a plan of the machine as used for grip measuring. The base is a piece of deal 1 inch thick, 2 feet long, and 5-1/2 inches wide. The lever, L, is pivoted at P, attached to a spring balance at Q, and subjected to the pull of the hand at a point, R.

The pressure exerted at R is to that registered at Q as the distance PQ is to the distance PR. As the spring balance will not record beyond 40 lbs., the ratio of PQ to PR may conveniently be made 5 to 1, as this will allow for the performances of quite a strong man; but even if the ratio be lowered to 4 to 1, few readers will stretch the balance to its limit.

The balance should preferably be of the type shown in Fig. 162, having an indicator projecting at right angles to the scale through a slot, as this can be very easily fitted with a sliding index, I, in the form of a 1/4-inch strip of tin bent over at the ends to embrace the edges of the balance.

### **CONSTRUCTION.**

As the pressures on the machine are high, the construction must be solid throughout. The lever frame,

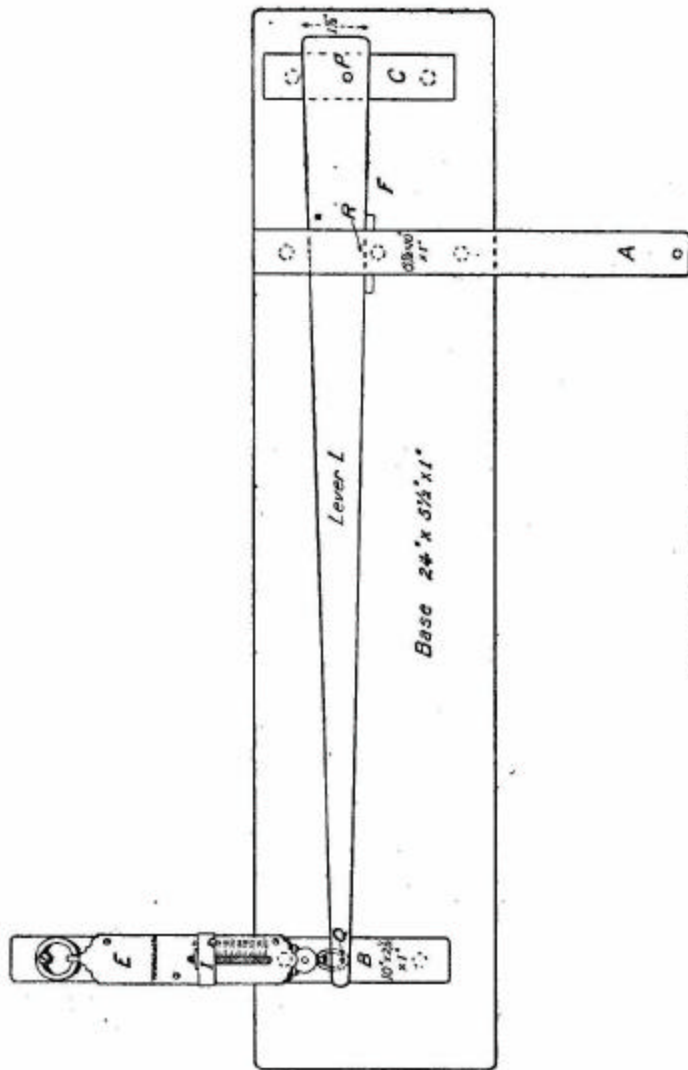

FIG. 162.--Plan of strength tester.

FIG. 162. -- Plan of strength tester.

A, and pivot piece, C, should be of one-inch oak, and the two last be screwed very securely to the baseboard. The shape of A is shown in Fig. 163. The inside is cut out with a pad saw, a square notch being formed at the back for the lever to move in. The handles of an old rubber chest expander come

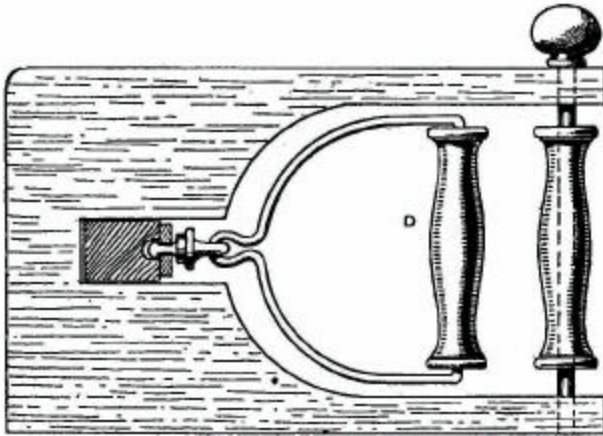

FIG. 163.—Grips of strength tester.

FIG. 163. -- Grips of strength tester.

in useful for the grips. One grip, D, is used entire for attachment to the lever; while of the other only the wooden part is required, to be mounted on a 1/4-inch steel bar running through the arms of A near the ends of the horns. If a handle of this kind is not available for D, one may substitute for it a piece of metal tubing of not less than 1/2-inch diameter, or

a 3/4-inch wooden rod, attached to an eye on the lever by a wire passing through its centre.

A handle, if used, is joined to the lever by means of a brass plate 3/4 inch wide and a couple of inches long. A hole is bored in the centre somewhat smaller than the knob to which the rubber was fastened, and joined up to one long edge by a couple of saw cuts. Two holes for good-sized screws must also be drilled and countersunk, and a socket for the knob must be scooped out of the lever. After making screw holes in the proper positions, pass the shank of the knob through the slot in the plate, and screw the plate on the lever. This method holds the handle firmly while allowing it to move freely.

The lever tapers from 1-1/2 inches at the pivot to 5/8 inch at the balance end. The hole for the pivot-- 5/16-inch steel bar--should be long enough to admit a piece of tubing fitting the bar, to diminish friction, and an important point, be drilled near the handle edge of the lever, so as to leave plenty of wood to take the strain. The last remark also applies to the hole for the balance pin at Q.

The balance support, B, and the pivot piece, C, are 2-1/2 and 2-7/16 inches high respectively. Run a hole vertically through C and the baseboard for the pivot,



which should be 4-1/2 inches long, so as to project 1 inch when driven right home. Take some trouble over getting the holes in L and C quite square to the baseboard, as any inaccuracy will make the lever twist as it moves. To prevent the pivot cutting into the wood, screw to the top of C a brass plate bored to fit the pivot accurately. The strain will then be shared by the screws.

The horns of A should be long enough to allow the outside of the fixed grip to be 2-1/4 inches from the inside of the handle.

The balance is secured first to the lever by a pin driven through the eye of the hook, and then to B by a 3-inch screw passed through the ring. The balance should just not be in tension.

When the apparatus is so far complete, test it by means of a second balance applied to D. Set the scale-marker at zero, and pull on the D balance till, say, 35 lbs. is attained. If the fixed balance shows 7 lbs. on what is meant to be a 5 to 1 ratio, the setting of R relatively to P and Q is correct. If, however, there is a serious discrepancy, it would be worth while making tests with a very strong balance, and establishing a corrected gradation on a paper dial pasted to the face of E.

For twisting tests we need a special handle (see Fig. 164), which is slipped on to the pivot and transmits the twist to L through a pin pressing on the back of the lever. The stirrup is made out of strip iron, bent to shape and drilled near the ends for the grip spindle. To the bottom is screwed and soldered a brass or iron plate, into the underside of which the pin is driven.

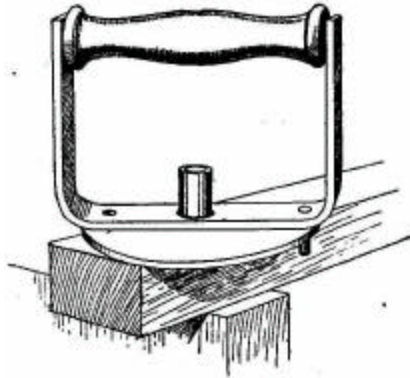

FIG. 164.—Handle for twisting test.

FIG. 164. -- Handle for twisting test.

To prevent the handle bending over, solder round the pivot hole  $\frac{3}{4}$  inch of brass tubing, fitting the pivot closely.

**Tests.** -- Grip tests should be made with each hand separately. The baseboard should lie flat on a table or other convenient support, and be steadied, but not pushed, by the hand not gripping.

Twisting tests may be made inwards with the right hand, and back-handedly with the left. The apparatus is stood on edge, square to the performer,

resting on the horns of A and a support near the balance.

Finger tests are made by placing the thumb on the front face of B, and two fingers on the farther side of the lever, one to the left and the other to the right of the tail of the balance.

**XXX.**  
**LUNG-TESTING APPARATUS.**

The capacity of the lungs, and their powers of inspiration and expiration, can be tested by means of easily constructed apparatus which will interest most people who are introduced to it. The reduction of the capabilities of the lungs to figures affords a not unprofitable form of entertainment, as even among adults these figures will be found to vary widely.

**Air Volume Measuring.** -- The air which the lungs deal with is scientifically classified under four heads:-

1. *Tidal* air, which passes into and out of the lungs in natural breathing. About 30 cubic inches in an adult (average).
2. *Reserve* air, which can be expelled after a normal expiration. About 100 cubic inches.
3. *Complemental* air, which can be drawn in after a normal inspiration. About 100 cubic inches.
4. *Residual* air, which cannot be removed from the lungs under any conditions by voluntary effort. About 120 cubic inches.

The first three added together give the *vital capacity*. This, as an addition sum will show, is very much greater than the volume of air taken in during a normal inspiration.

The simplest method of testing the capacity of an individual pair of lungs is embodied in the apparatus shown in Figs. 165 and 166. A metal box is submerged, bottom upwards, in a tank of somewhat larger dimensions, until the water is level with the bottom inside and out. A counterweight is attached to the smaller box to place it almost in equilibrium, so that if air is blown into the box it will at once begin to rise.

If we make the container  $7\frac{1}{16}$  inches square inside, in plan, every inch it rises will represent approximately 50 cubic inches of air blown in; and a height of 7 inches, by allowing for 325 cubic inches, with a minimum immersion of half an inch, should suffice even for unusually capacious lungs. The outside box need not be more than 8 inches all ways.

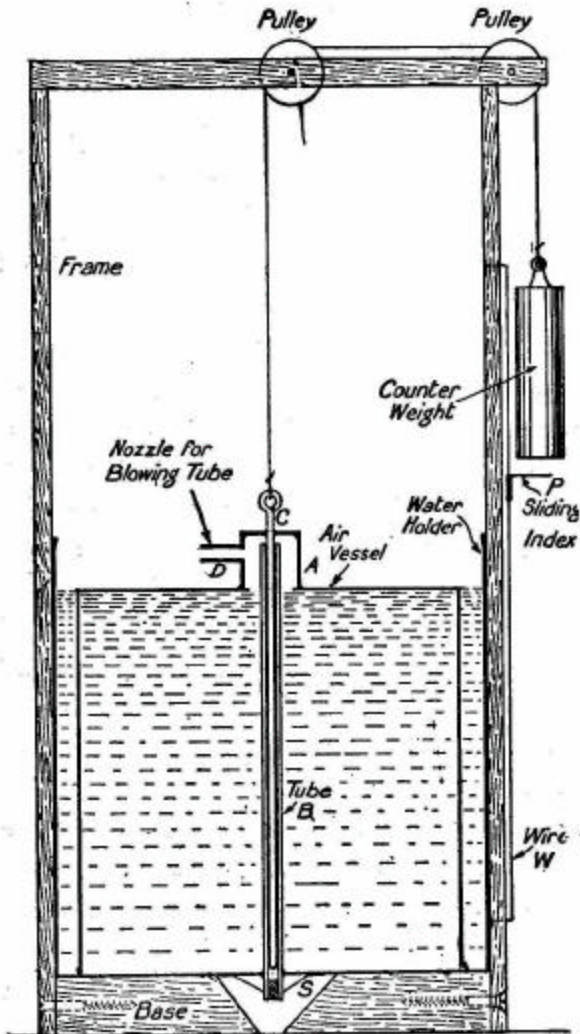

FIG. 166.—Section of lung-capacity tester.

FIG. 166. -- Section of lung-capacity tester.

Unless you are an expert with the soldering iron, the making of the boxes should be deputed to a professional tinman, who would turn out the pair for quite a small charge. Specify very thin zinc for the air vessel, and have the top edges stiffened so that they may remain straight.

On receiving the boxes, cut a hole  $\frac{3}{4}$ -inch diameter in the centre of the bottom of the air vessel, and solder round it a piece of tubing, A, 1 inch long, on the outside of the box. In the centre of the larger box make a hole large enough to take a tube, E, with an internal diameter of  $\frac{1}{8}$  inch. This tube is 8 inches long and must be quite straight. Next procure a straight wire, C, that fits the inside of the small tube easily; make an eye at the end, and cut off about 9 inches. Bore a hole for the wire in a metal disc 1 inch across.

The air container is then placed in the water box and centred by means of wooden wedges driven in lightly at the corners. Push the small tube through its hole in the water box, and thrust the wire-- after passing it through the disc and the projection on the air container--into the tube. The tube should reach

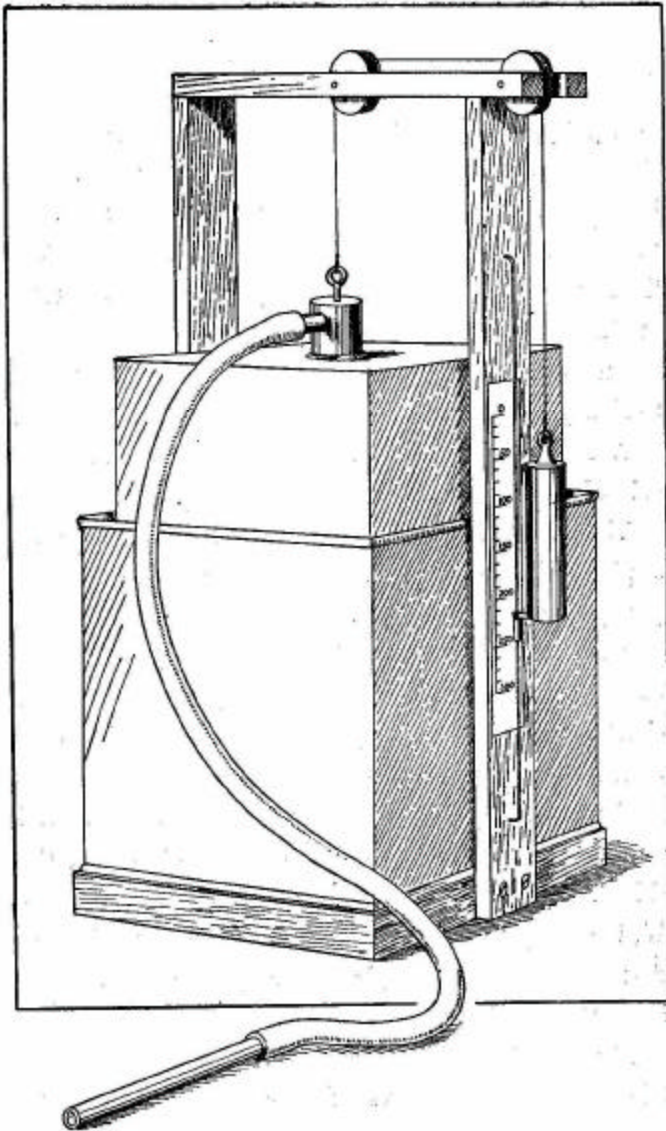

FIG. 166.—Perspective view of lung-capacity tester.

FIG. 166. -- Perspective view of lung-capacity tester.



nearly to the top of the air container, and the wire to the bottom of the water box. Solder the tube to the box, the wire to the disc, and the disc to the container. A little stay, S, will render the tube less liable to bend the bottom of the box. Plug the tube at the bottom.

The wire sliding in the tube will counteract any tendency of the container to tilt over as it rises.

A nozzle, D, for the air tube is soldered into the side of A, as shown.

The counterweight is attached to the container by a piece of fine strong twine which passes over two pulleys, mounted on a crossbar of a frame screwed to the sides of the water box, or to an independent base. The bottom of the central pulley should be eight inches above the top of the container, when that is in its lowest position.

For recording purposes, make a scale of inches and tenths, and the corresponding volumes of air, on the side of the upright next the counterweight. The wire, W, is arranged between counterweight and upright so that an easily sliding plate, P, may be pushed down it by the weight, to act as index.

*Notes.* -- The pulleys must work easily, to reduce friction, which renders the readings inaccurate.

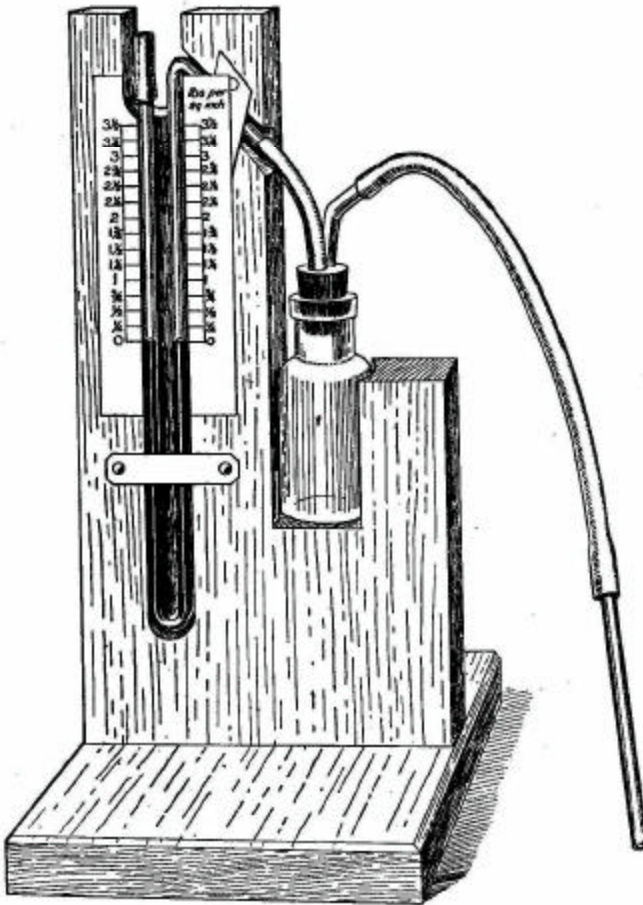

FIG. 167.—Apparatus for showing lung power.

FIG. 167. -- Apparatus for showing lung power.

Absolute accuracy is not obtainable by this apparatus, as the rising of the container lowers the water level slightly, and the air has to support part of the weight of the container which was previously borne by the water. But the inaccuracy is so small as to be practically negligible.

### **A Pressure Recorder.**

[Transcribers note: Even with the precautions used in this project, health standards of 2004 would consider any exposure to mercury dangerous. Water could be substituted and the column lengths scaled up by about 13.5.]

If mercury is poured into a vertical tube closed at the bottom, a pressure is exerted on the bottom in the proportion of approximately one pound per square inch for every two inches depth of mercury. Thus, if the column is 30 inches high the bottom pressure is slightly under 15 lbs. per square inch.

This fact is utilized in the pressure recorder shown in Fig. 167, a U-shaped glass tube half filled with mercury. A rubber tube is attached to the bent-over end of one of the legs, so that the effects of blowing or suction may be communicated to the mercury in that leg. Normally the mercury stands level in both tubes at what may be called the zero mark. Any change of level in one leg is accompanied by an equal change in the opposite direction in the other. Therefore, if by blowing the mercury is made to rise an inch in the left leg, the

pressure exerted is obviously that required to support a two-inch column of mercury--that is, 1 lb. per sq. inch. This gives a very convenient standard of measurement, as every inch rise above the zero mark indicates 1 lb. of pressure.

### **CONSTRUCTION.**

The mercury tube should be made first. Take a piece of glass tubing 20 inches long, and bend it at a point 9 inches from one end after heating in a spirit flame. The legs should be kept as parallel as possible. Lay the tube, while the heated part is still pliant, on a flat surface, the bend projecting over the edge, so that the two legs shall be in line. When the glass has cooled, bend over two inches of the longer leg to an angle of about 45 degrees.

A standard for the tube is now made out of one-inch wood. Hollow out a bed in which the tube shall lie and be completely protected. To the right of the tube the standard is notched to take a small bottle. The notch should be slightly narrower than the diameter of the bottle, and have its sides hollowed out to fit.

Halfway up the tube draw a zero mark across the standards, and above this a scale of inches in

fractions on both sides. Each inch represents 1 lb. pressure.

The cork of the bottle must be pierced with a red-hot wire for two glass tubes, one of which is bent over for the blowing tube. Both tubes should be pointed at the bottle end so that they may enter the cork easily. Make the top of the cork air tight with sealing-wax. The purpose of the bottle is to catch any mercury that might be sucked out of the tube; one does not wish mercurial poisoning to result from the experiments. Also it prevents any saliva entering the mercury tube.

When the latter has been secured to the standard by a couple of slips of tin nailed to the front, connect it up with the bottle, and fill it up to the zero mark with mercury poured in through a small paper funnel.

The open end of the tube should be provided with an inch of tubing. Clips placed on this and on the rubber connection between tube and bottle will prevent the escape of mercury should the apparatus be upset when not in use.

The average blowing pressure of which the lungs are capable is about 1-1/2 lbs. per square inch; inspiration pressure without mouth suction about 1 lb.

per square inch; suction pressure 2-1/2 to 3 lbs. per square inch.

*Caution.* -- Don't ask people with weak lungs to try experiments with the apparatus described in this chapter.

**XXXI.****HOME-MADE HARMONOGRAPHS.**

Have you ever heard of the harmonograph? If not, or if at the most you have very hazy ideas as to what it is, let me explain. It is an instrument for recording on paper, or on some other suitable surface, the figures described by two or more pendulums acting in concert.

The simplest form of harmonograph is shown in Fig. 168. Two pendulums are so suspended on points that their respective directions of movement are at right angles to one another--that is, pendulum A can swing only north and south, as it were, and pendulum B only east and west. On the top of B is a platform to carry a card, and on the upper end of A a lever is pivoted so as to be able to swing only vertically upwards and downwards. At its end this lever carries a pen, which when at rest lies on the centre of the card platform.

The bob, or weight, of a pendulum can be clamped at any point on its rod, so that the rate or "period" of swing may be adjusted or altered. The nearer

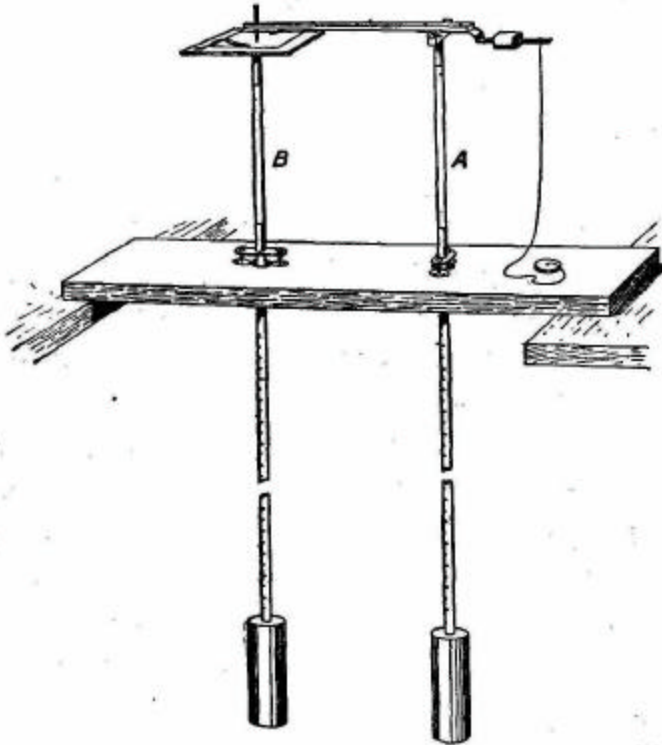

FIG. 168.—Simple Rectilinear Harmonograph.

FIG. 168. -- Simple Rectilinear Harmonograph.

the weight is brought to the point of suspension, the oftener will the pendulum swing to and fro in a given time--usually taken as one minute. From this it is obvious that the rates of swing of the two



pendulums can be adjusted relatively to one another. If they are exactly equal, they are said to be in unison, and under these conditions the instrument would trace figures varying in outline between the extremes of a straight line on the one hand and a circle on the other. A straight line would result if both pendulums were released at the same time, a circle,[1] if one were released when the other had half finished a swing, and the intermediate ellipses would be produced by various alterations of "phase," or time of the *commencement* of the swing of one pendulum relatively to the commencement of the swing of the other.

But the interest of the harmonograph centres round the fact that the periods of the pendulums can be tuned to one another. Thus, if A be set to swing twice while B swings three times, an entirely new series of figures results; and the variety is further increased by altering the respective *amplitudes* of swing and phase of the pendulums.

[Footnote 1: It should be pointed out here that the presence of friction reduces the "amplitude," or distance through which a pendulum moves, at every swing; so that a true circle cannot be produced by free swinging pendulums, but only a spiral with coils very close together.]

We have now gone far enough to be able to point out why the harmonograph is so called. In the case just mentioned the period rates of A and B are as 2: 3. Now, if the note C on the piano be struck the strings give a certain note, because they vibrate a certain number of times per second. Strike the G next above the C, and you get a note resulting from strings vibrating half as many times again per second as did the C strings--that is, the relative rates of vibration of notes C and G are the same as those of pendulums A and B--namely, as 2 is to 3. Hence the "harmony" of the pendulums when so adjusted is known as a "major fifth," the musical chord produced by striking C and G simultaneously.

In like manner if A swings four times to B's five times, you get a "major third;" if five times to B's six times, a "minor third;" and if once to B's three times, a "perfect twelfth;" if thrice to B's five times, a "major sixth;" if once to B's twice, an "octave;" and so on.

So far we have considered the figures obtained by two pendulums swinging in straight lines only. They are beautiful and of infinite variety, and one advantage attaching to this form of harmonograph is, that the same figure can be reproduced exactly an indefinite

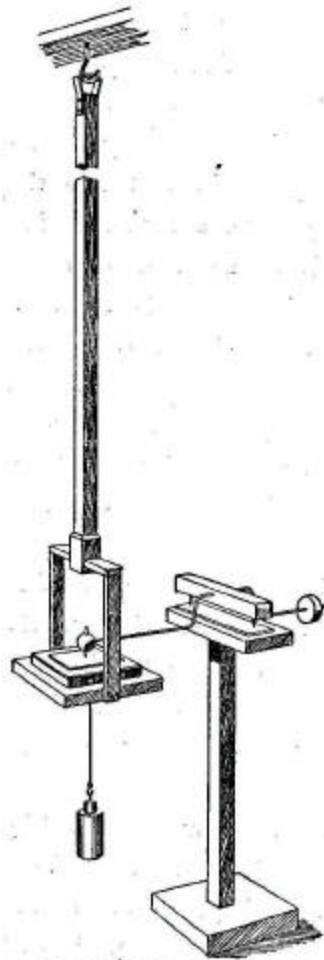

FIG. 169.—Goold's Twin Elliptic Pendulum Harmonograph.

FIG. 169. -- Goold's Twin Elliptic Pendulum Harmonograph

number of times by releasing the pendulums from the same points.

But a fresh field is opened if for the one-direction suspension of pendulum B we substitute a gimbal, or universal joint, permitting movement in *all* directions, so that the pendulum is able to describe a more or less circular path. The figures obtained by this simple modification are the results of compounded rectilinear and circular movements.

The reader will probably now see even fresh possibilities if *both* pendulums are given universal movement. This *can* be effected with the independent pendulums; but a more convenient

method of obtaining equivalent results is presented in the Twin Elliptic Pendulum invented by Mr. Joseph Goad, and shown in Fig. 169. It consists of --(1) a long pendulum, free to swing in all directions, suspended from the ceiling or some other suitable point. The card on which the figure is to be traced, and the weights, are placed on a platform at the bottom

(1,650) 24

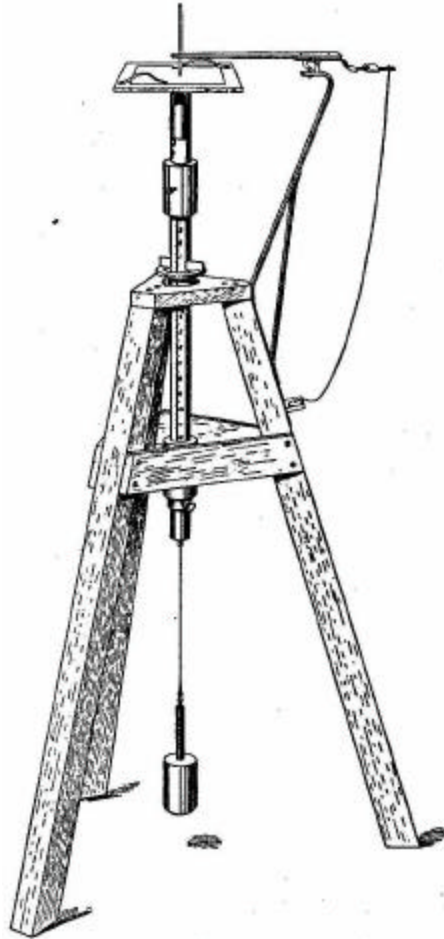

FIG. 170.—Benham's miniature Twin Elliptic Pendulum Harmonograph.

24

FIG. 170. -- Benham's miniature Twin Elliptic Pendulum Harmonograph.

of this pendulum. (2) A second and shorter free pendulum, known as the "deflector," hung from the bottom of the first.

This form of harmonograph gives figures of infinite variety and of extreme beauty and complexity. Its chief drawback is its length and weight, which render it more or less of a fixture.

Fortunately, Mr. C. E. Benham of Colchester has devised a Miniature Twin Elliptic Pendulum which possesses the advantages of the Goold, but can be transported easily and set up anywhere. This apparatus is sketched in Fig. 170. The main or platform pendulum resembles in this case that of the Rectilinear Harmonograph, the card platform being *above* the point of suspension.

**Value of the Harmonograph.** -- A small portable harmonograph will be found to be a good means of entertaining friends at home or elsewhere. The gradual growth of the figure, as the card moves to and fro under the pen, will arouse the interest of the least scientifically inclined person; in fact, the trouble is rather to persuade spectators that they have had enough than to attract their attention. The cards on which designs have been drawn are in great request, so that the pleasure of the entertainment does not

end with the mere exhibition. An album filled with picked designs, showing different harmonies and executed in inks of various colours, is a formidable rival to the choicest results of the amateur photographer's skill.

### **Practical Instructions for making Harmonographs.**

**Pendulums.** -- For the Rectilinear type of harmonograph wooden rods  $\frac{5}{8}$  to  $\frac{3}{4}$  inch in diameter will be found very suitable. They cost about 2d. each. Be careful to select straight specimens. The upper pendulum of the Miniature Twin Elliptic type should be of stouter stuff, say a broomstick; that of the Gould apparatus stouter still.

All pendulums on which weights are slid up and down should be graduated in inches and fractions, reckoning from the point of suspension as zero. The graduation makes it easy to re-establish any harmony after the weights have been shifted.

**Suspensions.** -- For a harmonograph to give satisfaction it is necessary that very little friction should be set up at the point of suspension, so that the pendulums may lose amplitude of swing very slowly.

One-way suspensions are easily made. Two types, the point and knife-edge respectively, are shown in

Fig. 168 and the top part of Fig. 172. The point suspension is most suitable for small rods and moderate weights; the knife-edge for large rods and heavy weights which would tend to crush a fine point.

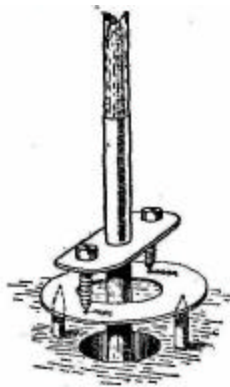

FIG. 171.—Gimbal giving universal movement: point suspension.

FIG. 171. -- Gimbal giving universal movement: point suspension.

Points should rest in cup-shaped depressions in a metal plate; knife-edges in V-shaped grooves in a metal ring.

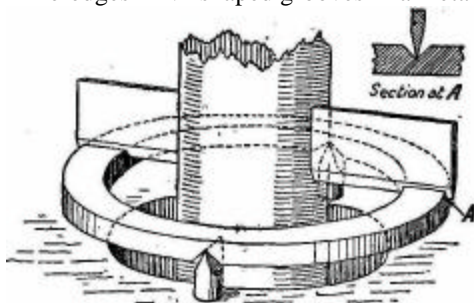

FIG. 172.—Knife-edge universal-motion gimbal.

FIG. 172. -- Knife-edge universal-motion gimbal.

Screws turned or filed to a sharp end make convenient points, as they can be quickly adjusted so that a line joining the points lies exactly at right angles to the pendulum. The cups to take the points should not be drilled until the points have been thus adjusted. Make a punch mark on the bedplate, and using this as centre for one of the points, describe an arc of a circle with the other. This will give the exact centre for the other cup. It is evident that if points and cup centres do not coincide exactly there must be a certain amount of jamming and consequent friction.

In making a knife-edge, such as that shown in Fig. 172, put the finishing touches on with a flat file drawn lengthwise to ensure the edge being rectilinear. For the same reason the V slots in the ring support should be worked out together. If they are formed separately, the chances are against their being in line with one another.

**Gimbals**, or universal joints, giving motion in all directions, require the employment of a ring which supports one pair of edges or points (Fig. 172), and is itself supported on another pair of edges or points set at right angles to the first. The cups or nicks in the ring should come halfway through, so that all four points of suspension shall be in the same plane. If they are not, the pendulum will not have the same swing-period in all directions. If a gimbal does not work with equal freedom in all ways, there will be a tendency for the pendulum to lose motion in the direction in which most friction occurs.

By wedging up the ring of a gimbal the motion of



the pendulum is changed from universal to rectilinear. If you are making a harmonograph of the type shown in Fig. 168, use a gimbal for the platform pendulum, and design it so that the upper suspension gives a motion at right angles to the pen pendulum. The use of two little wedges will then convert the apparatus in a moment from semirectilinear to purely rectilinear.

**Weights.** -- The provision of weights which can be slipped up and down a rod may present some difficulty. Of iron and lead, lead is the more convenient material, as occupying less space, weight for weight, and being more easily cast or shaped. I have found thin sheet roofing lead, running 2 lbs. to the square foot, very suitable for making weights, by rolling a carefully squared strip of the material round the rod on which it will have to move, or round a piece of brass tubing which fits the rod. When the weight has been rolled, drill four holes in it, on opposite sides near the ends, to take nails, shortened so that they just penetrate all the laps but do not enter the central circular space. These will prevent the laps sliding over one another endways. A few turns of wire round the weight over the heads makes everything snug.

Just one caution here. The outside lap of lead

should finish at the point on the circumference where the first lap began, for the weight to be approximately symmetrical about the centre.

An alternative method is to melt up scrap lead and cast weights in tins or flowerpots sunk in sand, using an accurately centred stick as the core. This stick should be very slightly larger than the pendulum rod, to allow for the charring away of the outside by the molten metal. (*Caution.*--The mould must be quite dry.)

Failing lead, tin canisters filled with metal scrap may be made to serve. It will in this case be necessary to bore the lid and bottom centrally and solder in a tube fitting the rod, and to make an opening through which the weighting material can be inserted.

**Adjustment of Weights.** -- As lead is too soft a metal to give a satisfactory purchase to a screw--a thread cut in it soon wears out--it is better to support a leaden weight from underneath by means of a brass collar and screw. A collar is easily made out of a bit of tubing thickened at the point where the screw will pass by soldering on a suitably shaped piece of metal. Drill through the reinforcement and tubing and tap to suit the screw used, which may well be a camera tail screw, with a large flat head.

I experienced some trouble from the crushing of wooden rods by a screw, but got over it as follows. The tubing selected for the collar was large enough to allow a piece of slightly smaller tubing to be introduced between it and the rod. This inner piece was slit from one end almost to the other, on opposite sides, and soldered at one end to the outer tube, a line joining the slots being at right angles to the axis of the screw. The pressure of the screw point was thus distributed over a sufficient area of the wood to prevent indentation. (See Fig. 173.)

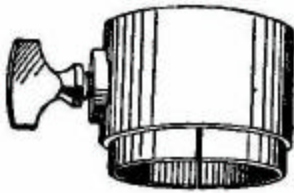

FIG. 173.

FIG. 173.



FIG. 174.—Pivot for pen lever.

FIG. 174. -- Pivot for pen lever.

**Pen Levers.** -- The pen lever, of whatever kind it be, must work on its pivots with very little friction, and be capable of fine adjustment as regards balance. For the Rectilinear Harmonograph the form of lever pivot shown in Fig. 174 is very suitable. The spindle is a wire nail or piece of knitting needle sharpened at both ends; the bearings, two screws filed flat at the ends and notched with a drill.

The brass standard should be drilled and tapped to fit the screws fairly tight, so that when once adjusted they may not slacken off. If the lever is made of wood, the tail may be provided with a number of metal pegs on which to place the weights; if of wire, the tail should be threaded so that a brass weight and lock screw may be moved along it to any desired position. It is very important that the pressure of the pen on the card should be reduced to a minimum by proper balancing, as the friction generated by a "heavy" pen slows the pendulum very quickly; and that the centre of gravity should be below the point of suspension, to put the pen in stable equilibrium. The lever shown in Fig. 169 is suitable for the Twin Elliptic Pendulum.

In this case the lever is not moved about as a whole. Mr. C. E. Benham advocates the use of wood covered with velvet to rest the lever points on.

For keeping the pen, when not in use, off the platform, a small weight attached to the lever by a thread is convenient. When the pen is working, the weight is raised to slacken the thread.

**Attaching Pen to Lever.** -- In the case of wooden levers, it is sufficient to slit the end centrally for a few inches after drilling a hole rather smaller than

the pen, at a point which lies over the centre of the card platform, and quite squarely to the lever in all



FIG. 175.—End of pen lever.

FIG. 175. -- End of pen lever.

directions, so that the pen point may rest squarely on the card. (Fig. 175.)

Another method is to attach to the end of the lever a vertical half-tube of tin, against which the pen is pressed by small rubber bands; but even more convenient is a small spring clip shaped as in Fig. 176.



FIG. 176.—Clip to hold glass pen.

FIG. 176. -- Clip to hold glass pen.

The card platform should be perfectly flat. This is essential for the production of good diagrams. If wood is used, it is advisable to glue two thin pieces together under pressure, with the grain of one running at right angles to the other, to prevent warping.

Another important point is to have the card platform square to the rod. If a piece of tubing fitting the rod is turned up true in the lathe and soldered to a disc screwed to the underside of the table, perpendicularity will be assured, and incidentally the table is rendered detachable.

To hold the card in place on the table, slit a spring of an old photographic printing frame down the middle, and screw the two halves, convex side upwards, by one end near two opposite corners of the platform. (See Fig. 170.) If cards of the same size are always used, the table should be marked to assist adjustment.

**Making Pens.** -- The most satisfactory form of pen is undoubtedly a piece of glass tubing drawn out to a point, which is ground down quite smooth. The making of such pens is rather a tedious business, but if care be taken of the pen when made it will last an indefinite time.

Tubing  $\frac{3}{16}$  or  $\frac{1}{8}$  inch in external diameter is suitable. Break it up (by nicking with a file) into 9-inch lengths. Take a piece and hold its centre in the flame of a small spirit lamp, and revolve it till it softens. Then draw the glass out in as straight a line as possible, so that the points may be central. If the drawing is done too fast, the points will be much too long to be of any use: half an inch of taper is quite enough.

Assuming that a point of satisfactory shape has been attained--and one must expect some failures before this happens--the pen may be placed in the pen lever and ground down on a *perfectly clean* wet hone laid on the card platform, which should be given a circular movement. Weight the lever so as to put a fair pressure on the point.

The point should be examined from time to time under a strong magnifying-glass, and tested by blowing through it into a glass of water. For very liquid ink the hole should be as small as you can possibly get it; thick inks, such as Indian, require coarser pens.

The sharp edge is taken off and the width of the point reduced by drawing the pen at an angle along the stone, revolving it all the time. The nearer to the hole you can wear the glass away the finer will be the line made by the pen.

Another method is as follows:--Seal the point by holding it a moment in the flame. A tiny bulb forms on the end, and this has to be ground away till the central hole is reached. This is ascertained by the water test, or by holding the pen point upwards, so that light is reflected from the tip, and examining it under the magnifier. Then grind the edge off, as in the first case.

**Care of Pens.** -- The ink should be well strained, to remove the smallest particles of "suspended matter," and be kept corked. *Fill* the pen by suction. On no account allow the ink to dry in the pen. Squirt any ink out of it when it is done with, and place it point downwards in a vessel of water, which should have a soft rubber pad at the bottom, and be kept covered to exclude dust. Or the pen may be cleaned out with water and slipped into a holder made by rolling up a piece of corrugated packing-paper. If the point gets stopped up, stand the pen in nitric or sulphuric acid, which will probably dissolve the obstruction; and afterwards wash it out.

**Inks.** -- I have found Stephens's coloured inks very satisfactory, and can recommend them.

**Paper and Cards.** -- The paper or cards used to draw the figures on should not have a coated surface, as the coating tends to clog the pen. The cheapest suitable material is *hot pressed* paper, a few penny-worths of which will suffice for many designs. Plain white cards with a good surface can be bought for from 8s. to 10s. per thousand.

**Lantern Slides.** -- Moisten one side of a clean lantern slide plate with paraffin and hold it over a candle flame till it is a dead black all over. Very fine



tracings can be obtained on the smoked surface if a fine steel point is substituted for the glass pen. The design should be protected by a cover-glass attached to it by a binding strip round the edges.

### **Details of Harmonographs.**

The reader may be interested in details of the apparatus shown in Figs. 168 and 170, made by the writer.

The Rectilinear Harmonograph, shown in Fig. 168, has pendulums of 5/8-inch wood, 40 inches long, suspended 30 inches from the lower ends, and set 10 inches apart, centre to centre. The suspensions are of the point type. The weights scale 5 lbs. each. The platform pendulum is provided with a second weight, which can be affixed above the suspension to slow that pendulum for 2:3, 4:5, 7:8, and higher harmonies.

The baseboard is plain, and when the apparatus is in action its ends are supported on boxes or books laid on two tables, or on other convenient supports. The whole apparatus can be taken to pieces very quickly for transport. The total cost of materials used did not exceed 3s. 6d.

The Twin Elliptic Pendulum of Fig. 170 is supported

on a tripod base made of three pieces of 1-1/2 x 1-1/2 inch wood, 40 inches long, with ends cut off to an angle of 72 degrees to give a convenient straddle, screwed at the top to an oak head 3/4 inch thick, and braced a foot below the top by horizontal crossbars 2 inches wide and 1/2 inch thick. For transport this stand can be replaced by a flat baseboard similar to that of the Rectilinear Harmonograph described in the last paragraph.

The main pendulum is a straight ash rod, 33 inches long and 1-1/4 inches in diameter, suspended 13-1/2 inches from its upper end. Two weights of 4-1/2 lbs. each, made of rolled sheet lead, are provided for this pendulum. According to the nature of the harmony, one only, or both together below the suspension, or one above and one below, are used.

The weight of the lower pendulum, or deflector, is supported on a disc, resting on a pin passing through the bottom of a piece of brass tubing, which is provided with an eye at its upper end. This eye is connected by a hook with several strands of silk thread, which are attached to the upper pendulum by part of a cycle tyre valve. The stem part of the valve was cut off from the nut, and driven into a suitably sized hole in the end of the main pendulum.

The screw collar for holding the valve in place had a little brass disc soldered to the outside, and this disc was bored centrally for the threads to pass through. The edges of the hole had been rounded off carefully to prevent fraying of the threads. (Fig. 177.) The over-all length of the pendulum, reckoning from the point of suspension, is 20 inches. The weights of the lower pendulum are several in number, ranging from 1 lb. to 3 lbs.

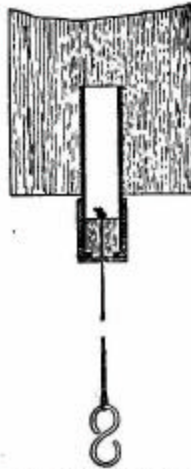

FIG. 177.—Suspension for lower weight of Twin Elliptic Harmonograph.

FIG. 177. -- Suspension for lower weight of Twin Elliptic Harmonograph.

**Working the Harmonograph.** -- A preliminary remark is needed here. Harmonies are, as we have seen, a question of ratio of swing periods. The larger the number of swings made by the more quickly moving pendulum relatively to that of the slower pendulum in a given time, the higher or sharper is the harmony said to be. Thus, 1:3 is a higher harmony than 1:2, and 2:3 is lower or flatter than 3:8.

The tuning of a harmonograph with independent pendulums is a simple matter. It is merely necessary to move weights up or down until the respective numbers of swings per minute bear to one another

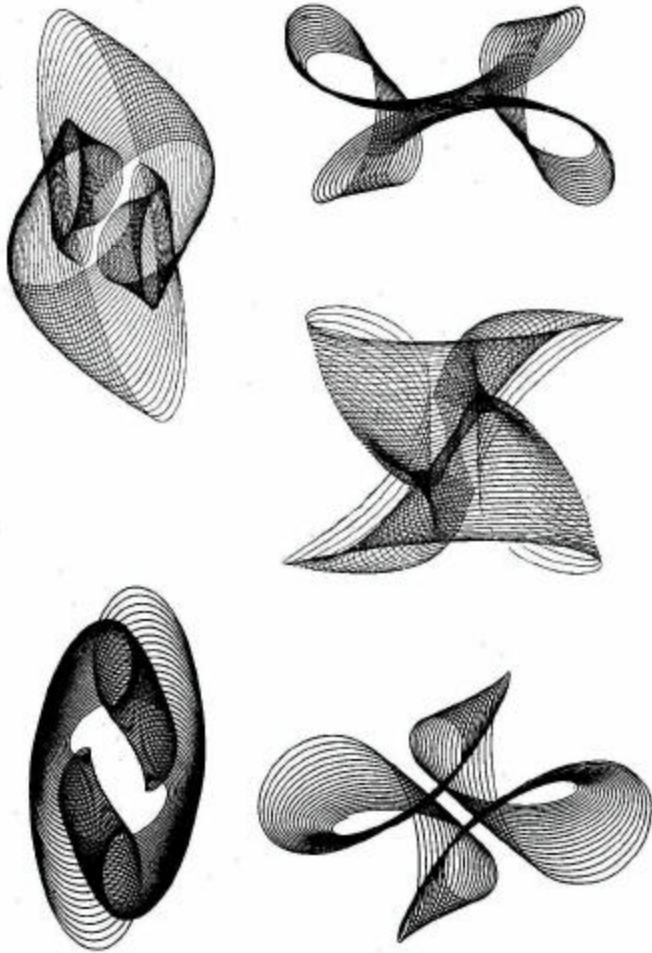

FIG. 176a.—Hamonograms illustrating the ratio 1 : 3. The two on the left are made by the pendulums of a twin elliptical harmonograph when working concurrently; the three on the right by the pendulums when working antagonistically.

FIG. 176a. -- Hamonograms illustrating the ratio 1:3. The two on the left are made by the pendulums of a twin elliptical harmonograph when working concurrently; the three on the right by the pendulums when working antagonistically.

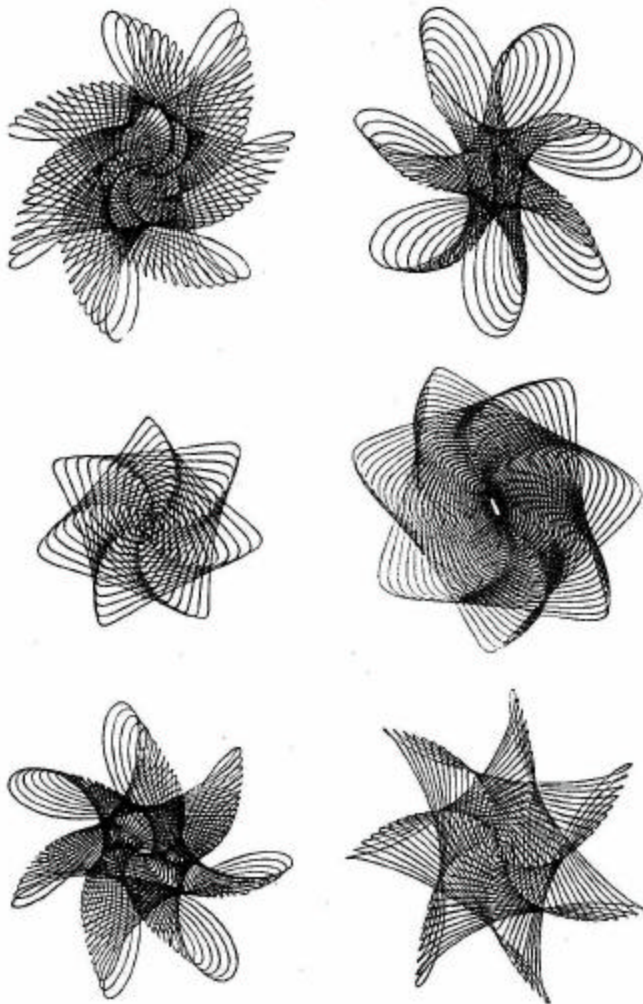

FIG. 177a. -- Harmonograms of 3 : 4 ratio (antagonistic).  
(Reproduced by kind permission of Mr. C. E. Benham.)

FIG. 177a. -- Harmonograms of 3:4 ratio (antagonistically).  
(Reproduced with kind permission of Mr. C. E. Benham.)

the ratio required. This type of harmonograph, if made of convenient size, has its limitations, as it is difficult to get as high a harmonic as 1:2, or the octave with it, owing to the fact that one pendulum must in this case be very much shorter than the other, and therefore is very sensitive to the effects of friction.

The action of the Twin Elliptic Pendulum is more complicated than that of the Rectilinear, as the harmony ratio is not between the swings of deflector and upper pendulum, but rather between the swings of the deflector and that of the system as a whole.

Consequently "tuning" is a matter, not of timing, but of experiment.

Assuming that the length of the deflector is kept constant--and in practice this is found to be convenient--the ratios can be altered by altering the weights of one or both pendulums and by adjustment of the upper weight.

For the upper harmonies, 1:4 down to 3:8, the two pendulums may be almost equally weighted, the top one somewhat more heavily than the other. The upper weight is brought down the rod as the ratio is lowered.

To continue the harmonies beyond, say, 2:5, it is

necessary to load the upper pendulum more heavily, and to lighten the lower one so that the proportionate weights are 5 or 6:1. Starting again with the upper weight high on the rod, several more harmonies may be established, perhaps down to 4:7. Then a third alteration of the weights is needed, the lower being reduced to about one-twentieth of the upper, and the upper weight is once more gradually brought down the rod.

Exact figures are not given, as much depends on the proportions of the apparatus, and the experimenter must find out for himself the exact position of the main weight which gives any desired harmonic.

A few general remarks on the action and working of the Twin Elliptic will, however, be useful.

1. Every ratio has two forms.

(a) If the pendulums are working *against* each other--antagonistically--there will be loops or points on the *outside* of the figure equal in number to the *sum* of the figures in the ratio.

(b) If the pendulums are working *with* each other--concurrently--the loops form *inside* the figure, and are equal in number to the *difference* between the figures of the ratio.

To take the 1:3 ratio as an example. If the tracing has  $3+1=4$  loops on the outside, it is a

specimen of antagonistic rotation. If, on the other hand, there are  $3-1=2$  loops on the inside, it is a case of concurrent rotation. (Fig. 176, A.)

2. Figures with a ratio of which the sum of the numbers composing it is an *even* number (examples, 1:3, 3:5, 3:7) are symmetrical, one half of the figure reproducing the other. If the sum is Uneven, as in 1:2, 2:3, 2:7, the figure is unsymmetrical. (Fig. 177, A.)

3. The ratio 1:3 is the easiest to begin upon, so the experimenter's first efforts may be directed to it. He should watch the growth of the figure closely, and note whether the repeat line is made *in front* of or *behind* the previous line of the same loop. In the first case the figure is too flat, and the weight of the upper pendulum must be raised; in the second case the weight must be lowered. Immediately an exact harmonic is found, the position of the weight should be recorded.

Interesting effects are obtained by removing the lower pendulum and allowing the apparatus to describe two elliptical figures successively, one on the top of the other, on the same card. The crossing of the lines gives a "watered silk" appearance to the design, which, if the pen is a very fine one and



the lines very close together, is in many cases very beautiful.

Readers who wish for further information on this fascinating subject are recommended to purchase "Harmonic Vibrations," published by Messrs. Newton and Co., 72 Wigmore Street, London, W. This book, to which I am much indebted, contains, besides much practical instruction, a number of charming reproductions of harmonograms.

Before closing this chapter I should like to acknowledge the kind assistance given me by Mr. C. E. Benham, who has made a long and careful study of the harmonograph.

**XXXII.**  
**A SELF-SUPPLYING MATCHBOX.**

This useful little article can be constructed in a couple of hours by a handy person. In general idea it consists of a diamond-shaped box to hold vestas, working up and down diagonally on a vertical member (A in Fig. 179 (1)), which passes through slits at the top and bottom, and runs in grooves cut in the sides of the box. The top of A is grooved to allow a match to rest on it. When the box is drawn up to the full extent allowed by a transverse pin in the slot shown in Fig. 179 (2), the groove is at the lowest point of the box, and is covered by the matches. When the box is lowered, A catches a vesta and takes it up through the top, as seen in Fig. 178, for removal by the fingers.

The only materials required are a cigar-box, some pins, and a supply of glue. The box should be carefully taken to pieces, and the parts soaked in hot

water till freed of all paper, and then allowed to dry under pressure, small slips of wood being interposed across the grain to keep them separate and permit the passage of air.

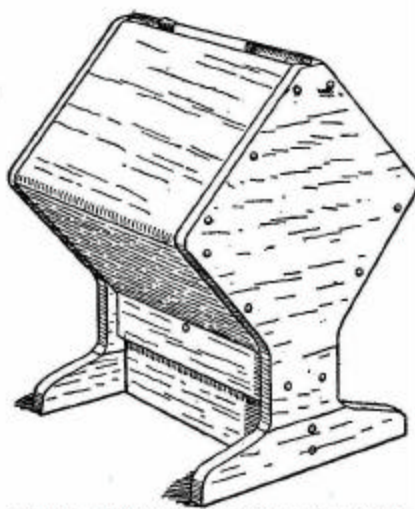

FIG. 178.—Self-supplying matchbox, with match in position for removal by fingers.

FIG. 178. -- Self-supplying matchbox, with match in position for removal by fingers.

When the wood is dry, cut out with a fret saw two pieces shaped like Fig. 179 (3), to form the ends of the box. Allow a little surplus, so that the edges may be finished off neatly with chisel and plane. The two ends should match exactly, or there will be trouble at a later stage.

Now cut, down the centre of each a groove for one edge of A to run in. By preference it should be square; but if you do not possess the necessary chisel, a V groove made with a knife will suffice--and, of course, in this case the edges of A will have to be bevelled to fit.

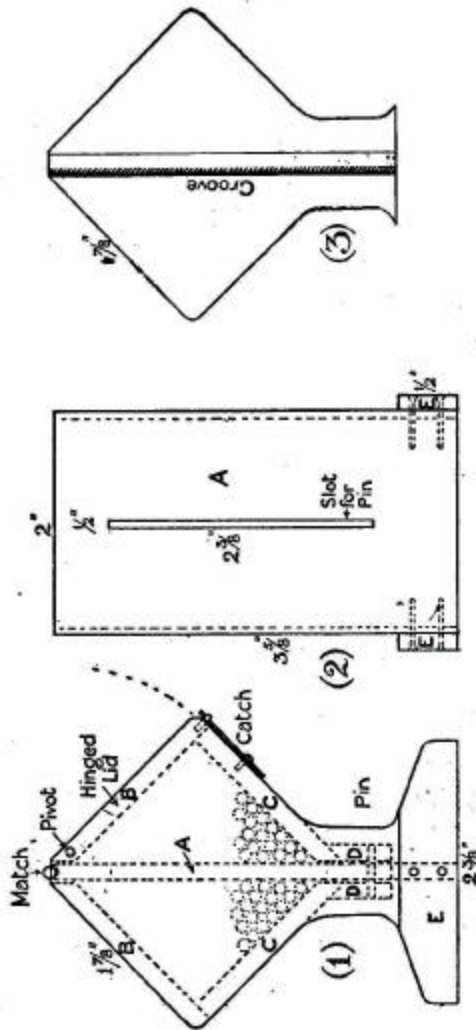

FIG. 179.—Details of self-supplying matchbox

FIG. 179. -- Details of self supplying matchbox

The four sides of the box, BB and CC, are next cut out. Their sectional shape is shown in Fig. 179 (1). They should be rather longer than the length of the ordinary vesta, and all of exactly the same length, and rectangular. A very small hack saw (costing about 1s.) with fine teeth is the best possible tool for close cutting, and a small 1s. iron plane is invaluable for truing and bevelling the edges.

The glue pot, which we will assume to be ready for use, is now needed to attach the fixed B (the other B is hinged to form a lid for filling the box through) and CC to the ends. This operation must be carried out accurately, so that the slots may not be blocked.

While the glue is setting, cut out A, allowing an extra  $1/16$  inch of width for fitting. The slot down the centre is best made with a fret saw, and should be smoothed internally by drawing a strip of fine glass paper to and fro through it. The length of the slot is of great importance. It must reach to just that distance from the top edge which brings that edge flush with the bottom of the box when the box is raised; and in the other direction must permit the box to settle on to its foot, so that the match lifted shall project above the box.

Work the edges of A down carefully (double-bevelling them if the notches are V-shaped) till A will run easily, but not loosely, in the box. Then cut out two slips, DD, and bevel them at the top to an angle of 45 degrees. Put A in place and glue them on, taking care that the glue does not hold them fast to A.

Pierce a small hole through DD, in line with the slot, and insert a pin. Draw the box fully up, and see if the top of A sinks to the proper place. If it projects a little, lengthen the slot a trifle.

Cut out the supports EE, finish them neatly, and glue them to A. Make sure that the pin lets the box touch them.

Fix on the lid B with two pins for pivots, and fit a little catch made of brass wire. To give extra security, drive ordinary pins, cut off to 5/8 inch, through the sides into fixed B, CC, and DD, and through EE into A. This is an easy enough business if pilot holes are made with a very fine awl or a tiny drill, and a small, light hammer is used. It now remains only to go over the whole box with glass paper or emery cloth, and to glue a diamond of coarse glass paper to one end for striking the matches on.

*Note* that the lid must not be opened when the box is down, as it would be wrenched off its pivots.

**XXXIII.**  
**A WOODEN WORKBOX.**

The box illustrated by Fig. 181 was copied from an article of Norwegian manufacture. Its construction is an extremely simple matter, provided that one can get a piece of easily bent wood (birch, for instance), not exceeding  $\frac{3}{16}$  inch in thickness, for the sides.

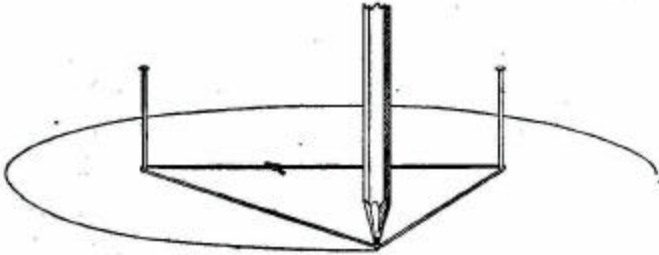

FIG. 180.—Showing how to draw an ellipse.

FIG. 180. -- Showing how to draw an ellipse.

The bottom of the box is made of  $\frac{5}{16}$  or  $\frac{3}{8}$  inch wood, cut to an oval or elliptical shape. To mark out an ellipse about 8 inches long and  $5\frac{1}{2}$  inches wide--this will be a convenient size--stick two pins into

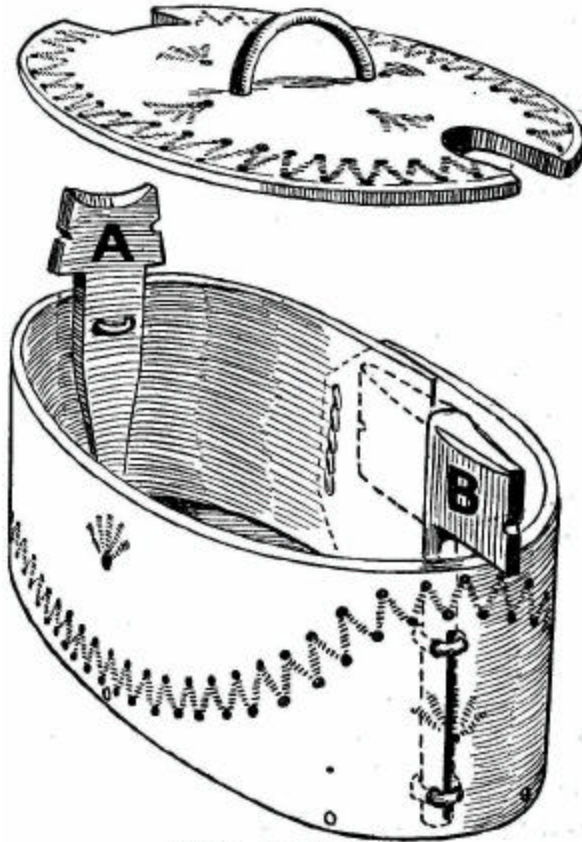

FIG. 181.—Norwegian workbox.

FIG. 181. -- Norwegian workbox.

the board  $5\frac{1}{8}$  inches apart, pass a loop of thread 14 inches in circumference round these, and run the point of a pencil round the pins in the path which it has



to take when confined by the slack of the loop (Fig. 180). Fret-saw along the line.

The wood strip for the side is 4-1/2 inches deep, and 1-1/2 inches longer than the circumference of the bottom. The ends are thinned off somewhat, as shown in Fig. 181, to prevent the lap having a clumsy appearance, and the surface is smoothed all over with sandpaper. Bore a number of small nail holes 3/16 inch from one edge, and then steam the wood over a big saucepan or other suitable vessel until it is quite lissom.

When attaching the side piece to the bottom, begin at the middle, and work first towards what will be the inside end of the lap, and then towards the outside end. Nails are driven in through the holes already drilled. When nailing is finished, clip the top of the overlap with a hand-vice or screw spanner, to prevent the tops of the ends sliding over one another, and bore a line of holes 1/4 inch apart, and at the same distance from the outer end. Fine copper wire drawn to and fro through alternate holes from one end of the row to the other and back again, will secure the joint.

The lid overlaps the side 1/4 inch in all directions and has a square notch cut in it at one end to pass

under the piece A, and at the other a deeper, circular-ended nick to enable it to pass over the key B when that is turned into the position shown in the illustration. A is cut out of 1/4-inch wood; B, in one piece, out of 1/2-inch. Their length under the heads exceeds the inside depth of the box by the thickness of the lid.

A is affixed rigidly to the side by small screws or wire, while B must be attached in a manner, which will allow the head to rotate. Cut two nicks round the shank, and two horizontal slots at the same height through the end of the box. A couple of brass rings must then be procured of such a size that, when flattened into a somewhat oval shape, they will project beyond the slots sufficiently to allow a piece of wire to pass through them and prevent their being drawn back again.

Quarter-inch wood will do for the lid. A handle is made out of a couple of inches of small cane bent into a semicircle, let through the lid at each end, glued, and cut off flush.

The exterior may be decorated by a design in poker-work, or be stained and varnished. This is left to the maker's discretion.

**XXXIV.**  
**WRESTLING PUPPETS.**



FIG. 182.— Peg  
marked for cut-  
ting and drilling.

FIG. 182. -- Peg marked for cutting and drilling.

The expenditure of a halfpenny, and a quarter of an hour's use of a pocket knife, bradawl, and pliers, will produce a toy which is warranted to amuse grown-ups as well as children. Wrestlers made out of clothes pegs may be bought for a copper or two in the street, and are hardly a novelty; yet a few notes on home production will not be a waste of space, as making is cheaper, and much more interesting, than buying.

The clothes pegs used must be of the shape shown in Fig. 182, with a round top. They cost one penny per dozen.

Drill holes through body and legs as indicated in Fig. 182. Cut the legs from the "trunk," and whittle them to the shape of Fig. 183. The arms, made out of any

thin wood, are 2-1/4 inches long between centres of end holes.

To get the best results the two arms and the four legs should be paired off to exactly the same length.

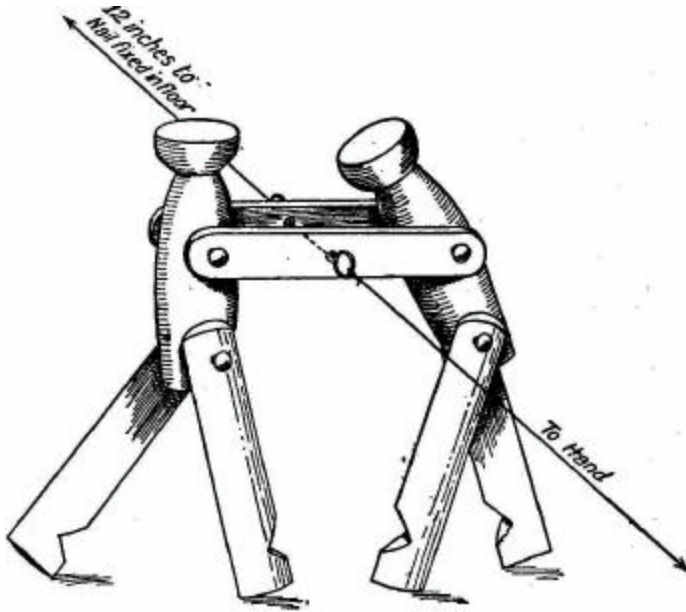

FIG. 183. -- Clothes-peg wrestlers.

The neatest method of attaching the parts is to use small brass tacks, which must, of course, be of some what larger diameter than the holes in the body. Holes in arms and legs are a loose fit, so that the wrestlers may be very loose-jointed, and the tacks must not be driven in far enough to cause any friction.

Instead of tacks one may use wire passed through the parts and secured by a bend or loop at each end. Wire has the disadvantage of entangling the thread which works the figures.

When assembling is finished, bore holes in the centres of the arm pieces, pass a piece of wire through, and twist it into a neat loop at each end. To one loop tie 2 feet of strong thread (carpet thread is best), and to the free end of the thread a large nail or hook. The other loop has 6 feet or so of thread tied to it, to be worked by the hand. If the thread is stained black, it will be practically invisible by artificial light.

The nail or hook is stuck under the edge of the carpet, or into some crack or cranny which affords a good hold, and the wrestlers are worked by motions of the hand. The funniest antics are produced by very slight jerks.

If the arms are set too close together the heads may stick between them, in which case one must either flatten off the sides of the heads or insert fresh arm wires of greater length. If a head persists in jamming against the thread wire or getting under it

and staying there, cut 1/2 inch off a pin and stick it into the front of the crown, so that the head is arrested by the wire when the wrestler bends forward.

**Large Wrestlers.** -- A more elaborate and realistic pair is shown in Fig. 184. The originals of the sketch are 8 inches high. Half-inch deal was used for the

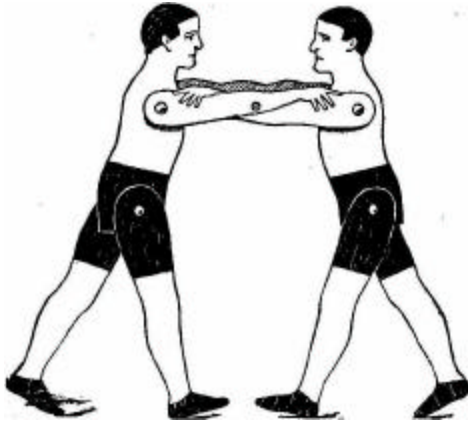

FIG. 184. -- Large wrestlers made of stout wood.

bodies, 3/8-inch for the legs and arms. The painting-in of hair, features, tights, and shoes adds considerably to the effect. The heads and limbs are mere profiles, but anyone with a turn for carving might spend a little time in rounding off and adding details which will make the puppets appear more lifelike.

**XXXV.  
DOUBLE BELLOWS.**

The small-sized bellows which have become popular in sitting-rooms are usually more ornamental than efficient, and make one think regretfully of the old-fashioned article of ample capacity which is seldom seen nowadays.

Fig. 185 illustrates a method of coupling up two small bellows in such a manner as to provide an almost continuous blast, besides doubling the amount of air sent through the fire in a given time, at the cost of but little extra exertion. A piece of wood half an inch thick is screwed across one bellows just behind the valve hole. The two bellows are then laid valve facing valve, and are attached to one another by a strip of tin passed round the wood just behind the nozzles and by tying the two fixed handles together.

Make a rectangle of stout wire somewhat wider

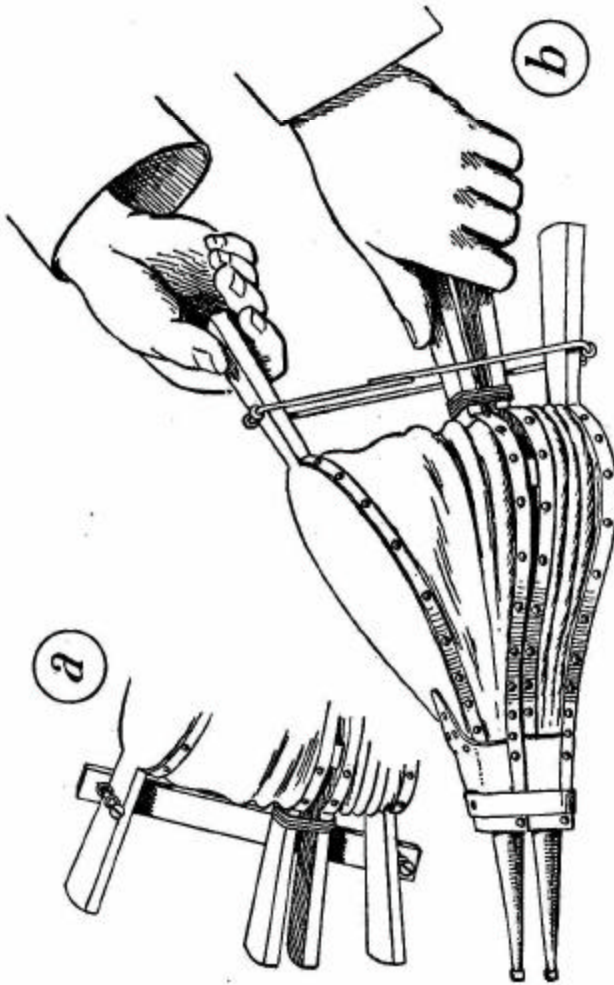

FIG. 185.—Double-acting bellows. Two methods of coupling shown.

FIG. 185. -- Double-acting bellows.  
Two methods of coupling shown.



than the handles and long enough to reach from the outer face of one moving handle to that of the other, when one bellows is quite closed and the other full open. The ends of the wire should be soldered together, and the ends of the link held up to the handles by a couple of staples.

An alternative method is to use a piece of wood with a screw driven into it at right angles near each end through the staples on the handles (Fig. 185, *a*). In place of the staples you may use screw-in eyes fitting the screws.

**XXXVI.**  
**A HOME-MADE PANTOGRAPH.**

The pantograph is a simple apparatus for copying drawings, maps, designs, etc., on a reduced or enlarged scale, or to the same size as the original.

A sketch of a pantograph is given in Fig. 186.

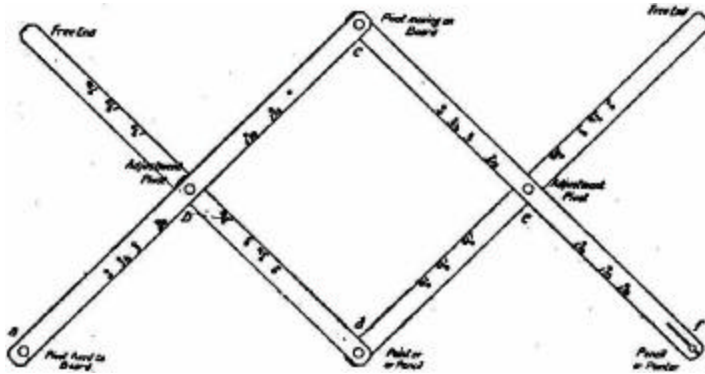

FIG. 186. -- Details of simple pantograph.

Four rods are jointed together to form a parallelogram, the sides of which can be lengthened or shortened to suit the scale of reproduction. One is attached by a fixed pivot at *a* to the board on which the drawing

is done. At *b* and *e* are removable pivots, used for adjusting the rods; at *c* is a pivot which projects an inch or so below the rods. The pointer is inserted at *d* for enlargement, or at *f* for reduction, the pencil being in the unoccupied hole at *d* or *f*.

If a same-sized copy is desired, the fixed pivot is transferred to *d*, and the pencil and pointer placed at *a* and *f* respectively.

**Construction of an Enlarging and Reducing Pantograph. --**

Cut out of 1/8-inch oak, walnut, or beech four rods 5/8 inch wide and 19 inches long. Smooth them well all over, and make marks near the ends of each, exactly 18 inches apart. The graduation of the rods for the adjustment pivot holes is carried out in accordance with the measurements given in Fig. 187. It is advisable to mark out and bore each rod separately if you do not possess a machine which will drill holes quite perpendicularly; if you do, all four rods can be drilled at one operation.

In Fig. 187 the lower row of numerals indicates the number of times (in diameters) the original is enlarged when all four holes similarly figured are used; the upper row, the size of the copy as compared with the original in case of reduction.

If proportions other than those given are required,

a very little calculation will locate the necessary holes.

**Pivots.** -- All the pivots must fit their holes accurately, as any looseness at the joints detracts from the truth of reproduction. For pivots *b* and *e* may use brass screws and small pieces of hard wood as nuts to hold them in position. The nuts should screw on rather stiffly, and not be forced hard against the rods, as free motion with little friction at all joints is essential for good work.

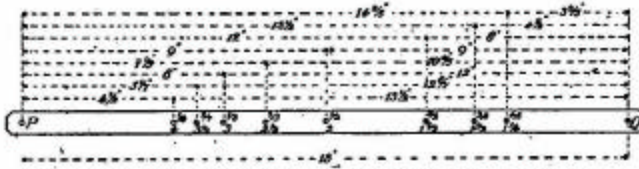

FIG. 187.—Diagram showing how to mark off pantograph rods. The dotted lines above rod give distances of holes from ends.

FIG. 187. -- Diagram showing how to mark off pantograph rods. The dotted lines above rod give distances of holes from ends.

The fixed pivot at *a* may be merely the shank of a wire nail of the proper size driven into the board, a cork collar being slipped over it to keep the rod the proper distance from the board. For *c* use a screw to the head of which has been soldered half an inch of a round-headed brass nail, which will move easily over the paper. At *d* is needed a hollow pivot, fashioned out of a quarter of an inch of pencil-point protector or some other thin tube, burred over slightly

at the ends so as not to fall out. The end of B at *f* has a slotted hole to grip the pencil or pointer, as the case may be.

**A Same-size Pantograph.** -- For making a same-size copy, tracing may be preferred to the use of a pantograph; but if a pantograph is adopted, a special apparatus may be constructed for the purpose. The arrangement is exactly the same as that already described, excepting that the only holes needed are those at *a*, *c*, *d*, *f*, at the middle points of the four rods, the parallelogram formed by the rods being equal-sided. The fixed pivot is situated at *d*, and pencil and pointer holes are made at *a* and *f*.

**Using the Pantograph.** -- When adjusting the instrument for reduction or enlargement, make sure that the adjustment pivots are in the holes corresponding with the scale. The fixed pivot, pointer, and pencil must be rigid, and, with pivot *c*, be of such a length that the pantograph as a whole moves parallel to the paper. A little sliding weight to place on the rod near the pencil will be found useful for keeping the pencil point in constant contact with the paper.

If the apparatus works stiffly, ease the holes a trifle and lead-pencil the wood at all points where two

surfaces rub. It is absolutely impossible to make a good reproduction with a stiff, jerky pantograph.

To decide the positions of original and the paper for the copy, get the pointer centred on the original and adjust the paper till its centre is under the pencil.

**XXXVII.**  
**A SILHOUETTE DRAWING MACHINE.**

With this very simple apparatus you will be able to give good entertainment to such of your friends as may wish to have black paper records of their faces in profile.

The machine is merely a long rod, with a sliding pencil attached to one end and a metal pointer stuck into the other, supported near the pencil end on a pivot which permits free movement in all directions.

For heads and busts only, the rod and pointer combined need not be more than 4 feet 6 inches long. The rod is a 1/2-inch blind rod, the pointer a stout knitting-needle driven axially into one end of the rod. This pointer, being of small diameter, follows the minor curves and angles of the features much more closely than would be possible with the rod.

The support is a piece of wood, 1-1/2 inches square and 12 to 15 inches long, screwed on to a large foot, which should be fairly heavy, as any tilting or slipping will, of course, spoil the silhouette. The universal joint for the rod is made by soldering a small U-shaped piece of metal to the end of a short metal bar. The ends of the U are drilled for a pin passing through the rod; and a hole is sunk into the top of the support to take the bar. The fit should be close, to prevent the pivot rocking about, and the hole in the support deep enough to bring the bottom of the stirrup down against the wood.

If a series of holes half an inch apart is drilled, through the rod, the nearest 9 inches from the pencil end, the size of the silhouette proportionately to the original can be varied by moving the pin from one hole to another.

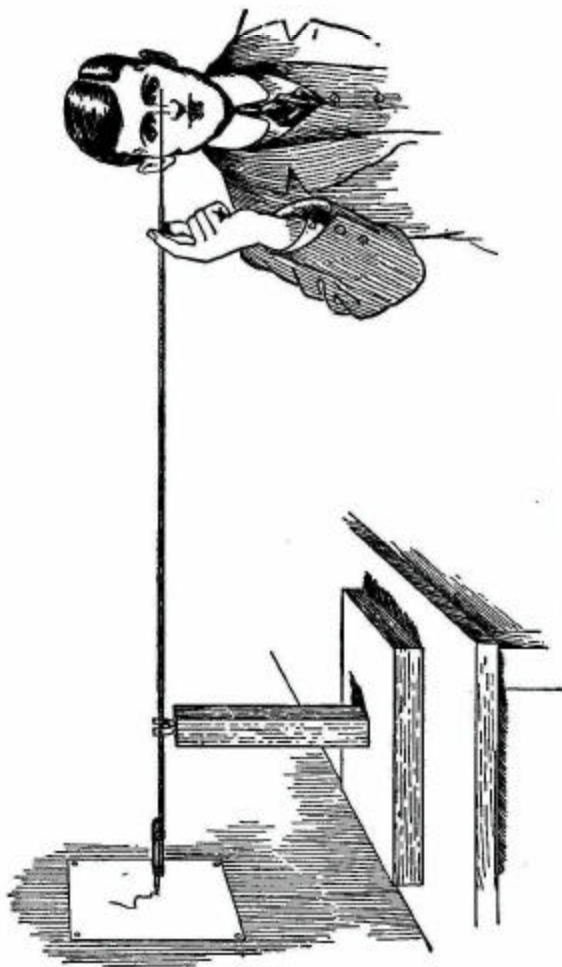

FIG. 188.—Silhouettograph in use.

FIG. 188. -- Silhouettograph in use.



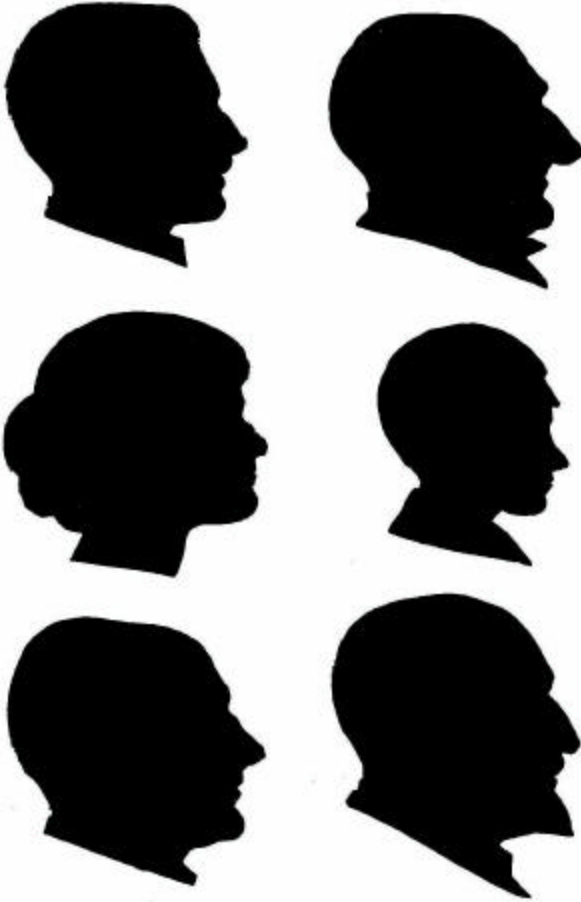

FIG. 188a.—Group of silhouettes drawn with the machine described.

FIG. 188a. -- Group of silhouettes drawn with the machine described.

The *pencil holder* is 4 inches of tubing, in which the pencil can slide easily without shaking. If necessary, the size of the pencil should be reduced by rubbing with glass paper. Bind the holder tightly to the end of the rod away from the pointer, so that one extremity just overhangs the rod. A piece of thin elastic is tied to the unsharpened end of the pencil and to the pencil tube, the adjustment allowing the pencil to project an inch when the elastic is taut but not stretched.

A fairly soft pencil and a thick, smooth paper or card give the best results. Paper should be backed by something hard to prevent the pencil digging in. Attach the paper to a firm vertical surface, such as the side of a box, a drawing board, a wall, etc.

**Using the Machine.** -- The rod support, paper, and sitter should be arranged so that the rod is level at the height of the sitter's nose and the pencil on the centre of the paper. Bring the support near enough to the paper to drive the pencil back into the tube until the point projects only half an inch.

A thread attached to the pencil will enable you to keep the pencil off the paper until you wish to begin drawing the profile.

Begin with the pointer pressing against the sitter's chest, and bring it over the face and down the back of the head and neck. Do not press it into the hair, but carry it along what you consider to be the outline; though it must be in actual contact with the features and clothes. It is hardly necessary to mention that the sitter must keep perfectly still if the silhouette is to be at all accurate.

The tracing is cut round with fine-pointed scissors,

and the paper blacked and stuck on a piece of white card. Some trouble is saved by using paper white on one aide and black on the other. If duplicates are needed, two or more pieces of paper should be stuck together by the corners and to the paper on which the silhouette is drawn, and all be cut through at one operation.

With a little practice the actual tracing of the outline occupies but a few seconds. Things are expedited if an assistant adjusts the paper and pencil.

**XXXVIII.**  
**A SIGNALLING LAMP.**

Visual signalling is effected at night in the Morse code by means of a lamp fitted with an easily-moved shutter, which passes or cuts off the light at the will of the operator. Readers who know the Morse code might well go to the trouble of constructing in duplicate the simple apparatus to be described, as the possession of an outfit will enable them to extend their signalling capabilities.

The stand for the lamp is admirably supplied by the ordinary camera tripod. For the illuminant we may select any good acetylene cycle lamp.

For this a holder is made of 1/2-inch wood, according to the sketch shown in Fig. 189. The width of all the four parts should be about 2 inches greater than the front glass of the lamp. B and C should be sufficiently far apart to allow the lamp to rest on the rim above the carbide chamber; and

the front, A, should be at least an inch higher than the top of the lamp glass.

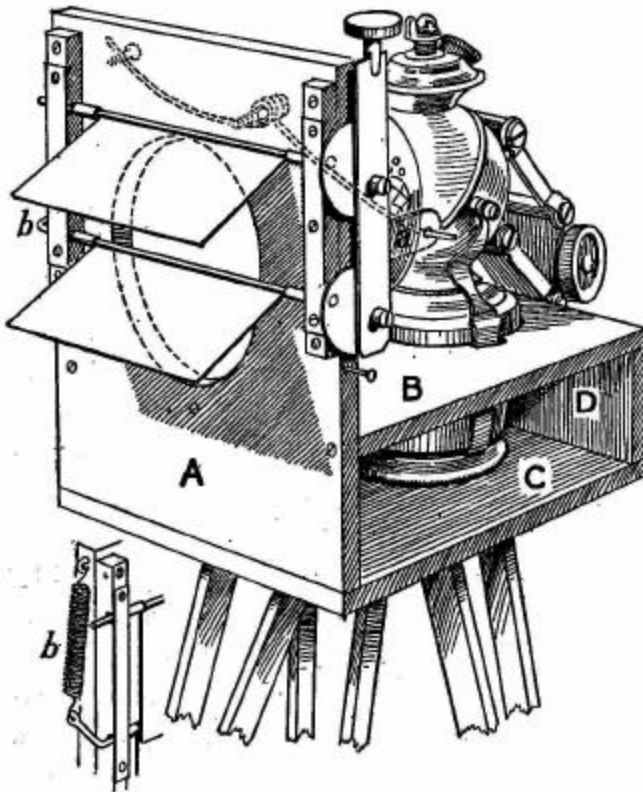

FIG. 189.—Signalling lamp with quick-moving shutter.

FIG. 189. -- Signalling lamp with quick-moving shutter.

The hole cut in B must be so situated as to bring the front of the lamp close to the front of the holder,

so that the greatest possible amount of light may be utilized. The hole in A should be rather larger than the lamp front, and, of course, be accurately centred. Mark these two holes off carefully, and cut out with a pad saw or fret saw.

A socket must be attached to the centre of the underside of the base to take the camera screw; or, if such a socket is not easily obtainable, a hole should be drilled in the base to take an ordinary wood screw of good size, the surplus of which is cut off so as not to interfere with the lamp.

**The Shutter.** -- The woodwork is so simple that nothing further need be said about it. The more difficult part of the business is the making of the shutter, which must be so constructed that it can be opened and closed rapidly by motions similar to those used in working the telegraph key described in a preceding chapter. Speed of working is obtained by dividing the shutter into two or three parts, each revolving on its own spindle, but all connected so as to act in perfect unison. The thinnest sheet brass or iron obtainable should be used, so that the tension of the spring used to close the shutter need not be great. Our illustration shows a two-part shutter, each half an inch wider than the hole in the front,

and jointly a similar amount deeper. The upper half overlaps the lower, outside, by a quarter of an inch.

The spindles are two straight pieces of brass wire, revolving in sockets which are most easily made of notched pieces of wood (as shown in Fig. 189), with removable caps of strip tin. The lower spindle should be an inch longer than the width of the front, to allow for a cranked end, to which the closing spring will be attached.

Having cut out the halves of the shutter, solder the spindle wires to one edge of each on what will be the back side. The wires must be so arranged as to allow a quarter of an inch to project beyond the left edge of the front, as the opening mechanism is situated on this side as the most convenient for the operator.

Take a couple of metal discs, an inch or so in diameter, and bore a hole in each near the circumference to fit the ends of the pivots fairly tight. Three-eighths of an inch from this--centre to centre--bore and tap a hole for a small screw. The tapping should be done with a taper tap and carried just so far that the screw turns stiffly without danger of being broken off by the screw-driver.

Next find the correct positions of the parts of the

shutter and the spindle sockets on the front of the holder, and mark them off carefully. Screw the wooden parts of the sockets to the front. Four little "distance pieces" should now be cut out of small tubing, or made by twisting tin round the spindle, to place on the spindles between shutter and sockets, so that the shutters cannot shift sideways.

The right-hand end of the lower spindle must be bent over (after slipping on the distance piece) to form a 1/2-inch crank making an angle of 45 degrees with the line of the front, in an *upward* direction, as it will be depressed by the opening of the shutter. Flatten out the end with a hammer, and drill a small hole near the tip.

The shutters can now be placed in position, and the caps of the sockets be screwed on. The next thing to make is the connecting rod to join the cranks at the left side of the front. For this purpose we may use a piece of fairly stiff strip metal--brass by preference--5 or 6 inches long. Half an inch from one end make a mark with the centre punch; then measure off exactly the distance between the shutter spindles, and make a second punch mark. Drill holes at the marks large enough, for the disc screws to pass through easily, but not loosely.



Attach the rod to the discs by the screws, and slip the discs on to the ends of the shutter spindles. (The free end of the rod should be upwards.) Press the shutters against the front so that they cannot open, adjust the discs at an angle of 45 degrees to the front in an upward direction, and solder them firmly to the spindles.

The upper end of the connecting rod should be turned over to form a finger rest, or be sharpened off to take a knob. The last operation is the fitting of the spring to close the shutter. A spiral spring attached at one end of the crank on the lower spindle and at the other to a nail projecting from the side of the front is the most convenient arrangement. If you have not got a spiral spring, you can easily make a fairly efficient substitute out of hard brass wire wound a few times round a large wire nail.

An alternative method of springing is to add an arm, *a*, to the connecting rod, as shown by dotted lines in Fig. 189, and to use the projection for engaging a spring, made by winding hard brass wire a few times round a nail. A screw passed through the coil holds it to the front.

The tension of the spring must be just sufficient to close the shutter smartly and prevent it rebounding far enough to pass any light.

**XXXIX.**  
**A MINIATURE GASWORKS.**

The most primitive method of making coal gas on a small scale is to fill a tin--which must have folded, not soldered, joints--with small coal, punch a hole in the bottom, and place it lid downwards in the fire. Gas soon begins to issue, but, owing to the quantity of moisture and impurities present, it will not ignite until some minutes have elapsed. The flame, when it does make its appearance, is very smoky and gives little light, because, in addition to the coal gas of commerce, there are present ammonia gas, sulphuretted hydrogen, carbonic acid, tar vapour, etc., which prevent brightness of flame.

A miniature gasworks, if it is to be worthy of its name, must obviously endeavour to separate the troublesome components from the useful gas. The doing of this involves several processes, all simple enough in principle, and requiring but simple apparatus

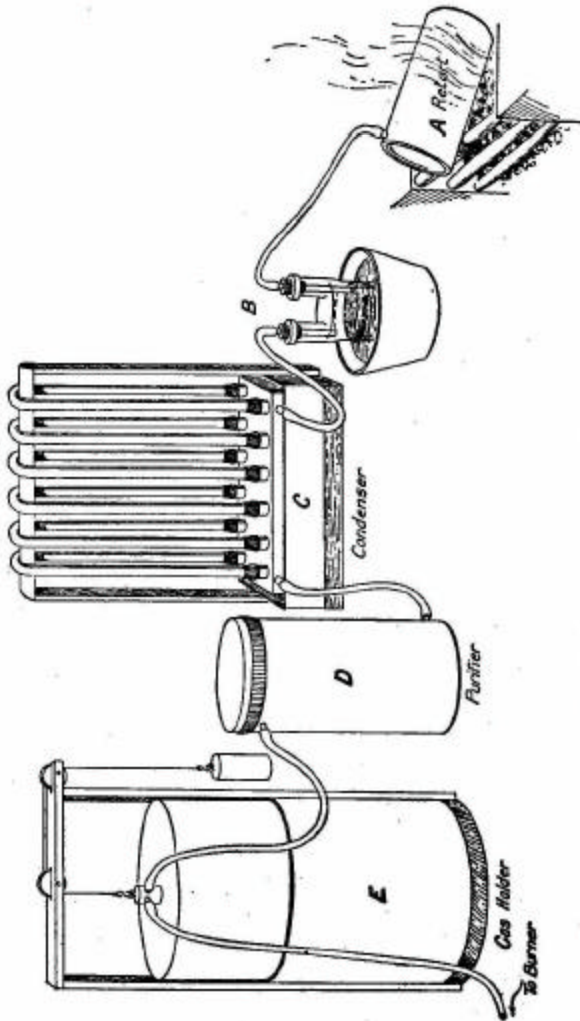

FIG. 190.—General view of gas-making apparatus.

FIG. 190. -- General view of gas-making apparatus.

for demonstration on a small scale. To take them in order the processes are--

- (1) the formation of gas in a retort;
- (2) the condensation of the tar;
- (3) the condensation of steam;
- (4) the removal of the ammonia gas;
- (5) the removal of the sulphuretted hydrogen and carbonic acid.

The last two processes are, in a real gasworks, usually separated, but for simplicity's sake we will combine them. Finally, the storage of the gas has to be provided for.

**The Retort.** -- To get very good results, the retort should be of cast iron, and have a removable air-tight cover; but, to keep down expense, we will use an ordinary 2-pound self-opening coffee tin. A short piece of brass pipe is soldered into the lid near one edge to carry off the gas as it is generated. To get a fairly gas-tight joint, red-leaded asbestos string should be rammed tightly between the lid and the tin. The tin may be laid on an open fire on the slant, the lid end uppermost, and the pipe at the top, where the gas will collect; or, if you wish to make things more realistic, you may easily construct an oven with sides and back of fire-brick, and front of sheet iron, through the hole in which the tin is pushed horizontally, so that only half an inch projects. This is a suitable arrangement for out of doors.

**The Hydraulic Main.** -- This is represented in Fig. 190 by a double-necked bottle, B, standing in a bowl of cold water. The pipe from the retort passes through the cork in one neck and dips half an inch below the surface of the water inside. The gas, on meeting the water, is cooled, and some of the steam in it is condensed, also most of the tar present, which floats on the top of the water. From the bottle the gas passes on to

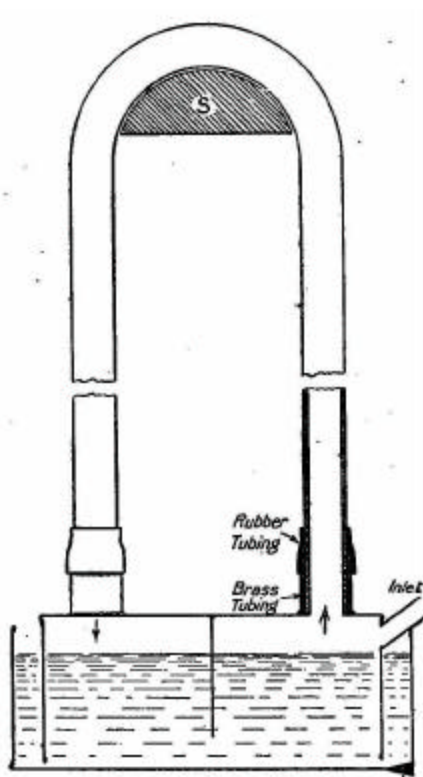

FIG. 191.—Vertical section of condenser.

FIG. 191. -- Vertical section of condenser.

**the Condensers**, where the process of cooling is completed gradually. The condenser (Fig. 191) is so

designed as to cause the gas to pass through several pipes in succession. The base consists of a tin box, 6 inches long, 4 wide, and 1-3/4 deep. This is divided longitudinally down the centre by a 1-1/2-inch partition, soldered to the bottom and sides; and the two divisions are again subdivided, as shown in Fig. 192, by shorter cross partitions.

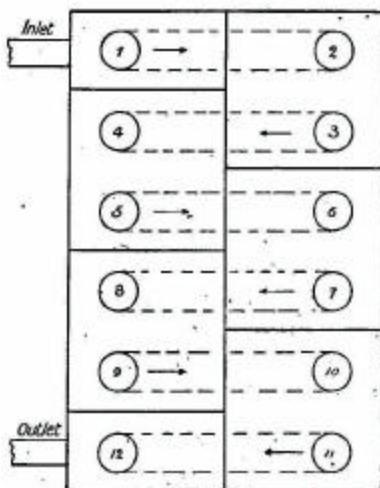

FIG. 192.—Plan of condenser.

FIG. 192. -- Plan of condenser.

For the condensing pipes, "compo" tubing of 1/2-inch outside diameter is convenient. The amount required will, of course, depend on the number of pipes used and the length of the individual pipes. The design shows 6 pipes, each 3 feet long, bent to a semicircular curve (Fig. 191) at the middle to form very long, narrow horse-shoes. The pipes are supported at the curve by the crossbar, S (Fig. 191), of a frame, and their ends enter short pieces of brass tubing soldered into holes in the

bottom of the tin box. Rubber bands make the joints air-tight.

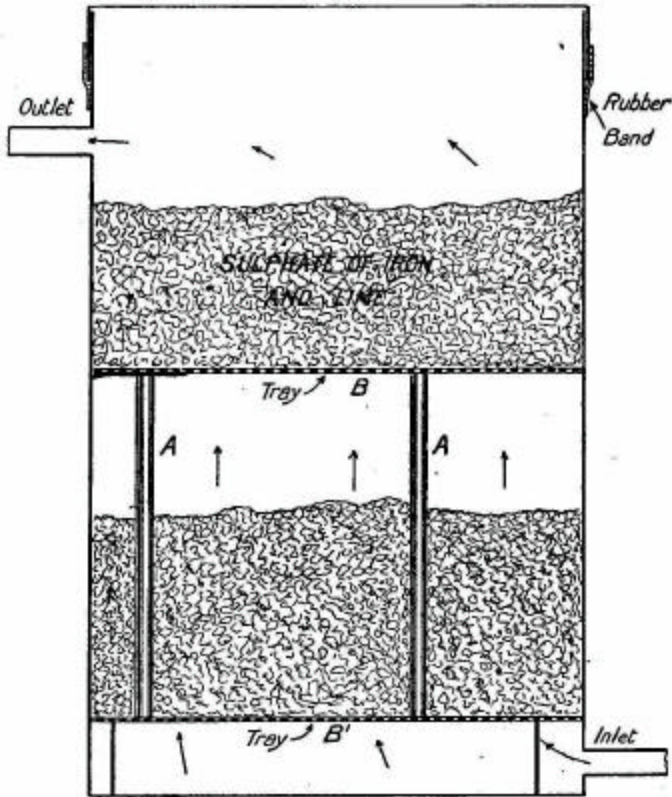

FIG. 193.--Vertical section of purifier.

FIG. 193. -- Vertical section of purifier.

The base is stood bottom upwards in a larger tin containing an inch and a half of water. The water acts as a seal, preventing the passage of the gas

from one compartment to another through the pipes which it traverses, in the order indicated by the arrows and numbers in Fig. 192, to reach the outlet. On its way the gas is deprived of any water and of any traces of tar. The condensed water and tar fall from the open ends of the pipes into the base.

**The Purifier** is made of a large tin with overlapping lid. Near the bottom is soldered on an inlet pipe; just below the lid an outlet pipe. Cut out two discs of perforated zinc or sheet tin to fit inside the tin easily, but not loosely. (If tin is used, make a number of small holes in it.) The lower of the discs (Fig. 193, B1) has three wire legs, AA, soldered to it, to support the upper disc, B. Three short supports keep it clear of the bottom.

The tin must be charged with a mixture of two parts green sulphate of iron and one part lime. The lime should be slaked a short time before use. The sulphate, lime, and sufficient water to moisten the whole are ground into a pulp and left to dry. The dry mixture, which has a reddish-yellow colour, is broken up fine. Put tray B1 into place and spread half the chemical over it; then lay B on the top and cover it with the remainder. The lid joint is sealed by a broad rubber band.



While passing through the tin, the ammonia, sulphuretted hydrogen and carbonic acid gases all combine with the chemical, and fairly pure gas issues from the outlet.

**The Gasholder.** -- As the gasometer is an important feature of a gasworks, our small plant should contain its counterpart, as it serves to regulate the pressure of the gas, and, therefore, the steadiness of the flame, as well as affording storage room.

As a gasometer, one may use a container made on the principle of the lung-testing apparatus described on p. 361; or the gasholder of a lantern acetylene apparatus, which must, of course, be suitably counterweighted.

**Working the Plant.** -- When starting up the plant, leave the burner open until inflammable gas issues, so that the air present in the various chambers may be displaced.

[Transcribers note: Premature lighting of the burner may cause the flame to propagate into the system and explode. I speak from experience.]

**INDEX.**

- Aeroplane, model self-launching, 296-310.  
Bedplate for engine, 140.  
Bellows, double, 402-404.  
Bench, joiner's, 13-22.  
Benham's harmonograph, 370.  
Bicycle shed, 49-64.  
Boilers, model, 195-223.  
Bookstand, 28-26.  
Box kites, 267-283.
- Cabinets, cardboard, 70-73;  
    cigar-box, 74-78;  
    match-box, 68-70;  
    tool, 78-82.
- Circles, rolling, 312.  
Clock, electric alarm, 103-108.  
Colour top, 816.  
Cylinder, double-acting steam, 141-150.
- Developing sink, 83-88.  
Doors for shed, 58.  
Double-acting horizontal steam engine, 136-164.  
Double bellows, 402-404.
- Eccentrics, 153, 155.  
Electric alarm clock, 103-108.  
Electric motor, reciprocating, 95-102.  
Electric railway, 109-126.  
Engine, hot-air, 282-246.  
Experiments, apparatus for simple scientific, 311-326.
- Fuels for model boilers, 221, 222

Gasworks, miniature, 421-428

Ganges, rain, 327-333;

    steam, 217;

    water, 217.

Gimbals, or universal joints, 373.

Gliders, paper, 290-295.

Goold's harmonograph, 369.

Governor for engine, 159-163.

Harmonographs, 364-388.

Hot-air engines, 282-246.

House ladder, 27-82.

Joiner's bench, 1322.

Kettles, quick-boiling, 224-231.

Kites, box, 267-288.

Kite winders, 284-289.

Ladder, house, 27-32.

Lamp, signalling, 415-420.

Locomotive, electric, 119-123.

Lung-testing apparatus, 353-363.

Magic swingers, 319-323 ;

    windmill, 317.

Match-boarding, 53.

Match-box, self-supplying, 389-393.

Morse code, 84

Morse sounder, 90.

Motor, electric, 95-102.

Motor, water, 247-254.

Nozzle for steam turbine, 182.

- Pantograph, 405-409.
- Pendulums for harmonograph, 371.
- Pens for harmonograph, 379.
- Pneumatic puzzle, 319.
- Poultry house 39-48.
- Propellers for aeroplane, 307.
- Pumps, 158, 169, 218; 255-266
- Puppets, wrestling, 398-401.
- Puzzle, pneumatic, 319.
  
- Railway, electric, 109-126.
- Rain gauges, 327-333.
- Reciprocating steam engine, simple, 127-135.
- Resistance, adjustable, for electric railway, 125.
- Reversing switch for electric railway, 123.
- Riveting, 197.
  
- Safety Valves, 216.
- Sawing trestle, 7-12.
- Shed for bicycle, 49-64.
- Signalling lamp, 415-420.
- Silhouette drawing machine, 410-414.
- Simple scientific experiments, 311-326.
- Sink, developing, 38-38.
- Slide valve, 150, 155.
- Smoke-ring apparatus, 324-326.
- Soldering, 197, 198.
- Spokes, magic, 815.
- Steam cocks, 219.
- Steam engines, 127-168.
- Steam gauge, 217.
- Steam pump, 258-266
- Steam tops, 187-194.
- Steam turbines, 165-186.
- Strength. testing machines, 345-352
- Swingers, magic, 319-323.
- Switch, multiple battery, 124
- Switch, reversing, 123

Target apparatus, 65-67.  
Telegraphic apparatus, 83-94  
Testing boilers, 220.  
Tool cabinet, 78-82.  
Top, colour, 316.  
Tops, steam, 187-194.  
Track for model railway, 111-118  
Trestle, sawing, 7-12.  
Turbines, model steam, 165-186.

Vanishing spiral, 312,  
Vice for Joiner's bench, 21

Water gauge, 211,218.  
Water motor, 247-254.  
Weights for harmonograph pendulums, 314.  
Windmill, magic, 317.  
Wind vanes, 334-344; electric, 339-343  
Workbox, Norwegian, 394-398  
Wrestling puppets, 398-401.  
Wriggling line, 313.

THE END.

PRINTED IN GREAT BRITAIN AT THE PRESS OF THE  
PUBLISHERS.

End of the Project Gutenberg EBook of Things To Make, by Archibald Williams

\*\*\* END OF THIS PROJECT GUTENBERG EBOOK THINGS TO MAKE \*\*\*

\*\*\*\*\* This file should be named 14664-pdf.pdf or 14664-pdf.zip \*\*\*\*\*  
This and all associated files of various formats will be found in:  
<http://www.gutenberg.net/1/4/6/6/14664/>

Produced by Don Kostuch

Updated editions will replace the previous one--the old editions will be renamed.

Creating the works from public domain print editions means that no one owns a United States copyright in these works, so the Foundation (and you!) can copy and distribute it in the United States without permission and without paying copyright royalties. Special rules, set forth in the General Terms of Use part of this license, apply to copying and distributing Project Gutenberg-tm electronic works to protect the PROJECT GUTENBERG-tm concept and trademark. Project Gutenberg is a registered trademark, and may not be used if you charge for the eBooks, unless you receive specific permission. If you do not charge anything for copies of this eBook, complying with the rules is very easy. You may use this eBook for nearly any purpose such as creation of derivative works, reports, performances and research. They may be modified and printed and given away--you may do practically ANYTHING with public domain eBooks. Redistribution is subject to the trademark license, especially commercial redistribution.

\*\*\* START: FULL LICENSE \*\*\*

THE FULL PROJECT GUTENBERG LICENSE  
PLEASE READ THIS BEFORE YOU DISTRIBUTE OR USE THIS WORK

To protect the Project Gutenberg-tm mission of promoting the free distribution of electronic works, by using or distributing this work (or any other work associated in any way with the phrase "Project Gutenberg"), you agree to comply with all the terms of the Full Project Gutenberg-tm License (available with this file or online at <http://gutenberg.net/license>).

Section 1. General Terms of Use and Redistributing Project Gutenberg-tm electronic works

1.A. By reading or using any part of this Project Gutenberg-tm electronic work, you indicate that you have read, understand, agree to and accept all the terms of this license and intellectual property (trademark/copyright) agreement. If you do not agree to abide by all the terms of this agreement, you must cease using and return or destroy all copies of Project Gutenberg-tm electronic works in your possession. If you paid a fee for obtaining a copy of or access to a Project Gutenberg-tm electronic work and you do not agree to be bound by the terms of this agreement, you may obtain a refund from the person or entity to whom you paid the fee as set forth in paragraph 1.E.8.

1.B. "Project Gutenberg" is a registered trademark. It may only be used on or associated in any way with an electronic work by people who agree to be bound by the terms of this agreement. There are a few things that you can do with most Project Gutenberg-tm electronic works even without complying with the full terms of this agreement. See paragraph 1.C below. There are a lot of things you can do with Project Gutenberg-tm electronic works if you follow the terms of this agreement and help preserve free future access to Project Gutenberg-tm electronic works. See paragraph 1.E below.

1.C. The Project Gutenberg Literary Archive Foundation ("the Foundation" or PGLAF), owns a compilation copyright in the collection of Project Gutenberg-tm electronic works. Nearly all the individual works in the collection are in the public domain in the United States. If an individual work is in the public domain in the United States and you are located in the United States, we do not claim a right to prevent you from copying, distributing, performing, displaying or creating derivative works based on the work as long as all references to Project Gutenberg are removed. Of course, we hope that you will support the Project Gutenberg-tm mission of promoting free access to electronic works by freely sharing Project Gutenberg-tm works in compliance with the terms of this agreement for keeping the Project Gutenberg-tm name associated with the work. You can easily comply with the terms of this agreement by keeping this work in the same format with its attached full Project Gutenberg-tm License when you share it without charge with others.

1.D. The copyright laws of the place where you are located also govern what you can do with this work. Copyright laws in most countries are in a constant state of change. If you are outside the United States, check the laws of your country in addition to the terms of this agreement before downloading, copying, displaying, performing, distributing or creating derivative works based on this work or any other Project Gutenberg-tm work. The Foundation makes no representations concerning the copyright status of any work in any country outside the United States.

1.E. Unless you have removed all references to Project Gutenberg:

1.E.1. The following sentence, with active links to, or other immediate access to, the full Project Gutenberg-tm License must appear prominently whenever any copy of a Project Gutenberg-tm work (any work on which the phrase "Project Gutenberg" appears, or with which the phrase "Project Gutenberg" is associated) is accessed, displayed, performed, viewed, copied or distributed:

This eBook is for the use of anyone anywhere at no cost and with almost no restrictions whatsoever. You may copy it, give it away or re-use it under the terms of the Project Gutenberg License included with this eBook or online at [www.gutenberg.net](http://www.gutenberg.net)

1.E.2. If an individual Project Gutenberg-tm electronic work is derived from the public domain (does not contain a notice indicating that it is posted with permission of the copyright holder), the work can be copied and distributed to anyone in the United States without paying any fees or charges. If you are redistributing or providing access to a work with the phrase "Project Gutenberg" associated with or appearing on the work, you must comply either with the requirements of paragraphs 1.E.1 through 1.E.7 or obtain permission for the use of the work and the Project Gutenberg-tm trademark as set forth in paragraphs 1.E.8 or

1.E.9.

1.E.3. If an individual Project Gutenberg-tm electronic work is posted with the permission of the copyright holder, your use and distribution must comply with both paragraphs 1.E.1 through 1.E.7 and any additional terms imposed by the copyright holder. Additional terms will be linked to the Project Gutenberg-tm License for all works posted with the permission of the copyright holder found at the beginning of this work.

1.E.4. Do not unlink or detach or remove the full Project Gutenberg-tm License terms from this work, or any files containing a part of this work or any other work associated with Project Gutenberg-tm.

1.E.5. Do not copy, display, perform, distribute or redistribute this electronic work, or any part of this electronic work, without prominently displaying the sentence set forth in paragraph 1.E.1 with active links or immediate access to the full terms of the Project Gutenberg-tm License.

1.E.6. You may convert to and distribute this work in any binary, compressed, marked up, nonproprietary or proprietary form, including any word processing or hypertext form. However, if you provide access to or distribute copies of a Project Gutenberg-tm work in a format other than "Plain Vanilla ASCII" or other format used in the official version posted on the official Project Gutenberg-tm web site ([www.gutenberg.net](http://www.gutenberg.net)), you must, at no additional cost, fee or expense to the user, provide a copy, a means of exporting a copy, or a means of obtaining a copy upon request, of the work in its original "Plain Vanilla ASCII" or other form. Any alternate format must include the full Project Gutenberg-tm License as specified in paragraph 1.E.1.

1.E.7. Do not charge a fee for access to, viewing, displaying, performing, copying or distributing any Project Gutenberg-tm works unless you comply with paragraph 1.E.8 or 1.E.9.

1.E.8. You may charge a reasonable fee for copies of or providing access to or distributing Project Gutenberg-tm electronic works provided that

- You pay a royalty fee of 20% of the gross profits you derive from the use of Project Gutenberg-tm works calculated using the method you already use to calculate your applicable taxes. The fee is owed to the owner of the Project Gutenberg-tm trademark, but he has agreed to donate royalties under this paragraph to the Project Gutenberg Literary Archive Foundation. Royalty payments must be paid within 60 days following each date on which you prepare (or are legally required to prepare) your periodic tax returns. Royalty payments should be clearly marked as such and sent to the Project Gutenberg Literary Archive Foundation at the address specified in Section 4, "Information about donations to the Project Gutenberg Literary Archive Foundation."
- You provide a full refund of any money paid by a user who notifies you in writing (or by e-mail) within 30 days of receipt that s/he does not agree to the terms of the full Project Gutenberg-tm License. You must require such a user to return or destroy all copies of the works possessed in a physical medium and discontinue all use of and all access to other copies of Project Gutenberg-tm works.



- You provide, in accordance with paragraph 1.F.3, a full refund of any money paid for a work or a replacement copy, if a defect in the electronic work is discovered and reported to you within 90 days of receipt of the work.
- You comply with all other terms of this agreement for free distribution of Project Gutenberg-tm works.

1.E.9. If you wish to charge a fee or distribute a Project Gutenberg-tm electronic work or group of works on different terms than are set forth in this agreement, you must obtain permission in writing from both the Project Gutenberg Literary Archive Foundation and Michael Hart, the owner of the Project Gutenberg-tm trademark. Contact the Foundation as set forth in Section 3 below.

#### 1.F.

1.F.1. Project Gutenberg volunteers and employees expend considerable effort to identify, do copyright research on, transcribe and proofread public domain works in creating the Project Gutenberg-tm collection. Despite these efforts, Project Gutenberg-tm electronic works, and the medium on which they may be stored, may contain "Defects," such as, but not limited to, incomplete, inaccurate or corrupt data, transcription errors, a copyright or other intellectual property infringement, a defective or damaged disk or other medium, a computer virus, or computer codes that damage or cannot be read by your equipment.

1.F.2. LIMITED WARRANTY, DISCLAIMER OF DAMAGES - Except for the "Right of Replacement or Refund" described in paragraph 1.F.3, the Project Gutenberg Literary Archive Foundation, the owner of the Project Gutenberg-tm trademark, and any other party distributing a Project Gutenberg-tm electronic work under this agreement, disclaim all liability to you for damages, costs and expenses, including legal fees. YOU AGREE THAT YOU HAVE NO REMEDIES FOR NEGLIGENCE, STRICT LIABILITY, BREACH OF WARRANTY OR BREACH OF CONTRACT EXCEPT THOSE PROVIDED IN PARAGRAPH F3. YOU AGREE THAT THE FOUNDATION, THE TRADEMARK OWNER, AND ANY DISTRIBUTOR UNDER THIS AGREEMENT WILL NOT BE LIABLE TO YOU FOR ACTUAL, DIRECT, INDIRECT, CONSEQUENTIAL, PUNITIVE OR INCIDENTAL DAMAGES EVEN IF YOU GIVE NOTICE OF THE POSSIBILITY OF SUCH DAMAGE.

1.F.3. LIMITED RIGHT OF REPLACEMENT OR REFUND - If you discover a defect in this electronic work within 90 days of receiving it, you can receive a refund of the money (if any) you paid for it by sending a written explanation to the person you received the work from. If you received the work on a physical medium, you must return the medium with your written explanation. The person or entity that provided you with the defective work may elect to provide a replacement copy in lieu of a refund. If you received the work electronically, the person or entity providing it to you may choose to give you a second opportunity to receive the work electronically in lieu of a refund. If the second copy is also defective, you may demand a refund in writing without further opportunities to fix the problem.

1.F.4. Except for the limited right of replacement or refund set forth in paragraph 1.F.3, this work is provided to you 'AS-IS' WITH NO OTHER WARRANTIES OF ANY KIND, EXPRESS OR IMPLIED, INCLUDING BUT NOT LIMITED TO WARRANTIES OF MERCHANTABILITY OR FITNESS FOR ANY PURPOSE.

1.F.5. Some states do not allow disclaimers of certain implied warranties or the exclusion or limitation of certain types of damages. If any disclaimer or limitation set forth in this agreement violates the law of the state applicable to this agreement, the agreement shall be interpreted to make the maximum disclaimer or limitation permitted by the applicable state law. The invalidity or unenforceability of any provision of this agreement shall not void the remaining provisions.

1.F.6. INDEMNITY - You agree to indemnify and hold the Foundation, the trademark owner, any agent or employee of the Foundation, anyone providing copies of Project Gutenberg-tm electronic works in accordance with this agreement, and any volunteers associated with the production, promotion and distribution of Project Gutenberg-tm electronic works, harmless from all liability, costs and expenses, including legal fees, that arise directly or indirectly from any of the following which you do or cause to occur: (a) distribution of this or any Project Gutenberg-tm work, (b) alteration, modification, or additions or deletions to any Project Gutenberg-tm work, and (c) any Defect you cause.

## Section 2. Information about the Mission of Project Gutenberg-tm

Project Gutenberg-tm is synonymous with the free distribution of electronic works in formats readable by the widest variety of computers including obsolete, old, middle-aged and new computers. It exists because of the efforts of hundreds of volunteers and donations from people in all walks of life.

Volunteers and financial support to provide volunteers with the assistance they need, is critical to reaching Project Gutenberg-tm's goals and ensuring that the Project Gutenberg-tm collection will remain freely available for generations to come. In 2001, the Project Gutenberg Literary Archive Foundation was created to provide a secure and permanent future for Project Gutenberg-tm and future generations. To learn more about the Project Gutenberg Literary Archive Foundation and how your efforts and donations can help, see Sections 3 and 4 and the Foundation web page at <http://www.pglaf.org>.

## Section 3. Information about the Project Gutenberg Literary Archive Foundation

The Project Gutenberg Literary Archive Foundation is a non profit 501(c)(3) educational corporation organized under the laws of the state of Mississippi and granted tax exempt status by the Internal Revenue Service. The Foundation's EIN or federal tax identification number is 64-6221541. Its 501(c)(3) letter is posted at <http://pglaf.org/fundraising>. Contributions to the Project Gutenberg Literary Archive Foundation are tax deductible to the full extent permitted by U.S. federal laws and your state's laws.

The Foundation's principal office is located at 4557 Melan Dr. S. Fairbanks, AK, 99712., but its volunteers and employees are scattered throughout numerous locations. Its business office is located at 809 North 1500 West, Salt Lake City, UT 84116, (801) 596-1887, email [business@pglaf.org](mailto:business@pglaf.org). Email contact links and up to date contact information can be found at the Foundation's web site and official page at <http://pglaf.org>

For additional contact information:

Dr. Gregory B. Newby  
Chief Executive and Director  
gbnewby@pglaf.org

#### Section 4. Information about Donations to the Project Gutenberg Literary Archive Foundation

Project Gutenberg-tm depends upon and cannot survive without wide spread public support and donations to carry out its mission of increasing the number of public domain and licensed works that can be freely distributed in machine readable form accessible by the widest array of equipment including outdated equipment. Many small donations (\$1 to \$5,000) are particularly important to maintaining tax exempt status with the IRS.

The Foundation is committed to complying with the laws regulating charities and charitable donations in all 50 states of the United States. Compliance requirements are not uniform and it takes a considerable effort, much paperwork and many fees to meet and keep up with these requirements. We do not solicit donations in locations where we have not received written confirmation of compliance. To SEND DONATIONS or determine the status of compliance for any particular state visit <http://pglaf.org>

While we cannot and do not solicit contributions from states where we have not met the solicitation requirements, we know of no prohibition against accepting unsolicited donations from donors in such states who approach us with offers to donate.

International donations are gratefully accepted, but we cannot make any statements concerning tax treatment of donations received from outside the United States. U.S. laws alone swamp our small staff.

Please check the Project Gutenberg Web pages for current donation methods and addresses. Donations are accepted in a number of other ways including including checks, online payments and credit card donations. To donate, please visit: <http://pglaf.org/donate>

#### Section 5. General Information About Project Gutenberg-tm electronic works.

Professor Michael S. Hart is the originator of the Project Gutenberg-tm concept of a library of electronic works that could be freely shared with anyone. For thirty years, he produced and distributed Project Gutenberg-tm eBooks with only a loose network of volunteer support.

Project Gutenberg-tm eBooks are often created from several printed editions, all of which are confirmed as Public Domain in the U.S. unless a copyright notice is included. Thus, we do not necessarily keep eBooks in compliance with any particular paper edition.

Most people start at our Web site which has the main PG search facility:

<http://www.gutenberg.net>

This Web site includes information about Project Gutenberg-tm,

including how to make donations to the Project Gutenberg Literary Archive Foundation, how to help produce our new eBooks, and how to subscribe to our email newsletter to hear about new eBooks.

